

# Dimplex

## AC3N, AC3RN, AC45N & AC6N Air Curtains

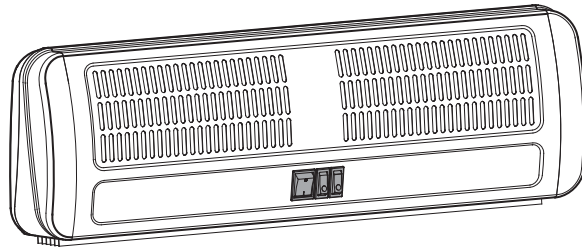

AC3N, AC45N & AC3RN

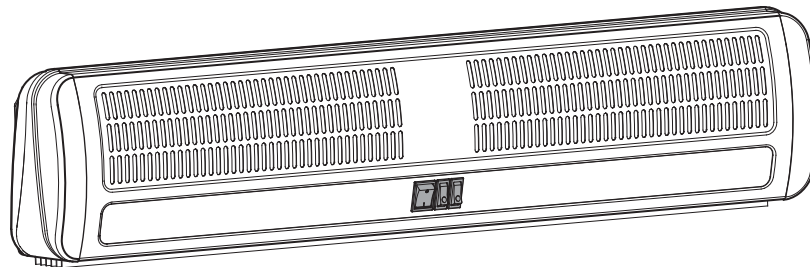

AC6N

1

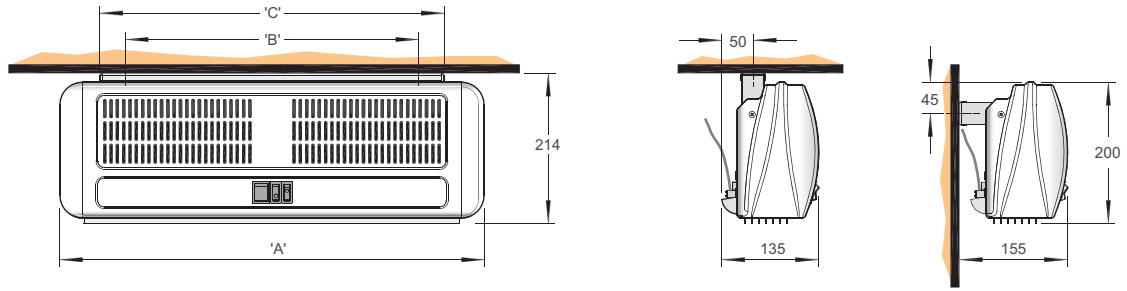

Model(s)	Watt	A	B	C
AC3N	3.0kw	605	424	492
AC45N	4.5kw	605	424	492
AC6N	6.0kw	905	721	756
AC3RN	3.0kw	605	424	492

2

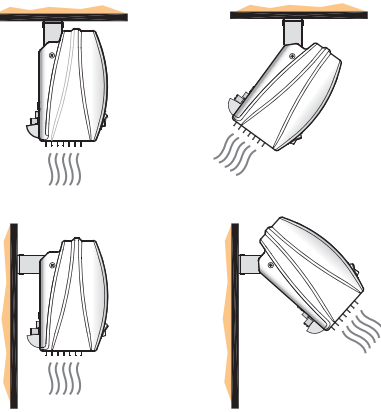

3

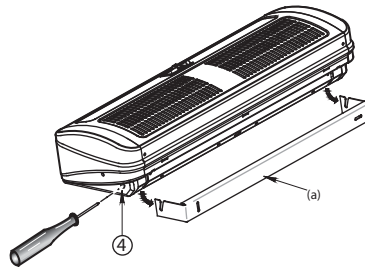

4

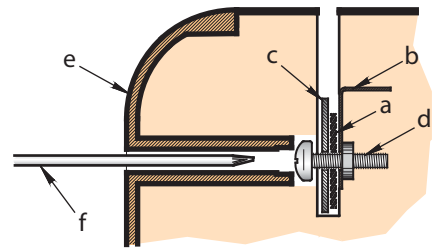

5

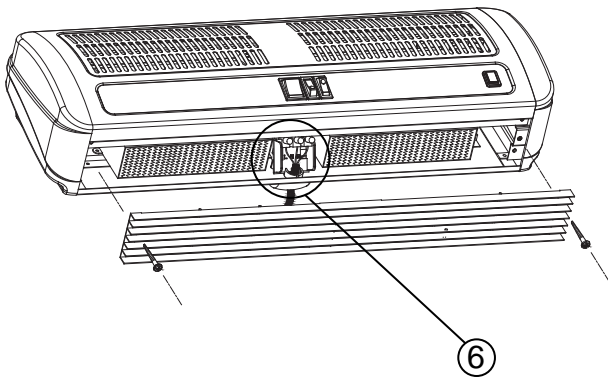

6

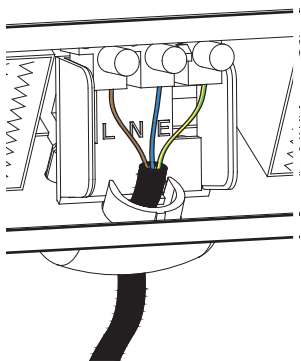

7a

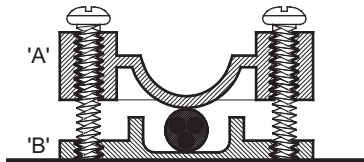

7b

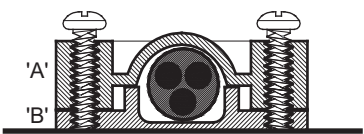

8

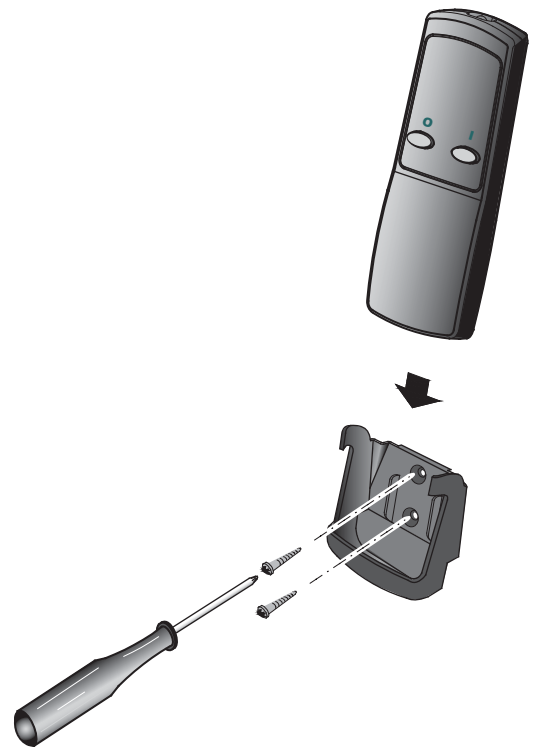

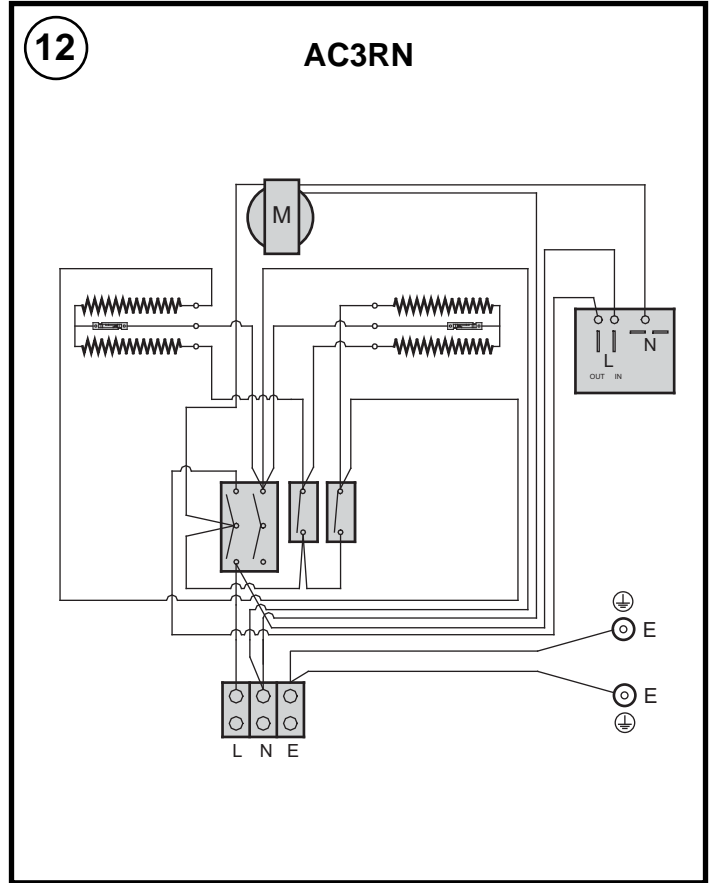
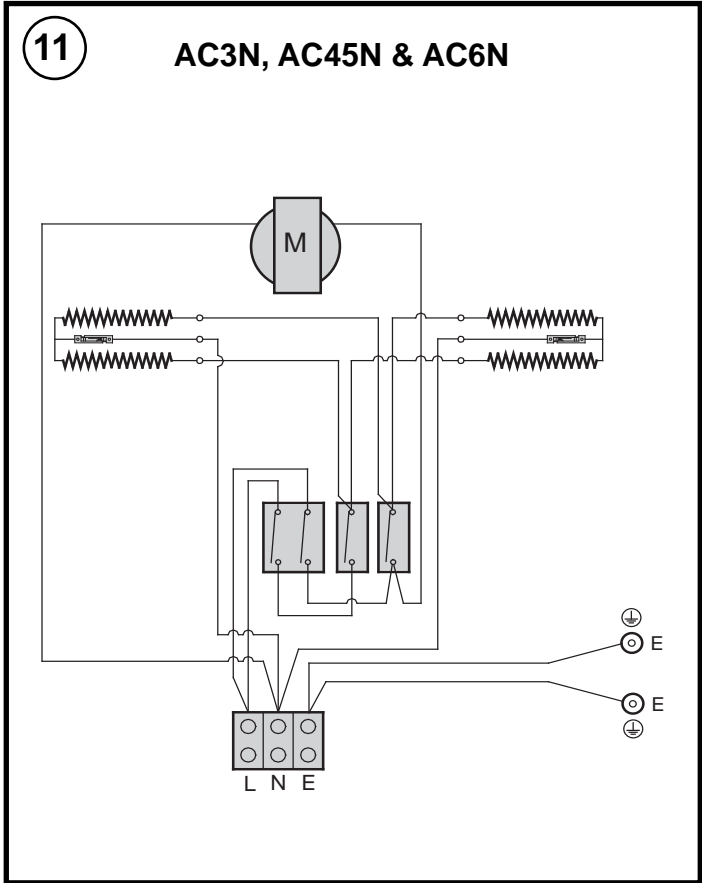
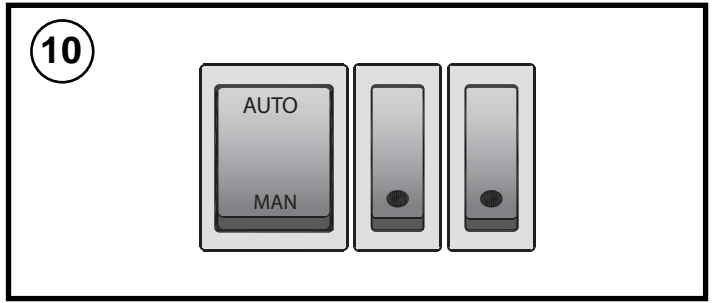
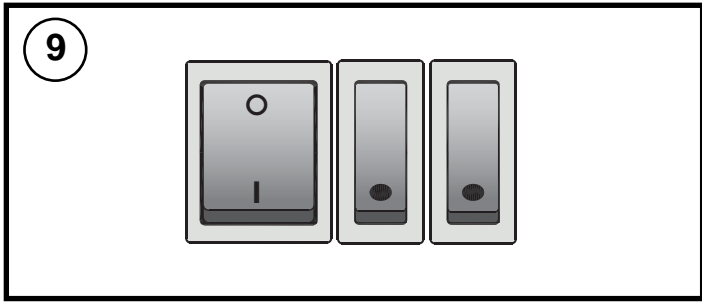

# AC Air Curtains

## Models : AC3N, AC45N, AC6N & AC3RN

IMPORTANT : THESE INSTRUCTIONS SHOULD BE READ CAREFULLY AND RETAINED FOR FUTURE REFERENCE

### IMPORTANT SAFETY ADVICE

DO NOT COVER OR OBSTRUCT the air inlet or outlet grille.

ENSURE THE APPLIANCE IS EARTHED.

Do not use this heater in areas where excessive dust exists.

This heater must not be located immediately above or below a fixed socket outlet or connection box.

Always disconnect supply before working on the product.

This product should be mounted safely to solid wall or ceiling surfaces only.

Ensure the supply cables are of adequate current carrying capacity and are protected by a suitable fuse.

If the appliance is mounted in a toilet or washroom, the appliance should be mounted such that no part of it can be touched by a person using a fixed bath or shower.

If the appliance is mounted in a toilet or washroom an isolating switch must be provided outside the washroom adjacent to the entrance door.

**Warning :** In order to avoid a hazard due to inadvertent resetting of the thermal cut-out, this appliance MUST NOT be supplied through an external switching device, such as a timer, or connected to a circuit that is regularly switched on and off by the utility.

### Electrical

The installation of this appliance should be carried out by a competent electrician and be in accordance with the current IEE wiring regulations.

### Fixing Positions

This appliance may be either wall-mounted or fixed to a ceiling - see Fig. 2 for various fixing positions and 'Installation' see section below, for details on fixing. Heaters may be mounted end to end for wide doorways.

### Installation

Using the wall mounting bracket as a guide (see 'a' in Fig. 3) mark off the hole positions on the wall or ceiling (see 'B' in Fig. 1). A minimum height of 1.8metres is required from floor to bracket. Fix the bracket in position by following steps as described under the heading 'Wall or Ceiling Mounting'.

### Wall or Ceiling Mounting

Solid brick or concrete block walls must be drilled and plugged (using a spirit level as a guide ensure bracket is level) and plugged with rawplugs supplied. The plug must be located in the solid part of the wall, not just in the plaster layer.

For panelled internal walls or ceilings, it is best to locate the studding, position the heater fixing bracket accordingly and use screws supplied. If it is not possible to locate the studding, use type M5 Rawplug inserts, making the 10mm holes with a drill rather than a bradawl or a screwdriver. Locate the heater on the mounting bracket ensuring that the pozi-head screws are fully engaged in the slots of the bracket.

It is important that the serrated metal washer (a) is located between the heater holding bracket (b) and the wall mounting bracket (c). Adjust heater to the required angle then firmly tighten the fixing screw (d) inside the endcap (e) using a cross-head screwdriver (f) as shown in Fig. 4.

### Electrical connection

Release the screws at either end of the air-outlet grille (see Fig. 5) to gain access to the terminals for connection of the supply cable - see Fig. 6.

Insert the mains cable down the outside of the back panel (not on inside) and through the rear entry cable clamp and make connection as shown in Fig. 6 (see also Fig. 7 for detailed views of cable clamp).

Fig. 7a shows the cable clamp detail for AC3N & AC3RN models.

Fig. 7b shows cable clamp detail for AC45N & AC6N models. Note : Part 'A' of cable clamp is flipped over to receive the larger cable.

Connection to fixed wiring should be made through an adjacent minimum 20 amp double-pole switch for AC3N, AC3RN & AC45N models.

Connection to fixed wiring should be made through an adjacent minimum 30 amp double-pole switch for AC6N model with a minimum separation of 3mm in each pole.

Re-secure the outlet grille.

Ensure that the air-curtain is securely fastened and that the supply cable is firmly clamped before operating the appliance.

### Operation (AC3N, AC45N & AC6N models)

Switch on electricity supply to the heater.

Switching the heater on the switch marked 'I' energises the blower.

Select 'I' and the smaller switches marked '●' as required (see Fig. 9)

Settings -	I	: Fan 'On'
	I + ●	: Half heat
	I + ● + ●	: Full heat

### Operation (AC3RN model)

Switch on electricity supply to the heater.

Select the switch position 'MAN' for Manual Operation.

Select the switch position 'AUTO' for Operation via the remote control.

Select the desired heat output using the smaller switches marked '●' (see Fig. 10).

To operate the remote control you must first select 'AUTO'. The heater may now be turned On or Off using the Remote Control (see Fig. 8).

Settings -	MAN	: Fan On
	AUTO	: Fan On or Off (using remote I / O)
	MAN / AUTO + ●	: Half heat
	MAN / AUTO + ● + ●	: Full heat

'AUTO' will default to 'OFF' if the remote control is not being used.

NOTE. Infra red technology is used for the remote control link, the range is 8 meters in line of sight.

If the remote control becomes lost, switch off at the mains supply for at least 30 seconds and select 'MAN' for Manual Operation.

### Remote Control (AC3RN model only)

Insert 2 off 1.5 volt AAA batteries into the remote control handset.

Switch the heater to 'AUTO' for automatic operation.

Press the I button to activate the heater, and O to turn off.

If the remote control does not operate the heater, first check batteries, then point remote directly at the heater before operating.

The remote control may be placed, when not in use, in the provided wall-mounted holster (see Fig. 8). Screws and rawplugs for wall fixing the holster are provided.

### Important Battery Information

Discard leaking batteries.

Dispose of batteries in the proper manner according to Provincial and local regulations. Any battery may leak electrolyte if mixed with a different battery type, if inserted incorrectly, if all the batteries are not replaced at the same time, if disposed of in a fire or if an attempt is made to charge a battery not intended to be recharged.

### Thermal Safety Cut-outs

The power supply to the heating elements will be interrupted if one or a combination of the following abnormal events occurs.

1. Air inlet or outlet grilles are obstructed.
2. Internal ventilation is impaired due to build up of dust and fluff.
3. Blower unit stalls.

**Note :** If the cut-out operates, the fan may continue to run impairing the performance of the heater. If this occurs, turn off unit immediately and follow the reset procedure below.

### Procedure for resetting cut-out

1. Disconnect power supply.
2. Determine what has caused the cut-out to operate and rectify.  
( Note : This should only be undertaken by competent persons with experience of repairing electrical appliances and in full knowledge of the possible hazards involved ).
3. After a short period of time (allowing the heater to cool down) the cut-out will reactivate allowing electrical supply to be returned to the heater thus permitting normal operation.

### Maintenance

**WARNING :** Disconnect the heater from the mains supply before carrying out maintenance.

This product is designed to require no maintenance. If operated in an extremely dusty environment it may however be necessary to carefully brush clean the air-inlet grille from time to time.

### Recycling



For electrical products sold within the European Community.

At the end of the electrical products useful life it should not be disposed of with household waste. Please recycle where facilities exist. Check with your Local Authority or retailer for recycling advice in your country.

### Cleaning

**WARNING: ALWAYS DISCONNECT POWER SUPPLY before cleaning the heater.**

Do not use detergents, abrasive cleaning powders or polish of any kind on the heater.

External appearance can be maintained by wiping occasionally with a damp cloth ; for stain removal, a weak soap solution can be applied with a cloth and the surface wiped dry. Care must be taken to avoid any moisture ingress into the product.

Ensure that dust or fluff does not accumulate inside the heater as this could lead to overheating of the element. Use a vacuum cleaner to remove any fluff which does accumulate.

### After Sales Service

Your product is guaranteed for one year from the date of purchase.

Within this period, we undertake to repair or exchange this product free of charge (subject to availability) provided it has been installed and operated in accordance with these instructions.

Your rights under this guarantee are additional to your statutory rights, which in turn are not affected by this guarantee.

Should you require after sales service information or assistance with this product please go to [www.dimplex.co.uk](http://www.dimplex.co.uk) where you will find our self help guide by clicking on "After Sales" or ring our Helpdesk on 0845 600 5111 (UK) or 8424833 (R.O.I.).

Spare parts are also available on the website [www.dimplex.co.uk](http://www.dimplex.co.uk)

Please retain your receipt as proof of purchase.

Dimplex  
Millbrook House  
Grange Drive  
Hedge End  
Southampton  
Hampshire SO30 2DF

Tel. 0845 600 5111  
Fax. 01489 773050  
Website [www.dimplex.co.uk](http://www.dimplex.co.uk)  
Republic of Ireland Tel. 01 8424833