



# CorePro LED PLC

## CorePro LED PLC CorePro LED PLC 8.5W 840 2P G24d-3

Philips CorePro LED PLC is the ideal uplampping solution for downlights in a wide range of general lighting applications. It integrates a LED light source into a traditional fluorescent form factor to offer superb energy savings over a lifetime that's twice as long as fluorescent alternatives.

### Product data

General Information	
Cap-Base	G24D-3 [ G24d-3]
Nominal Lifetime (Nom)	30000 h
Switching Cycle	50000X
B50L70	30000 h

Light Technical	
Color Code	840 [ CCT of 4000K]
Luminous Flux (Nom)	1000 lm
Luminous Flux (Rated) (Nom)	1000 lm
Correlated Color Temperature (Nom)	4000 K
Color Consistency	<6
Color Rendering Index (Nom)	83
LLMF At End Of Nominal Lifetime (Nom)	70 %

Operating and Electrical	
Input Frequency	50 to 60 Hz
Power (Rated) (Nom)	8.5 W
Lamp Current (Max)	43 mA
Lamp Current (Min)	33 mA

Starting Time (Nom)	0.5 s
Warm Up Time to 60% Light (Nom)	0.5 s
Power Factor (Nom)	0.9
Voltage (Nom)	220-240 V

Temperature	
T-Ambient (Max)	35 °C
T-Ambient (Min)	-20 °C
T-Storage (Max)	65 °C
T-Storage (Min)	-40 °C
T-Case Maximum (Nom)	75 °C

Controls and Dimming	
Dimmable	No

Mechanical and Housing	
Product Length	100 mm

Approval and Application	
Energy Saving Product	Yes

# CorePro LED PLC

<b>Energy Efficiency Label (EEL)</b>	A+
<b>Approval Marks</b>	TUV CE marking RoHS compliance KEMA Keur certificate
<b>Energy Consumption kWh/1000 h</b>	11 kWh
<b>Product Data</b>	
<b>Full product code</b>	871869654125800
<b>Order product name</b>	CorePro LED PLC CorePro LED PLC 8.5W 840 2P G24d-3

<b>EAN/UPC - Product</b>	8718696541258
<b>Order code</b>	929001201302
<b>Numerator - Quantity Per Pack</b>	1
<b>Numerator - Packs per outer box</b>	10
<b>Material Nr. (12NC)</b>	929001201302
<b>Net Weight (Piece)</b>	0.090 kg

## Warnings and Safety

- NOTES: The overall energy efficiency and light distribution of any installation that uses these lamps are determined by the design of the installation.

## Dimensional drawing

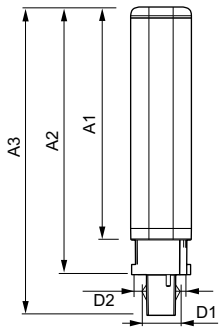

LEDtube PLC 8.5W G24d-3/840 2P

Product	D1	D2	A1	A2	A3
CorePro LED PLC CorePro LED PLC 8.5W 840 2P G24d-3	24.3 mm	28.4 mm	128.8 mm	148 mm	170.6 mm

## Photometric data

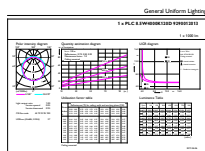

General Uniform Lighting  
PLC 100mm 9W G24Q-3 840 1000lm  
Product Information 13 Photo Lighting 8.1 Page 11

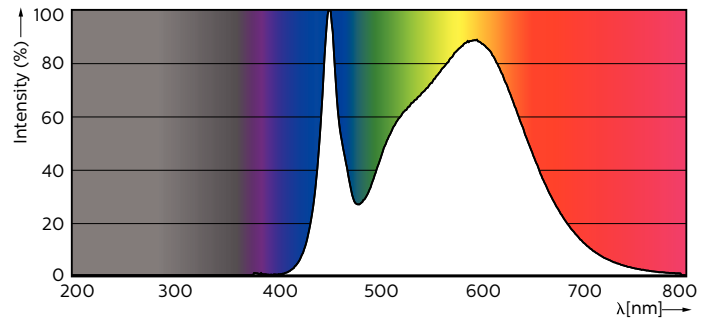

LEDtube PLC 100mm 9W G24Q-3 840 1000lm

# CorePro LED PLC

## Photometric data

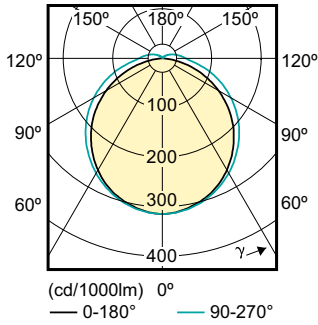

PLC /830, /840

## Lifetime

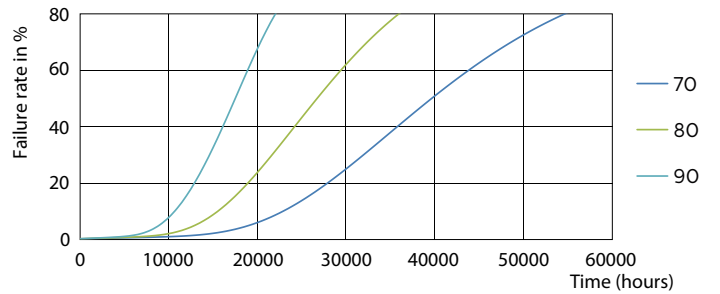
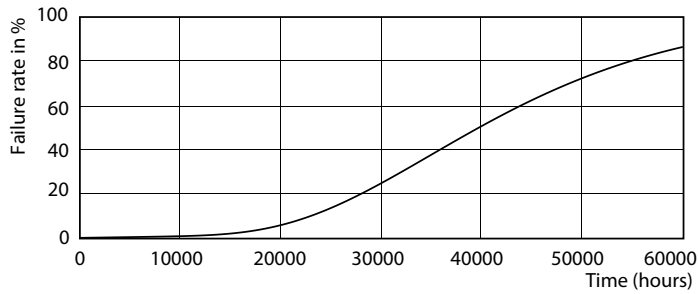

LEDtube PLC 100mm 9W G24D-3 830 950lm

LEDtube PLC 100mm 9W G24D-3 830 950lm

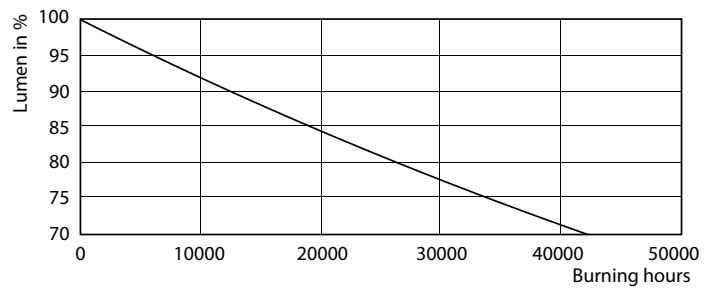
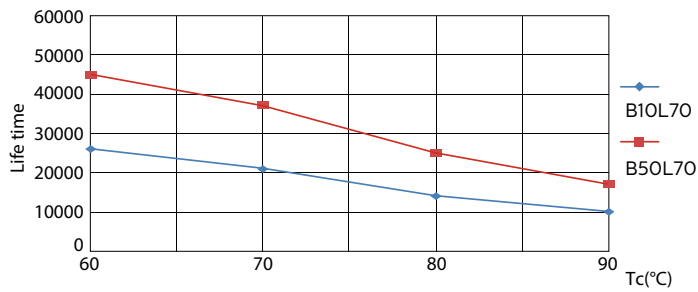

LEDtube PLC 100mm 9W G24D-3 830 950lm

LEDtube PLC 100mm 9W G24D-3 830 950lm

## CorePro LED PLC

### Lifetime

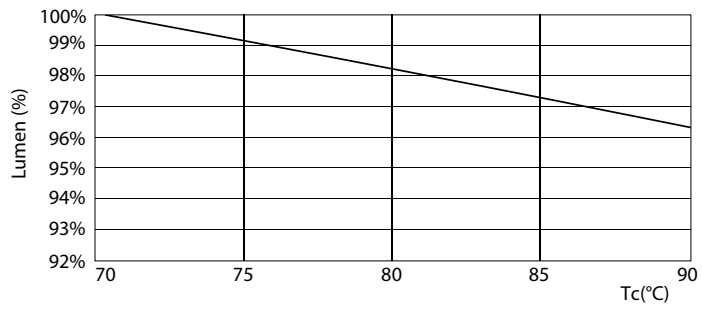

LEDtube PLC 100mm 9W G24D-3 830 950lm

