



Wiring Devices

Catalogue 2017

www.schneider-electric.co.uk

Life Is On

Schneider
Electric

Contents

- **Section 1 Page 4**
Ultimate
Ultimate screwless, Ultimate flat plate, Ultimate low profile, Ultimate slimline
- **Section 2 Page 104**
Lisse Screwless Deco
Lisse curved screwless decorative
- **Section 3 Page 122**
Lisse
Lisse curved white moulded
- **Section 4 Page 142**
Exclusive
Exclusive square edge white moulded, Exclusive metal clad
- **Section 5 Page 168**
T2 Ceiling Accessories
Ceiling accessories, back boxes
- **Section 6 Page 184**
Weatherproof
IP55, IP66, Kavacha
- **Section 7 Page 188**
56 Series
Industrial switchgear
- **Section 8 Page 200**
Desk Units
IDU - In-Desk Units, FDU - Flush Desk Units, PTU - Pop Up Tower Units, ODU - On-Desk Units,
UDU - Under Desk Units & Select Custom Modules
- **Section 9 Page 210**
Occupancy & Presence detection
ARGUS presence detector system, Stand-alone Occupancy sensors, Clipsal C-Bus

Ultimate screwless



Ultimate flat plate



Ultimate low profile



Ultimate slimline



Lisse Screwless Deco



Lisse curved white moulded

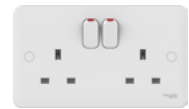

Exclusive square edge white moulded



Exclusive metal clad



Ceiling accessories



back boxes



IP55



IP66



Kavacha



Industrial switchgear



Desk units



ARGUS presence detector system



Stand-alone Occupancy sensors



Clipsal C-Bus





Ultimate

A family of styles brought together by design

From the understated design of slimline white moulded to chic screwless flat plate, Ultimate wiring accessories provide sophisticated styles to suit all interiors.

Packed with innovative technical features and time saving installation benefits, Ultimate wiring accessories are an essential compliment for every installation.



Screwless Flat Plate:

Indulge in ultimate luxury with seamless lines and no visible screws. Combining fashion and functionality, the Ultimate Screwless flat plate range provides the perfect solution for customers looking for a cutting edge modern design with the latest installation features and benefits.



Flat Plate:

Add that special touch to any interior – Ultimate flat plate combines superior engineering with 1.5mm ultra slim, ultra chic flat plate design. The comprehensive array of finishes ensures that you will always find the perfect compliment to your design.



Low Profile:

Ultimate low profile offers a contemporary and refreshing twist on traditional designs with its softly curved edge and quality metal finishes. With its forgiving 5mm plate depth to accommodate uneven wall surfaces, it is also an ideal solution for remodel and renovation projects.



Slimline White Moulded:

Offering a stylish, modern alternative, Ultimate slimline white moulded meets the highest specification to enhance any installation with a full compliment of Part M and Essential Supply solutions.

Unparalleled Design Quality

Ultra slim construction: Minimal back projection for an easy fit into standard mounting boxes



Comprehensive product range: Wide choice of devices to satisfy installation requirements



Contemporary aesthetics: Sleek finish with screw cap covers and tactile switch action with rounded rockers

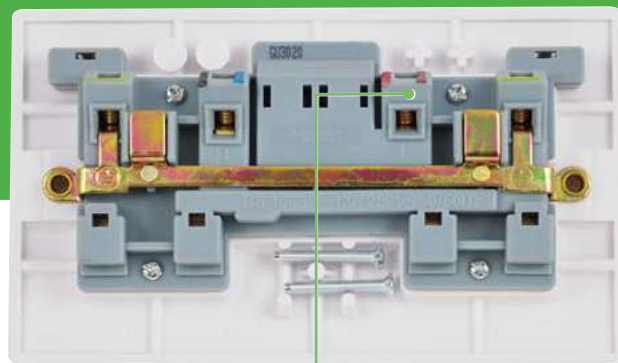
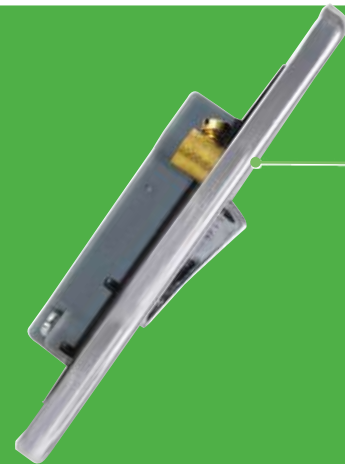

Ease of installation: Colour-coded, in-line and angled socket terminals for clear visibility

Easier Ordering

Whether you are interested in ULTIMATE Slimline, Screwless Flat Plate, Flat Plate or Low Profile, simplify your ordering experience with a common part reference framework across the entire Ultimate range - saving you time and avoiding hassle.

- 1 Plate switches
- 2 20AX switches & flex outlets
- 3 Sockets
- 4 50A switches & 45A control units
- 5 Fused connection units
- 6 Dimmers
- 7 Shaver sockets & data communication
- 8 Blank plates

switched
unswitched
number of gangs
number of ways

- SS Stainless Steel
- PC Polished Chrome
- PW Painted White
- PN Pearl Nickel
- BN Black Nickel
- LK Painted Black
- CLR Transparent
- BK Piano Black
- WH Gloss White

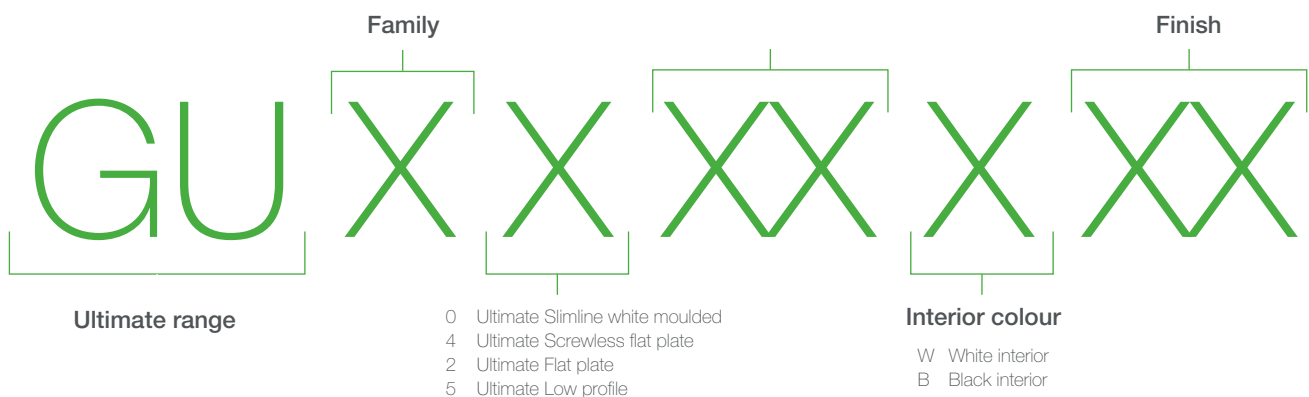

Grid Solutions

The comprehensive ULTIMATE grid system has been specially designed to bring beauty and style to commercial and residential spaces.

With a vast array of modules to choose from, including data and communications, ULTIMATE grid can provide the ideal solution for highly technical specifications

Simple as 1, 2, 3...



Fit installation box and mounting grid. Pull through cables, cut and strip to length.



Terminate each cable to the appropriate switch (clear terminal markings).



Once wired, the modules simply but securely clip into the mounting grid.



Finally after decorating, fit the cover plate.



Front plates are available in a variety of finishes.

Rocker Printing and Engraving

From hob to wine cooler, the ULTIMATE range offer both printing and engraving options for a truly tailored wiring solution. Custom options available.

ULTIMATE Screwless Flat Plate

The ULTIMATE Screwless Flat Plate range provides one of the most comprehensive choices of beautifully crafted, sophisticated fittings on the market. With only a mere 1.5mm front plate depth, this cutting edge screwless design blends seamlessly onto wall surfaces

The wide selection of finish choices within the range will ensure that you always find your perfect match. Choose from Stainless Steel, Polished chrome, Pearl Nickel, Black Nickel, Painted White, Polished Brass, Gloss White, Textured Black, or Transparent

Independent mechanical & electrical connection for enhanced safety

Ultra slim profile: 1.5mm Plate thickness provides a design-led alternative to traditional accessories

Large footprint: Provides extra strength and reduces the need for additional decorating

A choice of 12 finish combinations

Tamperproof front plates with a 4 Point front plate secure connection

Inline angled terminals for easy access during installation

Plated earth straps provide corrosion free life

Two sets of fixing screws to accommodate differing mounting box depths

Finish Selection

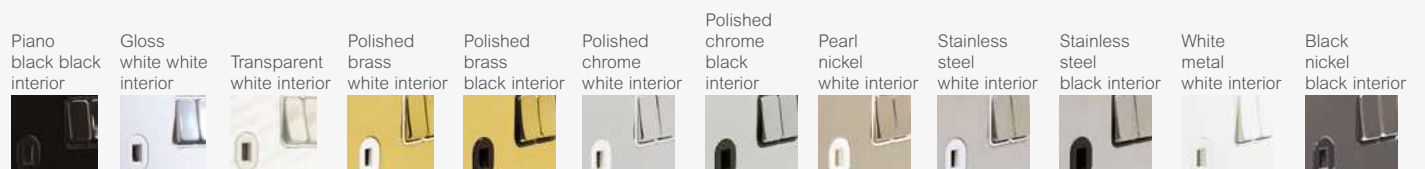

ULTIMATE Collection

A high quality range of Screwless Flat Plate available in bespoke made-to-order finishes to match your project needs.

Part code structure:

- 1 Plate switches
 - 2 20AX switches & flex outlets
 - 3 Sockets
 - 4 50A switches & 45A control units
 - 5 Fused connection units
 - 6 Dimmers
 - 7 Shaver sockets & data communication
 - 8 Blank plates
- switched
unswitched
number of gangs
number of ways

- NB Nickel Bright
- DB Dark Bronze
- GB Gloss Black
- JB Jet Black
- AB Antique Brass
- BW Bright White

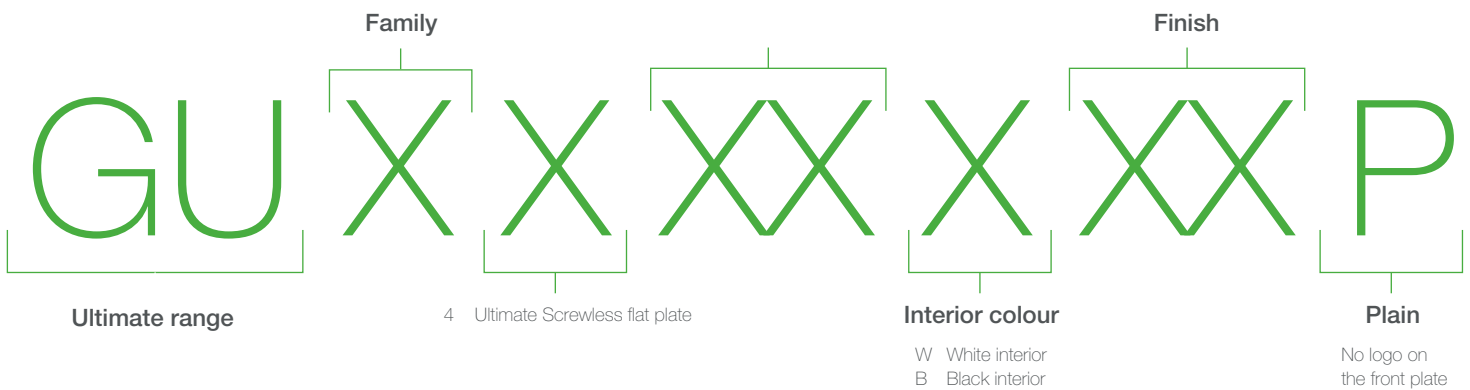

Finishes:



Nickel Bright (NB)
Designed to suit contemporary and traditional settings



Dark Bronze (DB)
Designed to enhance the historic period elegance of your setting



Gloss Black (GB)
Strong and chic effect for interiors



Jet Black (JB)
Elegant matt black brings understated class to your room design



Antique Brass (AB)
A timelessly elegant finish, blending the classic and the contemporary for a superb effect



Bright White (BW)
Our super white finish will suit any design scheme you choose



Ultimate Screwless Flat Plate



Solutions for today and tomorrow

The rapid expansion of entertainment and communication devices requires an ever increasing diversity of wiring accessories to power, access and control the technology people use everyday.

Choosing Ultimate accessories not only provides all of the functions needed in the modern home but a choice of styles and finishes to match to the mood and use of every room.



USB Solution

This contemporary range now comes with a USB charging solution, offering a simple solution to a modern day issue.



Let creativity reign with the Ultimate Screwless Transparent range.

Whether matching a favourite wallpaper to create a seamless, unblemished design, or inserting a unique family photo, your customers can pick and choose the perfect image to fit their accessories.

To create their own personal design, Homeowners can download the Schneider Electric Home Touch app which is available for Apple iOS and Android platforms from the App and Google Play stores.

Specification Highlights



Dedicated Key Card Switch to support your Specification project requirements



Glow in the dark frame for easier accessory identification in the night hours. Wire free – simply clip in place at standard profile thickness



50A rated plate switches for switching appliances with higher current ratings, such as heaters, cookers and commercial refrigerating units



16AX switch rating across all plate switches offers a future-proofed lighting solution to accommodate increased load requirements & fluorescent lighting demands



Tamperproof front plates clip securely in to the mounting frames to added safety and protection. (Requires use of a tool for removal BS 7671)



Colour coded in-line terminals as well as a colour balanced back moulding makes terminals easily identifiable during installation, particularly in lower light levels

Socket outlets

13A 1 gang unswitched



GU3450BSS

Product code	Description	Pack qty
GU3450*SS	Stainless steel	1
GU3450*PC	Polished chrome	1
GU3450WPW	Painted white with white interior	1
GU3450WPN	Pearl nickel with white interior	1
GU3450BBN	Black nickel with black interior	1
GU3450BPB	Polished brass with black interior	1

- **Standard of compliance:** BS 1363 (13A)
- **Mounting box:** Minimum 25mm deep
- **Fixing screws:** M3.5 x 25mm and 30mm
- **Plate dimensions:** 88 x 88mm (1 gang) 88 x 148mm (2 gang)

13A 2 gang unswitched



GU3460BSS

Product code	Description	Pack qty
GU3460*SS	Stainless steel	1
GU3460*PC	Polished chrome	1
GU3460WPW	Painted white with white interior	1
GU3460WPN	Pearl nickel with white interior	1
GU3460BBN	Black nickel with black interior	1
GU3460BPB	Polished brass with black interior	1

13A 1 gang single-pole switched



GU3410BSS

Product code	Description	Pack qty
GU3410*SS	Stainless steel	1
GU3410*PC	Polished chrome	1
GU3410WPW	Painted white with white interior	1
GU3410WPN	Pearl nickel with white interior	1
GU3410BBN	Black nickel with black interior	1
GU3410BPB	Polished brass with black interior	1
GU3410CLR	Transparent with white interior	1

13A 1 gang double-pole switched



GU3410DBSS

Product code	Description	Pack qty
GU3410D*SS	Stainless steel	1
GU3410D*PC	Polished chrome	1
GU3410DWPW	Painted white with white interior	1
GU3410DWPN	Pearl nickel with white interior	1
GU3410DBBN	Black nickel with black interior	1
GU3410BPB	Polished brass with black interior	1
GU3410DWWH	Gloss white with white interior	1
GU3410DBBK	Piano black with black interior	1

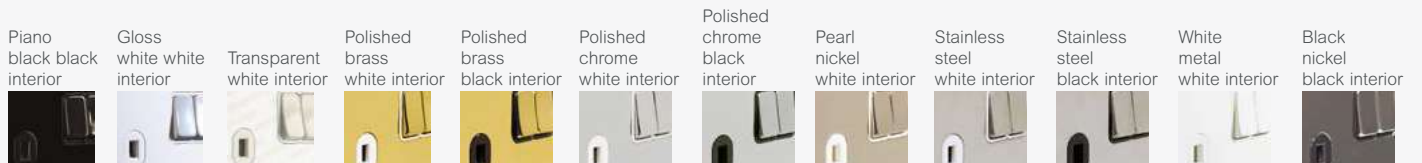

Socket outlets continued

13A 1 gang double-pole switched with neon



GU3411DBSS

Product code	Description	Pack qty
GU3411D*SS	Stainless steel	1
GU3411D*PC	Polished chrome	1
GU3411DWPW	Painted white with white interior	1
GU3411DWPN	Pearl nickel with white interior	1
GU3411DBBN	Black nickel with black interior	1
GU3411DBPB	Polished brass with black interior	1

- **Standard of compliance:**
BS 1363 (13A)
- **Mounting box:**
Minimum 25mm deep
- **Fixing screws:**
M3.5 x 25mm and 30mm
- **Plate dimensions:**
88 x 148mm (2 gang)

13A 2 gang single-pole switched



GU3420BSS

Product code	Description	Pack qty
GU3420*SS	Stainless steel	1
GU3420*PC	Polished chrome	1
GU3420WPW	Painted white with white interior	1
GU3420WPN	Pearl nickel with white interior	1
GU3420BBN	Black nickel with black interior	1
GU3420BPB	Polished brass with black interior	1
GU3420CLR	Transparent with white interior	1

- **Standard of compliance:**
BS 1363 (13A)
- **Mounting box:**
Minimum 25mm deep
- **Fixing screws:**
M3.5 x 25mm and 30mm
- **Plate dimensions:**
88 x 148mm (2 gang)

13A 2 gang double-pole switched



GU3420DBSS

Product code	Description	Pack qty
GU3420D*SS	Stainless steel	1
GU3420D*PC	Polished chrome	1
GU3420DWPW	Painted white with white interior	1
GU3420DWPN	Pearl nickel with white interior	1
GU3420DBBN	Black nickel with black interior	1
GU3420DBPB	Polished brass with black interior	1
GU3420DWWH	Gloss white with white interior	1
GU3420DBBK	Piano black with black interior	1

13A 2 gang double-pole switched with neons



GU3421DBSS

Product code	Description	Pack qty
GU3421D*SS	Stainless steel	1
GU3421DWPW	Painted white with white interior	1
GU3421DWPN	Pearl nickel with white interior	1
GU3421DBBN	Black nickel with black interior	1
GU3421DBPB	Polished brass with black interior	1

13A 2 gang double-pole switched with clean earth & outboard rockers



GU3431BSS

Product code	Description	Pack qty
GU3431*SS	Stainless steel	1
GU3431*PC	Polished chrome	1
GU3431WPW	Painted white with white interior	1
GU3431WWH	Gloss white with white interior	1

Socket outlets continued

13A 2 gang double-pole switched with clean earth & red neon outboard rockers



GU3434BSS

Product code	Description	Pack qty
GU3434*SS	Stainless steel	1
GU3434WPC	Polished chrome with white interior	1

13A 2 gang switched USB socket



GGBGU34202USBBPC

Product code	Description	Pack qty
GGBGU34202USBBPC	Polished chrome with black interior	1
GGBGU34202USBWPC	Polished chrome with white interior	1
GGBGU34202USBBSS	Stainless steel with black interior	1
GGBGU34202USBWSS	Stainless steel with white interior	1
GGBGU34202USBWPW	Painted white with white interior	1
GGBGU34202USBBPB	Polished brass with black interior	1
GGBGU34202USBWPN	Pearl nickel with white interior	1
GGBGU34202USBBBN	Black nickel with black interior	1

- **Mounting box:**
35mm without spacer or 25mm with spacer

(Spacer supplied with product, not available separately)

2A unswitched round pin



GU3470BSS

Product code	Description	Pack qty
GU3470*SS	Stainless steel	1
GU3470*PC	Polished chrome	1
GU3470WPW	Painted white with white interior	1
GU3470WPN	Pearl nickel with white interior	1
GU3470BBN	Black nickel with black interior	1
GU3470BPB	Polished brass with black interior	1

- **Standard of compliance:**
BS 546
- **Mounting box:**
Minimum 25mm deep
- **Fixing screws:**
M3.5 x 25mm and 30mm
- **Plate dimensions:**
88 x 88mm

5A unswitched round pin



GU3480BSS

Product code	Description	Pack qty
GU3480*SS	Stainless steel	1
GU3480*PC	Polished chrome	1
GU3480WPW	Painted white with white interior	1
GU3480WPN	Pearl nickel with white interior	1
GU3480BBN	Black nickel with black interior	1
GU3480BPB	Polished brass with black interior	1
GU3480WWH	Gloss white	1

Socket outlets continued

15A switched round pin



GU3490BSS

Product code	Description	Pack qty
GU3490*SS	Stainless steel	1
GU3490*PC	Polished chrome	1
GU3490WPW	Painted white with white interior	1
GU3490WPN	Pearl nickel with white interior	1
GU3490BBN	Black nickel with black interior	1
GU3490BPB	Polished brass with black interior	1

Media plates

Stacked with 2 x 2 gang double-pole socket outlets & 4 x 2 module euro



GU34204DMPBSS

Product code	Description	Pack qty
GU34204DMP*SS	Stainless steel	1
GU34204DMP*PC	Polished chrome	1
GU34204DMPWPW	Painted white with white interior	1
GU34204DMPWPN	Pearl nickel with white interior	1
GU34204DMPBBN	Black nickel with black interior	1
GU34204DMPBPB	Polished brass with black interior	1
GGBSB4724M	Stacked back box	1

- **Standard of compliance:**
BS 5733
BS 1363-2
- **Fixing screws:**
M3.5 x 25mm and
30mm
- **Mounting box:**
47mm deep
- **Plate dimensions:**
296 x 86mm (in-line)
296 x 176mm
(stacked)

In-line with 1 x 2 gang double-pole sockets & 2 x 2 module euro



GU34202DMPBSS

Product code	Description	Pack qty
GU34202DMP*SS	Stainless steel	1
GU34202DMP*PC	Polished chrome	1
GU34202DMPWPW	Painted white with white interior	1
GU34202DMPWPN	Pearl nickel with white interior	1
GU34202DMPBBN	Black nickel with black interior	1
GU34202DMP*PB	Polished brass with black interior	1
GGBSB4722M	In-line back box	1

- Euro modules plates compatible with Schneider Electric euro modules.
- **Note:**
Modules from other suppliers may not be compatible, it is advised to check suitability.

Plate switches

16AX 1 gang 2 way



GU1412BSS

Product code	Description	Pack qty
GU1412*SS	Stainless steel	1
GU1412*PC	Polished chrome	1
GU1412WPW	Painted white with white interior	1
GU1412WPN	Pearl nickel with white interior	1
GU1412BBN	Black nickel with black interior	1
GU1412BPB	Polished brass with black interior	1
GU1412BBK	Piano black with black interior	1
GU1412WWH	Gloss white with white interior	1
GU1412CLR	Transparent with white interior	1
GU1400F	1 gang glow in the dark frame	10

- **Standard of compliance:** BS EN 60669-1
- **Mounting box:** 16mm deep (1-2 gang)
- **Fixing screws:** M3.5 x 25mm and 30mm
- **Plate dimensions:** 88 x 88mm (1-3 gang)



16AX 1 gang intermediate



GU1414BSS

Product code	Description	Pack qty
GU1414*SS	Stainless steel	1
GU1414*PC	Polished chrome	1
GU1414WPW	Painted white with white interior	1
GU1414WPN	Pearl nickel with white interior	1
GU1414BBN	Black nickel with black interior	1
GU1414BPB	Polished brass with black interior	1

- **Technical notes:** The glow in the dark frame discreetly signposts the profile of the switch and aids switch location.

16A 1 gang 2 way retractive



GU1412RBSS

Product code	Description	Pack qty
GU1412R*SS	Stainless steel	1
GU1412R*PC	Polished chrome	1
GU1412RWPW	Painted white with white interior	1
GU1412RWPN	Pearl nickel with white interior	1
GU1412RBBN	Black nickel with black interior	1
GU1412RBPB	Polished brass with black interior	1

Spare Gasket Frame

Product code	Description	Pack qty
GU1401F	1G GASKET FRAME - clear	1
GU1401FW	1G GASKET FRAME - white	1

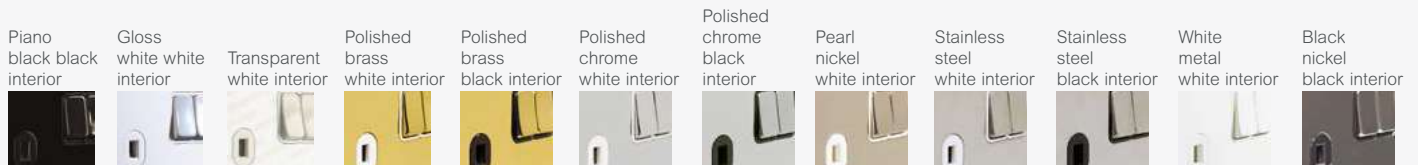

16AX 2 gang 2 way



GU1422BSS

Product code	Description	Pack qty
GU1422*SS	Stainless steel	1
GU1422*PC	Polished chrome	1
GU1422WPPW	Painted white with white interior	1
GU1422WPNP	Pearl nickel with white interior	1
GU1422BBBN	Black nickel with black interior	1
GU1422BPBP	Polished brass with black interior	1
GU1422BBBK	Piano black with black interior	1
GU1422WWWH	Gloss white with white interior	1
GU1422CLCR	Transparent with white interior	1

16AX 3 gang 2 way

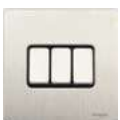

GU1432BSS

Product code	Description	Pack qty
GU1432*SS	Stainless steel	1
GU1432*PC	Polished chrome	1
GU1432WPPW	Painted white with white interior	1
GU1432WPNP	Pearl nickel with white interior	1
GU1432BBBN	Black nickel with black interior	1
GU1432BPBP	Polished brass with black interior	1
GU1432CLCR	Transparent with white interior	1

16AX 4 gang 2 way

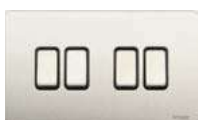

GU1442BSS

Product code	Description	Pack qty
GU1442*SS	Stainless steel	1
GU1442*PC	Polished chrome	1
GU1442WPPW	Painted white with white interior	1
GU1442WPNP	Pearl nickel with white interior	1
GU1442BBBN	Black nickel with black interior	1
GU1442BPBP	Polished brass with black interior	1

16AX 6 gang 2 way

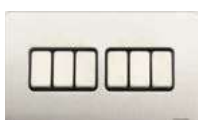

GU1462BSS

Product code	Description	Pack qty
GU1462*SS	Stainless steel	1
GU1462*PC	Polished chrome	1
GU1462WPPW	Painted white with white interior	1
GU1462WPNP	Pearl nickel with white interior	1
GU1462BBBN	Black nickel with black interior	1
GU1462BPBP	Polished brass with black interior	1

Plate switches continued

10A triple pole isolator



GU1413BSS

Product code	Description	Pack qty
GU1413*SS	Stainless steel	1
GU1413*PC	Polished chrome	1
GU1413WPW	Painted white with white interior	1
GU1413WPN	Pearl nickel with white interior	1
GU1413BBN	Black nickel with black interior	1
GU1413BPB	Polished brass with black interior	1
GU1413BBK	Piano black	1

- **Standard of compliance:**
BS EN 60669-1
BS EN 60947-3
(GU1413***)
- **Mounting box:**
16mm deep (1-2 gang)
25mm deep (3-6 gang)
- **Fixing screws:**
M3.5 x 25mm and
30mm
- **Plate dimensions:**
88 x 88mm (1-3 gang),
88 x 148mm (4-6 gang)

PIR plate switches

1 gang 1way PIR with override



GUPA1411BSS

Product code	Description	Pack qty
GUPA1411BSS	Stainless steel with black interior	1

- **Standard of compliance:**
BS EN 60669-2-1
- **Mounting box:**
16mm deep
- **Fixing screws:**
M3.5 x 25mm and
30mm
- **Plate dimensions:**
88 x 88mm
- **Technical Notes:**
Operating distance =
6M at 45° horizontal.

1 gang 1 way PIR



GUP1411BSS

Product code	Description	Pack qty
GUP1411BSS	Stainless steel with black interior	1

- Time setting: 15 sec -
30 mins.
10 - 2000 Lux.
2 wire connection.

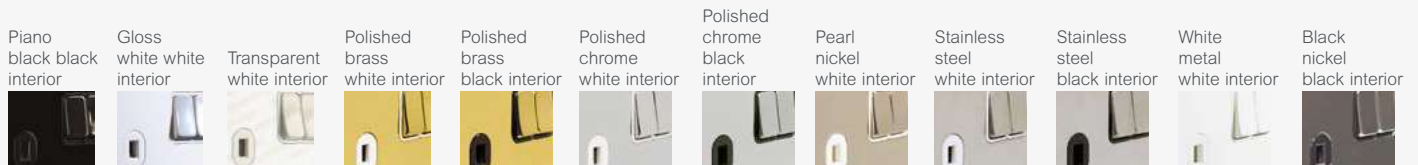

Toggle switches

16AX 1 gang 2 way



GU1412TSS

Product code	Description	Pack qty
GU1412TSS	Stainless steel	1
GU1412TPC	Polished chrome	1
GU1412TPW	Painted white	1
GU1412TPN	Pearl nickel	1
GU1412TBN	Black nickel	1
GU1412TPB	Polished brass	1
GU1412TCLR	Transparent with white interior	1

- **Standard of compliance:**
BS EN 60669-1
- **Mounting box:**
16mm deep
(1-2 gang)
- **Fixing screws:**
M3.5 x 25mm and
30mm
- **Plate dimensions:**
88 x 88mm (1-3 gang)

16AX 1 gang intermediate



GU1414TSS

Product code	Description	Pack qty
GU1414TSS	Stainless steel	1
GU1414TPC	Polished chrome	1
GU1414TPW	Painted white	1
GU1414TBN	Black nickel	1
GU1414TPB	Polished brass	1

16AX 2 gang 2 way



GU1422TSS

Product code	Description	Pack qty
GU1422TSS	Stainless steel	1
GU1422TPC	Polished chrome	1
GU1422TPW	Painted white	1
GU1422TPN	Pearl nickel	1
GU1422TBN	Black nickel	1
GU1422TPB	Polished brass	1
GU1422TCLR	Transparent with white interior	1

16AX 3 gang 2 way



GU1432TSS

Product code	Description	Pack qty
GU1432TSS	Stainless steel	1
GU1432TPC	Polished chrome	1
GU1432TPW	Painted white	1
GU1432TPN	Pearl nickel	1
GU1432TBN	Black nickel	1
GU1432TPB	Polished brass	1

- **Standard of compliance:**
BS EN 60669-1
- **Mounting box:**
35mm deep (3 gang)
25mm deep (4 gang)
- **Fixing screws:**
M3.5 x 25mm and
30mm
- **Plate dimensions:**
88 x 88mm (3 gang)
88 x 148mm (4 gang)

16AX 4 gang 2 way



GU1442TSS

Product code	Description	Pack qty
GU1442TSS	Stainless steel	1
GU1442TPC	Polished chrome	1
GU1442TPW	Painted white	1
GU1442TPN	Pearl nickel	1
GU1442TBN	Black nickel	1
GU1442TPB	Polished brass	1

Key card switch

32A single-pole key card switch with 30 second time delay



GU1412KBSS

Product code	Description	Pack qty
GU1412K*SS	Stainless steel	1
GU1412K*PC	Polished chrome	1
GU1412KWPW	Painted white with white interior	1
GU1412KWPN	Pearl nickel with white interior	1
GU1412KBBN	Black nickel with black interior	1
GU1412KBPB	Polished brass with black interior	1

- **Standard of compliance:**
BS EN 60669-1
- **Mounting box:**
47mm deep
- **Fixing screws:**
M3.5 x 25mm and 30mm
- **Plate dimensions:**
88 x 88mm
- **Technical Notes:**
Non reader type, accepts any card (not supplied). Requires L&N connection. Will accept cards up to 85 x 53mm.

Dimmer switches

1 gang 2 way 400W/VA mains & low voltage



GU6412CSS

Product code	Description	Pack qty
GU6412CSS	Stainless steel	1
GU6412CPC	Polished chrome	1
GU6412CPW	Painted white	1
GU6412CPN	Pearl nickel	1
GU6412CBN	Black nickel	1
GU6412CPB	Polished brass	1

- **Standard of compliance:**
BS EN 669-2-1
- **Mounting box:**
25mm deep (1-2 gang)
35mm deep (3-4 gang)
- **Fixing screws:**
M3.5 x 25mm and 30mm
- **Plate dimensions:**
88 x 88mm (1-2 gang)
88 x 148mm (3-4 gang)
- **Technical notes:**
All dimmers not suitable with CFL lighting.

2 gang 2 way 250W/VA mains & low voltage



GU6422CSS

Product code	Description	Pack qty
GU6422CSS	Stainless steel	1
GU6422CPC	Polished chrome	1
GU6422CPW	Painted white	1
GU6422CPN	Pearl nickel	1
GU6422CBN	Black nickel	1
GU6422CPB	Polished brass	1

Mains & low voltage and electronic dimmers not suitable for use with LED lamps.

Mains & low voltage dimmers - leading edge control.

LED dimmers - trailing edge control.

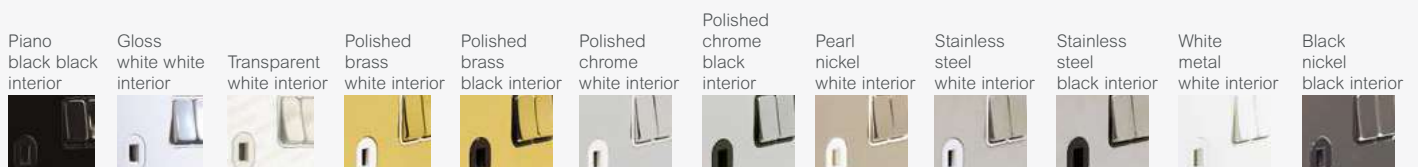

Dimmer switches continued

3 gang 2 way 250W/VA mains & low voltage



GU6432CSS

Product code	Description	Pack qty
GU6432CSS	Stainless steel	1
GU6432CPC	Polished chrome	1
GU6432CPW	Painted white	1
GU6432CPN	Pearl nickel	1
GU6432CBN	Black nickel	1
GU6432CPB	Polished brass	1

4 gang 2 way 250W/VA mains & low voltage

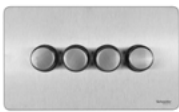

GU6442CSS

Product code	Description	Pack qty
GU6442CSS	Stainless steel	1
GU6442CPC	Polished chrome	1
GU6442CPW	Painted white	1
GU6442CPN	Pearl nickel	1
GU6442CBN	Black nickel	1
GU6442CPB	Polished brass	1

1 gang 2 way 100W/VA LED



GU6412LSS

Product code	Description	Pack qty
GU6412LSS	Stainless steel	1
GU6412LPC	Polished chrome	1
GU6412LPW	Painted white	1
GU6412LPN	Pearl nickel	1
GU6412LBN	Black nickel	1
GU6412LPB	Polished brass	1

2 gang 2 way 100W/VA LED



GU6422LSS

Product code	Description	Pack qty
GU6422LSS	Stainless steel	1
GU6422LPC	Polished chrome	1
GU6422LPW	Painted white	1
GU6422LPN	Pearl nickel	1
GU6422LBN	Black nickel	1
GU6422LPB	Polished brass	1

3 gang 2 way 75W/VA LED



GU6432LSS

Product code	Description	Pack qty
GU6432LSS	Stainless steel	1
GU6432LPC	Polished chrome	1
GU6432LPW	Painted white	1
GU6432LPN	Pearl nickel	1
GU6432LBN	Black nickel	1
GU6432LPB	Polished brass	1

- **Standard of compliance:**
BS EN 669-2-1
- **Mounting box:**
25mm deep (1-2 gang)
35mm deep (3-4 gang)
- **Fixing screws:**
M3.5 x 25mm and
30mm
- **Plate dimensions:**
88 x 88mm (1-2 gang)
88 x 148mm (3-4 gang)
- **Technical notes:**
All dimmers not suitable
with CFL lighting.

Mains & low voltage and
electronic dimmers not
suitable for use with LED
lamps.

Mains & low voltage
dimmers - leading edge
control.

LED dimmers - trailing
edge control.
- **Note:**
Retractive switches are
required for Multi-Way
Operation when using
LED dimmers

Dimmer switches continued

4 gang 2 way 75W/VA LED

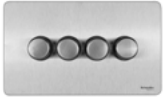

GU6442LSS

Product code	Description	Pack qty
GU6442LSS	Stainless steel	1
GU6442LPC	Polished chrome	1
GU6442LPW	Painted white	1
GU6442LPN	Pearl nickel	1
GU6442LBN	Black nickel	1
GU6442LPB	Polished brass with black interior	1

- **Standard of compliance:** 60669-2-1
- **Mounting box:** Minimum 25mm
- **Fixing screws:** M3.5 x 25mm and 30mm
- **Plate dimensions:** 88 x 88mm (1-2 gang)
- **Technical notes:** IR remote unit requires remote control.
- All dimmers can be installed on 2 way and multiway circuits.
- For 2 way operating remote, switch must be changed for retractive switch.
- Electronic dimmers not suitable for use with CFL and LED lamps of any type.

1 gang 2 way 300W/VA electronic



GU6412EBSS

Product code	Description	Pack qty
GU6412E*SS	Stainless steel	1
GU6412E*PC	Polished chrome	1
GU6412EWPW	Painted white with white interior	1
GU6412EWPN	Pearl nickel with white interior	1
GU6412EBBN	Black nickel with black interior	1
GU6412EBPB	Polished brass with black interior	1

2 gang 2 way 200W/VA electronic



GU6422EBSS

Product code	Description	Pack qty
GU6422E*SS	Stainless steel	1
GU6422EBPC	Polished chrome with black interior	1
GU6422EWPW	Painted white with white interior	1
GU6422EWPN	Pearl nickel with white interior	1
GU6422EBBN	Black nickel with black interior	1
GU6422EBPB	Polished brass with black interior	1

1 gang 2 way 300W/VA IR electronic



GU6412RBSS

Product code	Description	Pack qty
GU6412R*SS	Stainless steel	1
GU6412R*PC	Polished chrome	1
GU6412RWPW	Painted white with white interior	1
GU6412RWPN	Pearl nickel with white interior	1
GU6412RBBN	Black nickel with black interior	1
GU6412RBPB	Polished brass with black interior	1
GU6000RC1R	1 channel IR remote control	1

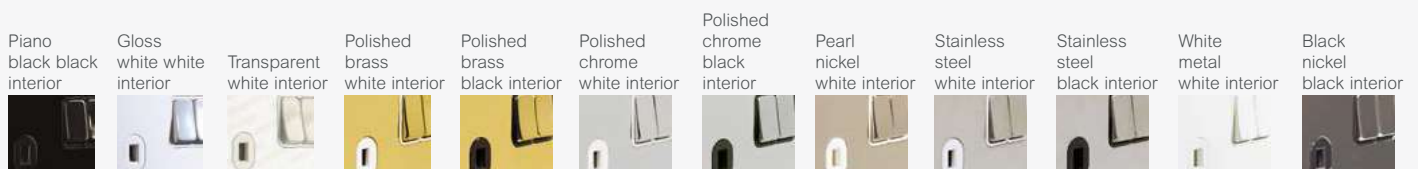

Control switches

20AX double-pole 1 gang



GU2410BSS

Product code	Description	Pack qty
GU2410*SS	Stainless steel	1
GU2410*PC	Polished chrome	1
GU2410WPW	Painted white with white interior	1
GU2410WPN	Pearl nickel with white interior	1
GU2410BBN	Black nickel with black interior	1
GU2410BPB	Polished brass with black interior	1
GU2410CLR	Transparent with white interior	1

- **Standard of compliance:** BS EN 60669-1
- **Mounting box:** 35mm deep
- **Fixing screws:** M3.5 x 25mm and 30mm
- **Plate dimensions:** 88 x 88mm

20AX double-pole 1 gang with neon



GU2411BSS

Product code	Description	Pack qty
GU2411*SS	Stainless steel	1
GU2411*PC	Polished chrome	1
GU2411WPW	Painted white with white interior	1
GU2411WPN	Pearl nickel with white interior	1
GU2411BBN	Black nickel with black interior	1
GU2411BPB	Polished brass with black interior	1
GU2411BBK	Piano black with black interior	1
GU2411WWH	Gloss white with white interior	1

20AX double-pole 1 gang with flex outlet



GU2413BSS

Product code	Description	Pack qty
GU2413*SS	Stainless steel	1
GU2413*PC	Polished chrome	1
GU2413WPW	Painted white with white interior	1
GU2413WPN	Pearl nickel with white interior	1
GU2413BBN	Black nickel with black interior	1
GU2413BPB	Polished brass with black interior	1

20AX double-pole 1 gang with neon & flex outlet



GU2414BSS

Product code	Description	Pack qty
GU2414*SS	Stainless steel	1
GU2414*PC	Polished chrome	1
GU2414WPW	Painted white with white interior	1
GU2414WPN	Pearl nickel with white interior	1
GU2414BBN	Black nickel with black interior	1
GU2414BPB	Polished brass with black interior	1

- **Standard of compliance:** BS EN 60669-1 (switches)
- **Mounting box:** 35mm deep
- **Fixing screws:** M3.5 x 25mm and 30mm
- **Plate dimensions:** 88 x 88mm

Control switches continued

20AX double-pole 1 gang with neon & flex outlet printed water heater



GU2414WHBSS

Product code	Description	Pack qty
GU2414WH*SS	Stainless steel	1
GU2414WH*PC	Polished chrome	1
GU2414WHWPW	Painted white with white interior	1
GU2414WHBBN	Black nickel with black interior	1
GU2414WHBPB	Polished brass with black interior	1

32A double-pole 1 gang with neon



GU4431BSS

Product code	Description	Pack qty
GU4431*SS	Stainless steel	1
GU4431*PC	Polished chrome	1
GU4431WPW	Painted white with white interior	1
GU4431WPN	Pearl nickel with white interior	1
GU4431BBN	Black nickel with black interior	1
GU4431BPB	Polished brass with black interior	1

Fused connection units

13A unswitched



GU5400BSS

Product code	Description	Pack qty
GU5400*SS	Stainless steel	1
GU5400*PC	Polished chrome	1
GU5400WPW	Painted white with white interior	1
GU5400WPN	Pearl nickel with white interior	1
GU5400BBN	Black nickel with black interior	1
GU5400BPB	Polished brass with black interior	1

- **Standard of compliance:** BS 1363
- **Mounting box:** 25mm deep (unswitched)
- **Fixing screws:** M3.5 x 25mm and 30mm
- **Plate dimensions:** 88 x 88mm

13A unswitched with flex outlet



GU5403BSS

Product code	Description	Pack qty
GU5403*SS	Stainless steel	1
GU5403*PC	Polished chrome	1
GU5403WPW	Painted white with white interior	1
GU5403WPN	Pearl nickel with white interior	1
GU5403BBN	Black nickel with black interior	1
GU5403BPB	Polished brass with black interior	1

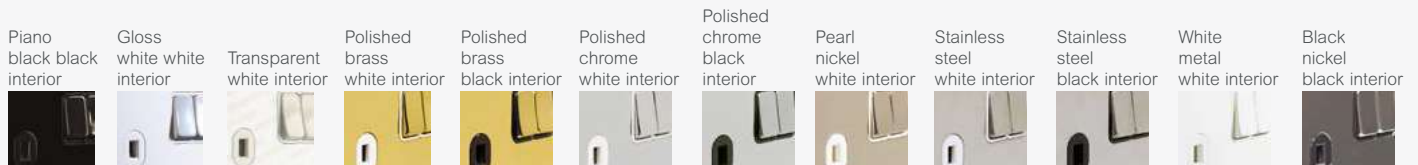

Fused connection units continued

13A double-pole switched



GU5410BSS

Product code	Description	Pack qty
GU5410*SS	Stainless steel	1
GU5410*PC	Polished chrome	1
GU5410WPW	Painted white with white interior	1
GU5410WPN	Pearl nickel with white interior	1
GU5410BBN	Black nickel with black interior	1
GU5410BPB	Polished brass with black interior	1
GU5410CLR	Transparent with white interior	1

- **Standard of compliance:**
BS 1363
- **Mounting box:**
35mm deep (switched)
- **Fixing screws:**
M3.5 x 25mm and 30mm
- **Plate dimensions:**
88 x 88mm

13A double-pole switched with neon



GU5411BSS

Product code	Description	Pack qty
GU5411*SS	Stainless steel	1
GU5411*PC	Polished chrome	1
GU5411WPW	Painted white with white interior	1
GU5411WPN	Pearl nickel with white interior	1
GU5411BBN	Black nickel with black interior	1
GU5411BPB	Polished brass with black interior	1
GU5411BBK	Piano black with black interior	1
GU5411WWH	Gloss white with white interior	1

13A double-pole switched with flex outlet



GU5413BSS

Product code	Description	Pack qty
GU5413*SS	Stainless steel	1
GU5413*PC	Polished chrome	1
GU5413WPW	Painted white with white interior	1
GU5413WPN	Pearl nickel with white interior	1
GU5413BBN	Black nickel with black interior	1
GU5413BPB	Polished brass with black interior	1

13A double-pole switched with neon and flex outlet



GU5414BSS

Product code	Description	Pack qty
GU5414*SS	Stainless steel	1
GU5414*PC	Polished chrome	1
GU5414WPW	Painted white with white interior	1
GU5414WPN	Pearl nickel with white interior	1
GU5414BBN	Black nickel with black interior	1
GU5414BPB	Polished brass with black interior	1

High current switches

50A 2 gang double-pole switches



GU4421BSS

Product code	Description	Pack qty
GU4421*SS	Stainless steel	1
GU4421*PC	Polished chrome	1
GU4421WPW	Painted white with white interior	1
GU4421WPN	Pearl nickel with white interior	1
GU4421BBN	Black nickel with black interior	1
GU4421*PB	Polished brass	1

- **Standard of compliance:** BS EN 60669-1
- **Mounting box:** 47mm deep
- **Fixing screws:** M3.5 x 25mm and 30mm
- **Plate dimensions:** 148 x 88mm

45A double-pole cooker control unit with 13A switched socket & neons



GU4401BSS

Product code	Description	Pack qty
GU4401*SS	Stainless steel	1
GU4401*PC	Polished chrome	1
GU4401WPW	Painted white with white interior	1
GU4401WPN	Pearl nickel with white interior	1
GU4401BBN	Black nickel with black interior	1
GU4401BPB	Polished Brass with black interior	1
GU4401BBK	Piano black with black interior	1
GU4401WWH	Gloss white with white interior	1

- **Standard of compliance:** BS 4177
- **Mounting box:** 47mm deep
- **Fixing screws:** M3.5 x 25mm and 30mm
- **Plate dimensions:** 88 x 148mm

Shaver socket

115/230V dual voltage



GU7490BSS

Product code	Description	Pack qty
GU7490*SS	Stainless steel	1
GU7490*PC	Polished chrome	1
GU7490WPW	Painted white with white interior	1
GU7490WPN	Pearl nickel with white interior	1
GU7490BBN	Black nickel with black interior	1
GU7490BPB	Polished Brass with black interior	1
GU7490BBK	Piano black with black interior	1
GU7490WWH	Gloss white with white interior	1

- **Standard of compliance:** BS EN 61558-2-5
- **Mounting box:** 47mm deep
- **Fixing screws:** M3.5 x 25mm and 30mm
- **Plate dimensions:** 148 x 88mm
- **Technical notes:** Unique design allows perfect fit to 47mm box.

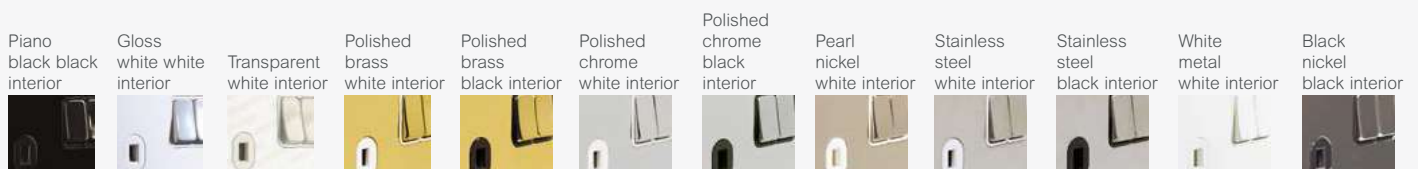

Telephone & Data Outlets

Single RJ11



GU7451BSS

Product code	Description	Pack qty
GU7451*SS	Stainless steel	1
GU7451*PC	Polished chrome	1
GU7451WPW	Painted white with white interior	1
GU7451WPN	Pearl nickel with white interior	1
GU7451BBN	Black nickel with black interior	1
GU7451BPB	Polished Brass with black interior	1

- **Standard of compliance:**
BS EN 41003
- **Mounting box:**
Minimum 25mm deep
- **Fixing screws:**
M3.5 x 25mm and 30mm
- **Plate dimensions:**
88 x 88mm
- **Technical notes:**
Refer to Euro plates & modules section for combined telephone & data solutions.

Master BT telephone



GU7461BSS

Product code	Description	Pack qty
GU7461*SS	Stainless steel	1
GU7461*PC	Polished chrome	1
GU7461WPW	Painted white with white interior	1
GU7461WPN	Pearl nickel with white interior	1
GU7461BBN	Black nickel with black interior	1
GU7462BPB	Polished Brass with black interior	1
GU7461WWH	Gloss white with white interior	1

Secondary BT telephone



GU7462BSS

Product code	Description	Pack qty
GU7462*SS	Stainless steel	1
GU7462*PC	Polished chrome	1
GU7462WPW	Painted white with white interior	1
GU7462WPN	Pearl nickel with white interior	1
GU7462BBN	Black nickel with black interior	1
GU7462BPB	Polished Brass with black interior	1
GU7462WWH	Gloss white with white interior	1

RJ45 CAT5e



GU7471BSS

Product code	Description	Pack qty
GU7471*SS	Stainless steel	1
GU7471*PC	Polished chrome	1
GU7471WPW	Painted white with white interior	1
GU7471WPN	Pearl nickel with white interior	1
GU7471BBN	Black nickel with black interior	1
GU7471BPB	Polished Brass with black interior	1
GU7471BBK	Piano black with black interior	1
GU7471WWH	Gloss white with white interior	1

TV outlets

Single TV/FM



GU7410BSS

Product code	Description	Pack qty
GU7410*SS	Stainless steel	1
GU7410*PC	Polished chrome	1
GU7410WPW	Painted white with white interior	1
GU7410WP	Pearl nickel with white interior	1
GU7410BBN	Black nickel with black interior	1
GU7410BPB	Polished brass with black interior	1

- **Standard of compliance:** BS 3041 (where applicable)
- **Mounting box:** 25mm deep
- **Fixing screws:** M3.5 x 25mm and 30mm
- **Plate dimensions:** 88 x 88mm
- **Technical notes:** Products are direct connection and are not suitable for common connection

Twin TV/FM



GU7420BSS

Product code	Description	Pack qty
GU7420*SS	Stainless steel	1
GU7420*PC	Polished chrome	1
GU7420WPW	Painted white with white interior	1
GU7420WPN	Pearl nickel with white interior	1
GU7420BBN	Black nickel with black interior	1

Single SAT



GU7430BSS

Product code	Description	Pack qty
GU7430*SS	Stainless steel	1
GU7430*PC	Polished chrome	1
GU7430WPW	Painted white with white interior	1
GU7430WPN	Pearl nickel with white interior	1
GU7430BBN	Black nickel with black interior	1
GU7430BPB	Polished brass with black interior	1

Euro modular plates & modules

1 gang euro plate, 1 module 25 x 50mm



GU8450SS

Product code	Description	Pack qty
GU8450SS	Stainless steel	1
GU8450PC	Polished chrome	1
GU8450PW	Painted white	1
GU8450PN	Pearl nickel	1
GU8450BN	Black nickel	1
GU8450PB	Polished brass	1

- **Mounting box:** Refer to module for appropriate mounting box depth
- **Plate dimensions:** 88 x 88mm (1 gang)
- **Technical notes:** Mounting grid supplied with euro plate.

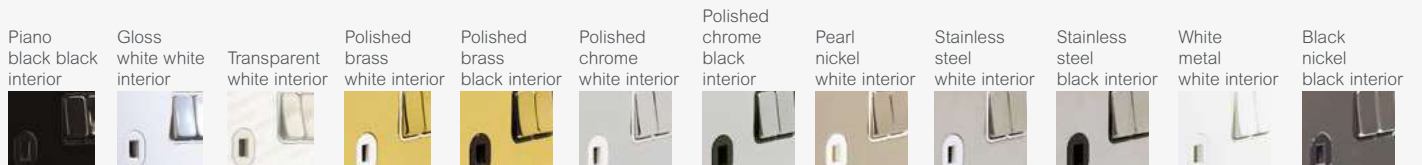

Euro modular plates & modules continued

1 gang euro plate, 2 module 50 x 50mm



GU8460SS

Product code	Description	Pack qty
GU8460SS	Stainless steel	1
GU8460PC	Polished chrome	1
GU8460PW	Painted white	1
GU8460PN	Pearl nickel	1
GU8460BN	Black nickel	1
GU8460PB	Polished brass	1

2 gang euro plate, 4 module 100 x 50mm



GU8480SS

Product code	Description	Pack qty
GU8480SS	Stainless steel	1
GU8480PC	Polished chrome	1
GU8480PW	Painted white	1
GU8480PN	Pearl nickel	1
GU8480BN	Black nickel	1
GU8480PB	Polished brass	1

25 x 50mm euro modules



GUE7073B



GUE7072W



GUE7061B

Product code	Description	Pack qty
GUE7011*	Single IEC coax (female)	1
GUE7012*	25 x 50mm euro modules IEC coax (male)	1
GUE7030*	Single F type sat	1
GUE7061*	BT master telephone	1
GUE7062*K	BT secondary telephone	1
GUE7071*	RJ45 CAT5e (not screened)	1
GUE7072*	RJ45 CAT6 (not screened)	1
GUE7073*	Single USB charger 1A 5Vdc	1
GUE7051*	RJ11 modem	1
GUE7075*	VGA	1
GUE7091*	LexCom Performance outlet	8
GUE7000*	2 x Phono socket	1
GUE7001*	2 x Loudspeaker socket	1
GUE8010*	Blank module	5

50 x 50mm euro modules



GUE7020B



GUE7081W



GUE7010B

Product code	Description	Pack qty
GUE7010*	TV/FM diplexer	1
GUE7040*	TV/Sat diplexer	1
GUE7074*	Twin USB charger 2 x 1A 5Vdc	1
GUE7081*	TV/FM/Sat triplexer	1
GUE7082*	TV/FM/Sat1/Sat2 quadplexer	1
GUE7020*	HDMI	1
GGBLGUE7078*	American power socket**	1
GUE7076*	Brush outlet**	1
GUE7077*	5A round pin socket**	1
GGBGUE7079*	European socket**	1

- **Mounting box:** Refer to module for appropriate mounting box depth
- **Plate dimensions:** 88 x 88mm (1 gang)
88 x 148mm (2 gang)
- **Technical notes:** Mounting grid supplied with euro plate.
- Euro modules plates compatible with Schneider Electric euro modules.
- **Notes:** modules from other suppliers may not be compatible, it is advised to check suitability.

- **Mounting box:** 25mm deep (25 x 50mm modules)
- **Euro module dimensions:** 25 x 50mm (single)

- **Mounting box:** 35mm deep (50 x 50mm modules)
- **Euro module dimensions:** 50 x 50mm (double)
- MTO products for projects only, leadtime to be confirmed at time of ordering
- ****MTO products** for projects only, leadtime to be confirmed at time of ordering

Blank plates & accessories

1 gang



GU8410SS

Product code	Description	Pack qty
GU8410SS	Stainless steel	1
GU8410PC	Polished chrome	1
GU8410PW	Painted white	1
GU8410PN	Pearl nickel	1
GU8410BN	Black nickel	1
GU8410PB	Polished brass	1

- **Standard of compliance:** BS 5733
- **Fixing screws:** M3.5 x 25mm and 30mm
- **Plate dimensions:** 88 x 88mm (1 gang)
88 x 148mm (2 gang)

2 gang



GU8420SS

Product code	Description	Pack qty
GU8420SS	Stainless steel	1
GU8420PC	Polished chrome	1
GU8420PW	Painted white	1
GU8420PN	Pearl nickel	1
GU8420BN	Black nickel	1
GU8420PB	Polished brass	1
3746130	M3.5 x 25mm raised head machine screws	100
USCREW50SS	M3.5 x 50mm screws	100

Grid plates

1 gang 88 x 88mm



GUGS01GSS

Product code	Description	Pack qty
GUGS01GSS	Stainless steel	1
GUGS01GMS	Mirror steel	1
GUGS01GPW	Painted white	1
GUGS01GPN	Pearl nickel	1
GUGS01GBN	Black nickel	1
GUGS01GPB	Polished brass	1
GBG01	76 x 76 x 42mm back box	1

- **Mounting box:** 42mm deep
- **Technical notes:** All grid plates are supplied with the appropriate number of mounting frames.

Mirror steel used for polished chrome grid plates & modules.

2 gang 88 x 88mm



GUGS02GSS

Product code	Description	Pack qty
GUGS02GSS	Stainless steel	1
GUGS02GMS	Mirror steel	1
GUGS02GPW	Painted white	1
GUGS02GPN	Pearl nickel	1
GUGS02GBN	Black nickel	1
GUGS02GPB	Polished brass	1
GBG01	76 x 76 x 42mm back box	1

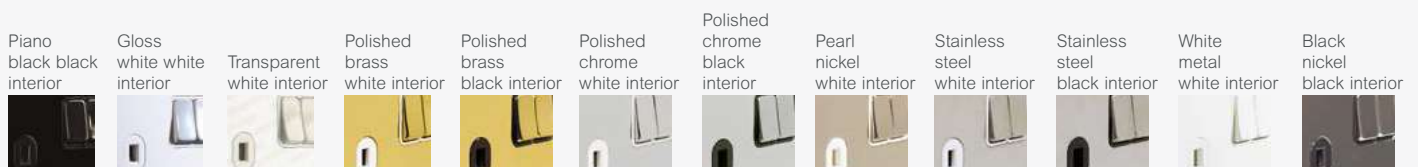

Grid plates continued

3 gang 88 x 148mm



GUGS03GSS

Product code	Description	Pack qty
GUGS03GSS	Stainless steel	1
GUGS03GMS	Mirror steel	1
GUGS03GPW	Painted white	1
GUGS03GPN	Pearl nickel	1
GUGS03GBN	Black nickel	1
GUGS03GPB	Polished brass	1
GBG02	136 x 76 x 42mm back box	1

- **Mounting box:**
42mm deep
- **Technical notes:**
All grid plates are supplied with the appropriate number of mounting frames.
- **Fixing Centres -**
1 Gang = 60.3mm
2 Gang = 120.6mm

Mirror steel used for polished chrome grid plates & modules.

4 gang 88 x 148mm



GUGS04GSS

Product code	Description	Pack qty
GUGS04GSS	Stainless steel	1
GUGS04GMS	Mirror steel	1
GUGS04GPW	Painted white	1
GUGS04GPN	Pearl nickel	1
GUGS04GBN	Black nickel	1
GUGS04GPB	Polished brass	1
GBG02	136 x 76 x 42mm back box	1

6 gang 156 x 156mm



GUGS06SS

Product code	Description	Pack qty
GUGS06GSS	Stainless steel	1
GUGS06GMS	Mirror steel	1
GUGS06GPW	Painted white	1
GUGS06GPN	Pearl nickel	1
GUGS06GBN	Black nickel	1
GUGS06GPB	Polished brass	1
GBG03	136 x 136 x 42mm back box	1

8 gang 156 x 156mm



GUGS08GSS

Product code	Description	Pack qty
GUGS08GSS	Stainless steel	1
GUGS08GMS	Mirror steel	1
GUGS08GPW	Painted white	1
GUGS08GPN	Pearl nickel	1
GUGS08GBN	Black nickel	1
GUGS08GPB	Polished brass	1
GBG03	136 x 136 x 42mm back box	1

Grid plates continued

9 gang 216 x 156mm

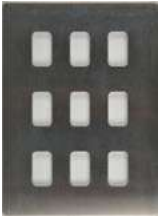

GUGS09GSS

Product code	Description	Pack qty
GUGS09GSS	Stainless steel	1
GUGS09GMS	Mirror steel	1
GUGS09GPW	Painted white	1
GUGS09GPN	Pearl nickel	1
GUGS09GBN	Black nickel	1
GUGS09GPB	Polished brass	1
GBG04F	193 x 133 x 42mm back box	1

- **Mounting box:**
42mm deep
 - **Technical notes:**
All grid plates are supplied with the appropriate number of mounting frames.
- Mirror steel used for polished chrome grid plates & modules.

12 gang 216 x 156mm

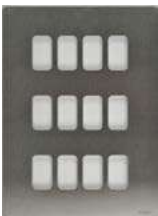

GUGS12GSS

Product code	Description	Pack qty
GUGS12GSS	Stainless steel	1
GUGS12GMS	Mirror steel	1
GUGS12GPW	Painted white	1
GUGS12GPN	Pearl nickel	1
GUGS12GBN	Black nickel	1
GUGS12GPB	Polished brass	1
GBG04F	193 x 133 x 42mm back box	1

18 gang 398 x 156mm



GUGS18GSS

Product code	Description	Pack qty
GUGS18GSS	Stainless steel	1
GUGS18GMS	Mirror steel	1
GUGS18GPW	Painted white	1
GUGS18GPN	Pearl nickel	1
GUGS18GBN	Black nickel	1
GUGS18GPB	Polished brass	1
GBG06F	374 x 133 x 42mm back box	1

24 gang 398 x 156mm



GUGS24GSS

Product code	Description	Pack qty
GUGS24GSS	Stainless steel	1
GUGS24GMS	Mirror steel	1
GUGS24GPW	Painted white	1
GUGS24GPN	Pearl nickel	1
GUGS24GBN	Black nickel	1
GUGS24GPB	Polished brass	1
GBG06F	374 x 133 x 42mm back box	1

Customisable switch grid modules

10AX metal switch module components (white or black surrounds)



GUG102MB GUG101MW

Product code	Description	Pack qty
GUG101M*	10AX 1 way SP	1
GUG102M*	10AX 2 way SP	1
GUG101M*	10AX intermediate SP	1

20AX metal switch module components (white or black surrounds)



GUG2020MB GUG20DPMW

Product code	Description	Pack qty
GUG201M*	20AX 1 way SP	1
GUG2020M*	20AX 2 way and centre off	1
GUG202M*	20AX 2 way SP	1
GUG20DPM*	20AX DP	1

- **Standard of compliance:** BS EN 60669-1
- **Mounting box:** 42mm deep
- **Technical notes:** 10AX & 20AX metal switch module components available in black or white.
- Clear terminal marking printed onto grey switch module component back mouldings ensures easy identification.
- Pre-printed rocker caps
- Easy assembly

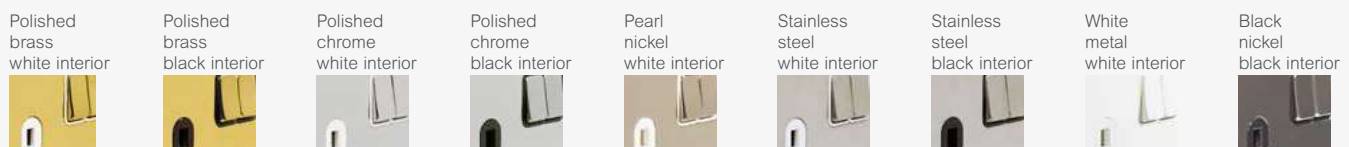
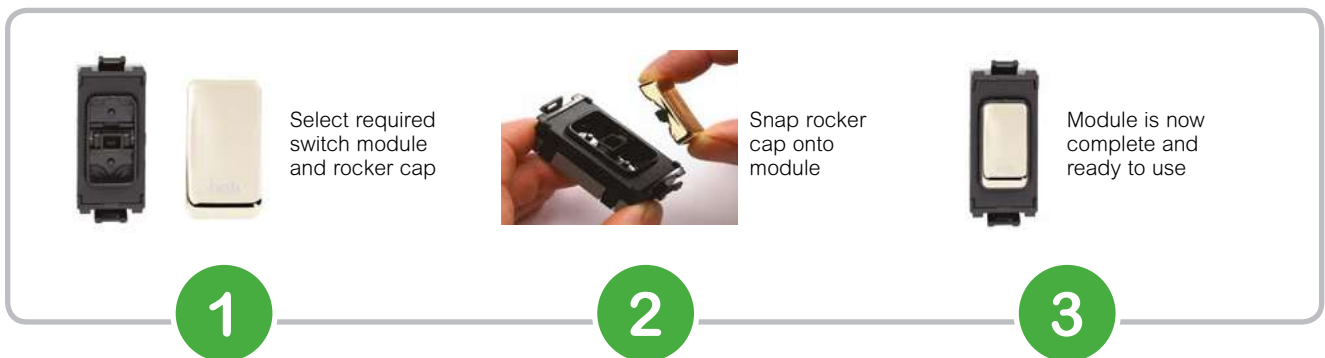

Plain and printed rocker caps for component modules



	Stainless Steel	Mirror Steel	Polished Brass	Pearl Nickel	Painted White	Black Nickel	Painted Black
Plain rocker cap	GUGRSS	GUGRMS	GUGRPB	GUGRPN	GUGRPW	GUGRBN	GUGRBLK
Rocker cap printed boiler	GUGRBOSS	GUGRBOMS	GUGRBOPB	GUGRBOPN	GUGRBOPW	GUGRBOBN	GUGRBOBLK
Rocker cap printed cooker hood	GUGRCHSS	GUGRCHMS	GUGRCHPB	GUGRCHPN	GUGRCHPW	GUGRCHBN	GUGRCHBLK
Rocker cap printed dish washer	GUGRDWSS	GUGRDWMS	GUGRDWPB	GUGRDWPN	GUGRDWPW	GUGRDWBN	GUGRDWBLK
Rocker cap printed extractor fan	GUGREFSS	GUGREFMS	GUGREFPB	GUGREFPN	GUGREFPW	GUGREFBN	GUGREFBLK
Rocker cap printed fridge	GUGRFRSS	GUGRFRMS	GUGRFRPB	GUGRFRPN	GUGRFRPW	GUGRFRBN	GUGRFRBLK
Rocker cap printed fan	GUGRFASS	GUGRFAMS	GUGRFAPB	GUGRFAPN	GUGRFAPW	GUGRFABN	GUGRFABLK
Rocker cap printed freezer	GUGRFZSS	GUGRFZMS	GUGRFZPB	GUGRFZPN	GUGRFZPW	GUGRFZBN	GUGRFZBLK
Rocker cap printed fridge/freezer	GUGRFRFZSS	GUGRFRFZMS	GUGRFRFZPB	GUGRFRFZPN	GUGRFRFZPW	GUGRFRFZBN	GUGRFRFZBLK
Rocker cap printed hob	GUGRHOSS	GUGRHOMS	GUGRHOPB	GUGRHOPN	GUGRHOPW	GUGRHOBN	GUGRHOBLK
Rocker cap printed heater	GUGRHESS	GUGRHEMS	GUGRHEPB	GUGRHEPN	GUGRHEPW	GUGRHEBN	GUGRHEBLK
Rocker cap printed microwave	GUGRMWSS	GUGRMWMS	GUGRMWPB	GUGRMWPN	GUGRMWPW	GUGRMWBN	GUGRMWBLK
Rocker cap printed oven	GUGROVSS	GUGROVMS	GUGROVPB	GUGROVPN	GUGROVPW	GUGROVBN	GUGROVBLK
Rocker cap printed tumble dryer	GUGRTDSS	GUGRTDMS	GUGRTDPB	GUGRTDPN	GUGRTDPW	GUGRTDBN	GUGRTDBLK
Rocker cap printed washer dryer	GUGRWDYSS	GUGRWDYMS	GUGRWDYPB	GUGRWDYPN	GUGRWDYPW	GUGRWDYBN	GUGRWDYBLK
Rocker cap printed waste disposal	GUGRWDSS	GUGRWDMS	GUGRWDPB	GUGRWDPN	GUGRWDPW	GUGRWDDBN	GUGRWDDBLK
Rocker cap printed washing machine	GUGRWMSS	GUGRWMMS	GUGRWMPB	GUGRWMPN	GUGRWMPW	GUGRWMBN	GUGRWMBLK

Retractive & toggle switch grid modules

6A 2 way retractive and centre off



GUG202OCBSS

Product code	Description	Pack qty
GUG202OC*SS	Stainless steel	1
GUG202OC*MS	Mirror steel	1
GUG202OCWPW	Painted white with white interior	1
GUG202OCWPN	Pearl nickel with white interior	1
GUG202OCBBN	Black nickel with black interior	1
GUG202OC*PB	Polished brass	1

- **Standard of compliance:** BS EN 60669-1
- **Mounting box:** 42mm deep
- **Technical notes:** Mirror steel used for polished chrome grid plates & modules.

Retractive & toggle switch grid modules continued

10A 2 way retractive single-pole



GUG102RBSS

Product code	Description	Pack qty
GUG102R*SS	Stainless steel	1
GUG102R*MS	Mirror steel	1
GUG102RWPW	Painted white with white interior	1
GUG102RWPN	Pearl nickel with white interior	1
GUG102RBBN	Black nickel with black interior	1
GUG102R*PB	Polished brass	1

10AX way single-pole toggle



GUG102TBSS

Product code	Description	Pack qty
GUG102T*SS	Stainless steel	1
GUG102T*MS	Mirror steel	1
GUG102TWPW	Painted white with white interior	1
GUG102TWPN	Pearl nickel with white interior	1
GUG102TBBN	Black nickel with black interior	1
GUG102T*PB	Polished brass	1

10AX intermediate toggle



GUG101TBSS

Product code	Description	Pack qty
GUG101T*SS	Stainless steel	1
GUG101T*MS	Mirror steel	1
GUG101TWPW	Painted white with white interior	1
GUG101TWPN	Pearl nickel with white interior	1
GUG101TBBN	Black nickel with black interior	1
GUG101T*PB	Polished brass	1

Polished brass white interior



Polished brass black interior



Polished chrome white interior



Polished chrome black interior



Pearl nickel white interior



Stainless steel white interior



Stainless steel black interior

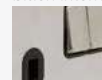

White metal white interior



Black nickel black interior



Key switch grid modules

20AX 1 way key operated double-pole



GUG20DPKBSS

Product code	Description	Pack qty
GUG20DPK*SS	Stainless steel	1
GUG20DPK*MS	Mirror steel	1
GUG20DPKW PW	Painted white with white interior	1
GUG20DPKW PN	Pearl nickel with white interior	1
GUG20DPKBBN	Black nickel with black interior	1
GUG20DPK*PB	Polished brass	1

- **Standard of compliance:** BS EN 60669-1
- **Mounting box:** 42mm deep
- **Technical notes:** Mirror steel used for polished chrome grid plates & modules.

20AX 2 way key operated



GUG202KBSS

Product code	Description	Pack qty
GUG202K*SS	Stainless steel	1
GUG202K*MS	Mirror steel	1
GUG202KW PW	Painted white with white interior	1
GUG202KW PN	Pearl nickel with white interior	1
GUG202KBBN	Black nickel with black interior	1
GUG202K*PB	Polished brass	1

20AX 2 way key operated printed red TEST EMG LTG



GUG202KELBSS

Product code	Description	Pack qty
GUG202KEL*SS	Stainless steel	1
GUG202KEL*MS	Mirror steel	1
GUG202KELW PW	Painted white with white interior	1
GUG202KELW PN	Pearl nickel with white interior	1
GUG202KELBBN	Black nickel with black interior	1
GUG202KEL*PB	Polished brass	1

Telephone grid modules

BT master telephone



GUGTELMBSS

Product code	Description	Pack qty
GUGTELM*SS	Stainless steel	1
GUGTELM*MS	Mirror steel	1
GUGTELMWPW	Painted white with white interior	1
GUGTELMWPN	Pearl nickel with white interior	1
GUGTELMBBN	Black nickel with black interior	1
GUGTELM*PB	Polished brass	1

- **Standard of compliance:** BS EN 3041 (where applicable)
- **Mounting box:** 42mm deep
- **Technical notes:** Mirror steel used for polished chrome grid plates & modules.

BT secondary telephone



GUGTELSBSS

Product code	Description	Pack qty
GUGTELS*SS	Stainless steel	1
GUGTELS*MS	Mirror steel	1
GUGTELSWPW	Painted white with white interior	1
GUGTELSWPN	Pearl nickel with white interior	1
GUGTELSBBN	Black nickel with black interior	1
GUGTELS*PB	Polished brass	1

RJ11 telephone



GUGRJ11BSS

Product code	Description	Pack qty
GUGRJ11*SS	Stainless steel	1
GUGRJ11*MS	Mirror steel	1
GUGRJ11WPW	Painted white with white interior	1
GUGRJ11BBN	Black nickel with black interior	1
GUGRJ11*PB	Polished brass	1

Polished brass white interior



Polished brass black interior



Polished chrome white interior



Polished chrome black interior



Pearl nickel white interior



Stainless steel white interior



Stainless steel black interior



White metal white interior



Black nickel black interior



Data & TV grid modules

RJ45 CAT5e



GUGRJ45BSS

Product code	Description	Pack qty
GUGRJ45*SS	Stainless steel	1
GUGRJ45*MS	Mirror steel	1
GUGRJ45WPW	Painted white with white interior	1
GUGRJ45WPN	Pearl nickel with white interior	1
GUGRJ45BBN	Black nickel with black interior	1
GUGRJ45*PB	Polished brass	1

- **Standard of compliance:** BS EN 3041 (where applicable)
- **Mounting box:** 42mm deep
- **Technical notes:** Mirror steel used for polished chrome grid plates & modules.

Direct coaxial TV



GUGCOBSS

Product code	Description	Pack qty
GUGCO*SS	Stainless steel	1
GUGCO*MS	Mirror steel	1
GUGCOWPW	Painted white with white interior	1
GUGCOWPN	Pearl nickel with white interior	1
GUGCOBBN	Black nickel with black interior	1
GUGCO*PB	Polished brass	1

F type satellite



GUGSATBSS

Product code	Description	Pack qty
GUGSAT*SS	Stainless steel	1
GUGSAT*MS	Mirror steel	1
GUGSATWPW	Painted white with white interior	1
GUGSATWPN	Pearl nickel with white interior	1
GUGSATBBN	Black nickel with black interior	1
GUGSAT*PB	Polished brass	1

Electronic dimmer grid modules

300W/VA universal multiway touch dimmer module



GUGEMDIMBSS16

Product code	Description	Pack qty
GUGEMDIM*SS16	Stainless steel	1
GUGEMDIM*MS16	Mirror steel	1
GUGEMDIMWPW16	Painted white with white interior	1
GUGEMDIMWPN16	Pearl nickel with white interior	1
GUGEMDIMBBN16	Black nickel with black interior	1
GUGEMDIMBPB16	Polished brass with black interior	1

- **Mounting box:** 42mm deep
- **Technical notes:** Min load 60W/50VA. Mirror steel used for polished chrome grid plates & modules.

300W/VA universal multiway touch dimmer module with infra red remote option



GUGEMRDIMB16

Product code	Description	Pack qty
GUGEMRDIMW16	White moulded	1
GUGEMRDIMB16	Black moulded	1
GU6000RC1R	1 channel IR remote control	1

- Electronic modules are capable of 2 way or multiway dimming.
- Retractive switch for use with electronic dimmers only.
- Not compatible with moulded grid plates.
- Modules will require derating when used in multi-gang applications.

Electronic dimmer grid modules continued

50mA 2 way & multiway retractive switch module



GUGEMWBSS

Product code	Description	Pack qty
GUGEMW*SS	Stainless steel	1
GUGEMW*MS	Mirror steel	1
GUGEMWWPW	Painted white with white interior	1
GUGEMWWPN	Pearl nickel with white interior	1
GUGEMWBBN	Black nickel with black interior	1

Fuse carrier, flex outlet & blank grid modules

13A fuse carrier



GUG13FCUBSS

Product code	Description	Pack qty
GUG13FCU*SS	Stainless steel	1
GUG13FCU*MS	Mirror steel	1
GUG13FCUWPW	Painted white with white interior	1
GUG13FCUWPN	Pearl nickel with white interior	1
GUG13FCUBBN	Black nickel with black interior	1
GUG13FCU*PB	Polished brass	1

- **Standard of compliance:**
BS 1363 (fuse carrier)
BS 5733
- **Mounting box:**
42mm deep
- **Technical notes:**
Full metal surround on all modules
Modules are completely interchangeable

Mirror steel used for polished chrome grid plates & modules.

Flex outlet up to 10mm ø



GUG16COBSS

Product code	Description	Pack qty
GUG16CO*SS	Stainless steel	1
GUG16CO*MS	Mirror steel	1
GUG16COWPW	Painted white with white interior	1
GUG16COWPN	Pearl nickel with white interior	1
GUG16COBBN	Black nickel with black interior	1
GUG16CO*PB	Polished brass	1

Blank



GUGBBSS

Product code	Description	Pack qty
GUGB*SS	Stainless steel	1
GUGB*MS	Mirror steel	1
GUGBWPW	Painted white with white interior	1
GUGBWPN	Pearl nickel with white interior	1
GUGBBBN	Black nickel with black interior	1
GUGB*PB	Polished brass	1
GUGB*	Moulded plastic (black or white)	1

Polished brass white interior



Polished brass black interior



Polished chrome white interior



Polished chrome black interior



Pearl nickel white interior



Stainless steel white interior



Stainless steel black interior



White metal white interior



Black nickel black interior



Indicator modules

White surround



GUGINDWG



GUGINDWR



GUGINDWO

Product code	Description	Pack qty
GUGINDWG	Green indicator	1
GUGINDWR	Red indicator	1
GUGINDWO	Orange indicator	1

- **Standard of compliance:** BS 5733
- **Technical notes:** 240V

Black surround



GUGINDBG



GUGINDBR



GUGINDBO

Product code	Description	Pack qty
GUGINDBG	Green indicator	1
GUGINDBR	Red indicator	1
GUGINDBO	Orange indicator	1

Flush galvanised steel boxes

16mm deep



SB161

Product code	Description	Pack qty
SB161	1 gang	20

25mm deep

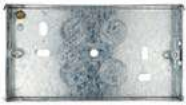

SB252

Product code	Description	Pack qty
SB251	1 gang	10
SB252	2 gang	10

35mm deep



SB351

Product code	Description	Pack qty
SB351	1 gang	10
SB352	2 gang	5

47mm deep



SB472

Product code	Description	Pack qty
SB471	1 gang	10
SB472	2 gang	4

- **Standard of compliance:** BS4662

- **Technical notes:** Supplied with earth terminal and screw.

Supplied with fixed and adjustable lugs.

Fitted with selection of 20mm knockouts in sides and back.

A photograph of two young women sitting in a kitchen, laughing joyfully. The woman on the left is wearing a black and white striped long-sleeved shirt and holding a wine glass with white wine. The woman on the right is wearing a red top and also holding a wine glass with white wine. In the background, there is a stainless steel range hood and a window with green foliage outside. A solid green horizontal band is overlaid across the middle of the image, containing the text.

Ultimate Flat Plate

ULTIMATE Flat Plate

Combining superior engineering with urban style, Ultimate Flat Plate utilises the aesthetics and functions of the Ultimate range, with an ultra slim 1.5mm thick front plate. With complementary finishes numerous aspects to make installation easier, flat plate is a firm favourite of consumers and electrical contractors alike.

Available in a choice of six high quality finishes with black or white interior options – coordinating these accessories has never been easier.

Colour matched screws with eyelets for seamless colour consistency

Choice of 6 finishes & multiple interior options to compliment virtually all décor - traditional or contemporary

1.5mm Plate thickness together with large footprint Provides extra strength and reduces the need for additional decorating

Curved Metal Capped Rockers for a stylish look & easier operation

Flat headed screws ensures flat profile across plate when fitted

Two sets of secured fitting screws supplied to reduce risk of loss during installation. Long and short screws offer flexibility during installation

A pre-fitted, close cell foam gasket aids installation on uneven walls, in addition to providing moisture protection. Foam gasket is pre-fitted to save time.

Colour coded in-line terminals as well as a colour balanced back moulding makes terminals easily identifiable during installation, particularly in lower light levels

Specification Highlights:



13A Floor Sockets offer additional flexibility and easier power accessibility for residential and commercial floor plans



Outboard Sockets provide a practical solution for improved visibility and ease of operation



Control energy access can improve public safety in communal areas with non standard sockets,



A complete range of 2A, 5A, and 15A round pin sockets outlets to support bespoke lighting designs.



Twin earth terminals on 2 gang sockets enable installation in areas requiring high integrity earthing

Socket outlets

13A 1 gang unswitched



GU3250WPC

Product code	Description	Pack qty
GU3250*SS	Stainless steel	1
GU3250*PC	Polished chrome	1
GU3250WPC	Painted white with white interior	1
GU3250WPN	Pearl nickel with white interior	1
GU3250BBN	Black nickel with black interior	1
GU3250BPB	Polished brass with black insert	1

- **Standard of compliance:**
BS 1363 (13A)
- **Mounting box:**
Minimum 25mm deep
- **Fixing screws:**
M3.5 x 25mm and 30mm
- **Plate dimensions:**
88 x 88mm (1 gang)
88 x 148mm (2 gang)
- **Technical notes:**
All 2 gang sockets supplied with twin earth terminals as standard. To aid flush installation, 35mm steel boxes are recommended (BS7671).

13A 2 gang unswitched



GU3260WPC

Product code	Description	Pack qty
GU3260*SS	Stainless steel	1
GU3260*PC	Polished chrome	1
GU3260WPC	Painted white with white interior	1
GU3260WPN	Pearl nickel with white interior	1
GU3260BBN	Black nickel with black interior	1
GU3260BPB	Polished brass with black insert	1

13A 1 gang single-pole switched



GU3210WPC

Product code	Description	Pack qty
GU3210*SS	Stainless steel	1
GU3210*PC	Polished chrome	1
GU3210WPC	Painted white with white interior	1
GU3210WPN	Pearl nickel with white interior	1
GU3210BBN	Black nickel with black interior	1
GU3210BPB	Polished brass with black insert	1

13A 1 gang double-pole switched



GU3210DWPC

Product code	Description	Pack qty
GU3210D*SS	Stainless steel	1
GU3210D*PC	Polished chrome	1
GU3210DWPC	Painted white with white interior	1
GU3210DWPN	Pearl nickel with white interior	1
GU3210DBBN	Black nickel with black interior	1
GU3210DBPB	Polished brass with black insert	1

13A 2 gang single-pole switched



GU3220WPC

Product code	Description	Pack qty
GU3220*SS	Stainless steel	1
GU3220*PC	Polished chrome	1
GU3220WPC	Painted white with white interior	1
GU3220WPN	Pearl nickel with white interior	1
GU3220BBN	Black nickel with black interior	1
GU3220 BPB	Polished brass with black insert	1

Socket outlets continued

13A 2 gang double-pole switched

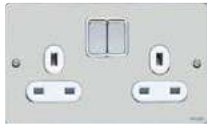

GU3220DWPC

Product code	Description	Pack qty
GU3220D*SS	Stainless steel	1
GU3220D*PC	Polished chrome	1
GU3220DWPW	Painted white with white interior	1
GU3220DWPN	Pearl nickel with white interior	1
GU3220DBBN	Black nickel with black interior	1
GU3220DBPB	Polished brass with black insert	1

- **Standard of compliance:** BS 1363 (13A)
- **Mounting box:** Minimum 25mm deep
- **Fixing screws:** M3.5 x 25mm and 30mm
- **Plate dimensions:** 88 x 88mm (1 gang)
88 x 148mm (2 gang)
- **Technical notes:** All 2 gang sockets supplied with twin earth terminals as standard. To aid flush installation, 35mm steel boxes are recommended (BS7671).
- Floor socket interiors are manufactured from high impact thermoplastic for strength.

13A 2 gang double-pole switched with clean earth & outboard rockers



GU3231WPC

Product code	Description	Pack qty
GU3231*SS	Stainless steel	1
GU3231*PC	Polished chrome	1
GU3231WPW	Painted white	1
GU3231BBN	Black nickel	1

13A 2 gang double-pole switched with clean earth & outboard rockers



GU3234WPC

Product code	Description	Pack qty
GU3234*SS	Stainless steel	1
GU3234WPC	Polished chrome	1

13A 1 gang unswitched floor socket



GU3251WSS

Product code	Description	Pack qty
GU3251*SS	Stainless steel	1
GU3251*PC	Polished chrome	1
GU3251WPW	Painted white with white interior	1
GU3251WPN	Pearl nickel with white interior	1
GU3251BBN	Black nickel with black interior	1
GU3251BPB	Polished brass with black insert	1

13A 2 gang unswitched floor socket



GU3252WPC

Product code	Description	Pack qty
GU3252*SS	Stainless steel	1
GU3252*PC	Polished chrome	1
GU3252WPW	Painted white with white interior	1
GU3252WPN	Pearl nickel with white interior	1
GU3252BBN	Black nickel with black interior	1
GU3252BPB	Polished brass with black insert	1

Polished brass white interior



Polished brass black interior



Polished chrome white interior



Polished chrome black interior



Pearl nickel white interior



Stainless steel white interior

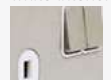

Stainless steel black interior



White metal white interior



Black nickel black interior



Socket outlets continued

2A unswitched round pin



GU3270WPC

Product code	Description	Pack qty
GU3270*SS	Stainless steel	1
GU3270*PC	Polished chrome	1
GU3270*PW	Painted white with white interior	1
GU3270WPN	Pearl nickel with white interior	1
GU3270BBN	Black nickel with black interior	1
GU3270BPB	Polished brass with black insert	1

- **Standard of compliance:** BS 546 (round pin)
- **Mounting box:** Minimum 25mm deep
- **Fixing screws:** M3.5 x 25mm and 30mm
- **Plate dimensions:** 86 x 86mm (1 gang)

5A unswitched round pin



GU3280WPC

Product code	Description	Pack qty
GU3280*SS	Stainless steel	1
GU3280*PC	Polished chrome	1
GU3280*PW	Painted white with white interior	1
GU3280WPN	Pearl nickel with white interior	1
GU3280BBN	Black nickel with black interior	1
GU3280BPB	Polished brass with black insert	1

15A switched round pin



GU3290WPC

Product code	Description	Pack qty
GU3290*SS	Stainless steel	1
GU3290*PC	Polished chrome	1
GU3290*PW	Painted white with white interior	1
GU3290WPN	Pearl nickel with white interior	1
GU3290BBN	Black nickel with black interior	1
GU3290BPB	Polished brass with black interior	1

Media plates

Stacked with 2 x 2 gang double-pole socket outlets & 4 x 2 module euro

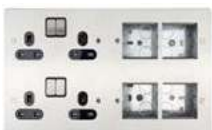

GU32204DMPWPC

Product code	Description	Pack qty
GU32204DMP*SS	Stainless steel	1
GU32204DMP*PC	Polished chrome	1
GU32204DMPWPW	Painted white with white interior	1
GU32204DMPWPN	Pearl nickel with white interior	1
GU32204DMPBBN	Black nickel with black interior	1
GU32204DMPBPB	Polished brass with black insert	1
GGBSB4724M	Stacked back box	1

- **Standard of compliance:** BS 5733 BS 1363-2
- **Mounting box:** 47mm deep
- **Fixing screws:** M3.5 x 25mm and 30mm
- **Plate dimensions:** 296 x 88mm (in-line) 296 x 176mm (stacked)

In-line with 2 gang double-pole socket outlets & 2 x 2 module euro



GU32202DMPWPC

Product code	Description	Pack qty
GU32202DMP*SS	Stainless steel	1
GU32202DMP*PC	Polished chrome	1
GU32202DMPWPW	Painted white with white interior	1
GU32202DMPWPN	Pearl nickel with white interior	1
GU32202DMPBBN	Black nickel with black interior	1
GU32202DMPBPB	Polished brass with black insert	1
GGBSB4722M	In-line back box	1

Plate switches

16AX 1 gang 2 way



GU1212WPC

Product code	Description	Pack qty
GU1212*SS	Stainless steel	1
GU1212*PC	Polished chrome	1
GU1212*PW	Painted white with white interior	1
GU1212WPN	Pearl nickel with white interior	1
GU1212BBN	Black nickel with black interior	1
GU1212BPB	Polished brass with black insert	1

- **Standard of compliance:**
BS EN 60669-1
- **Mounting box:**
16mm deep (1-2 gang)
25mm deep (3-6 gang)
- **Fixing screws:**
M3.5 x 25mm and 30mm
- **Plate dimensions:**
88 x 88mm (1-3 gang),
88 x 148mm (4-6 gang)

16AX 1 gang intermediate



GU1214WPC

Product code	Description	Pack qty
GU1214*SS	Stainless steel	1
GU1214*PC	Polished chrome	1
GU1214*PW	Painted white with white interior	1
GU1214WPN	Pearl nickel with white interior	1
GU1214BBN	Black nickel with black interior	1
GU1214BPB	Polished brass with black insert	1

16A 1 gang 2 way retractive



GU1212RWPC

Product code	Description	Pack qty
GU1212R*SS	Stainless steel	1
GU1212R*PC	Polished chrome	1
GU1212R*PW	Painted white with white interior	1
GU1212RWPN	Pearl nickel with white interior	1
GU1212RBBN	Black nickel with black interior	1
GU1212RBPB	Polished brass with black insert	1

16AX 2 gang 2 way



GU1222WPC

Product code	Description	Pack qty
GU1222*SS	Stainless steel	1
GU1222*PC	Polished chrome	1
GU1222*PW	Painted white with white interior	1
GU1222WPN	Pearl nickel with white interior	1
GU1222BBN	Black nickel with black interior	1
GU1222BPB	Polished brass with black insert	1

16AX 3 gang 2 way



GU1232WPC

Product code	Description	Pack qty
GU1232*SS	Stainless steel	1
GU1232*PC	Polished chrome	1
GU1232*PW	Painted white with white interior	1
GU1232WPN	Pearl nickel with white interior	1
GU1232BBN	Black nickel with black interior	1
GU1232BPB	Polished brass with black insert	1

Polished brass white interior



Polished brass black interior



Polished chrome white interior



Polished chrome black interior



Pearl nickel white interior



Stainless steel white interior



Stainless steel black interior

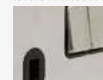

White metal white interior



Black nickel black interior

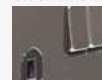

Plate switches continued

16AX 4 gang 2 way



GU1242WPC

Product code	Description	Pack qty
GU1242*SS	Stainless steel	1
GU1242*PC	Polished chrome	1
GU1242*PW	Painted white with white interior	1
GU1242WPN	Pearl nickel with white interior	1
GU1242BBN	Black nickel with black interior	1
GU1242BPB	Polished brass with black insert	1

- **Standard of compliance:**
BS EN 60669-1
BS EN 60947-3
(GU1213***)
- **Mounting box:**
16mm deep (1-2 gang)
25mm deep (3-6 gang)
- **Fixing screws:**
M3.5 x 25mm and
30mm
- **Plate dimensions:**
88 x 88mm (1-3 gang),
88 x 148mm (4-6 gang)

16AX 6 gang 2 way



GU1262WPC

Product code	Description	Pack qty
GU1262*SS	Stainless steel	1
GU1262*PC	Polished chrome	1
GU1262*PW	Painted white with white interior	1
GU1262WPN	Pearl nickel with white interior	1
GU1262BBN	Black nickel with black interior	1
GU1262BPB	Polished brass with black insert	1

10A triple pole isolator



GU1213WPC

Product code	Description	Pack qty
GU1213*SS	Stainless steel	1
GU1213*PC	Polished chrome	1
GU1213*PW	Painted white with white interior	1
GU1213WPN	Pearl nickel with white interior	1
GU1213BBN	Black nickel with black interior	1
GU1213BPB	Polished brass with black insert	1

Toggle switches

16AX 1 gang 2 way



GU1212TPB

Product code	Description	Pack qty
GU1212TSS	Stainless steel	1
GU1212TPC	Polished chrome	1
GU1212TPW	Painted white	1
GU1212TPN	Pearl nickel	1
GU1212TBN	Black nickel	1
GU1212TPB	Polished brass	1

- **Standard of compliance:**
BS EN 60669-1
- **Mounting box:**
16mm deep (1-2 gang)
25mm deep (3-4 gang)
- **Fixing screws:**
M3.5 x 25mm and
30mm
- **Plate dimensions:**
88 x 88mm (1-3 gang)
88 x 148mm (4 gang)

16AX 2 gang 2 way



GU1222TPC

Product code	Description	Pack qty
GU1222TSS	Stainless steel	1
GU1222TPC	Polished chrome	1
GU1222TPW	Painted white	1
GU1222TPN	Pearl nickel	1
GU1222TBN	Black nickel	1
GU1222TPB	Polished brass	1

Toggle switches continued

16AX 3 gang 2 way



GU1232TPC

Product code	Description	Pack qty
GU1232TSS	Stainless steel	1
GU1232TPC	Polished chrome	1
GU1232TPW	Painted white	1
GU1232TPN	Pearl nickel	1
GU1232TBN	Black nickel	1
GU1232TPB	Polished brass	1

- **Standard of compliance:** BS EN 60669-1
- **Mounting box:** 25mm deep (3-4 gang)
- **Fixing screws:** M3.5 x 25mm and 30mm
- **Plate dimensions:** 88 x 88mm (1-3 gang)
88 x 148mm (4 gang)

16AX 4 gang 2 way



GU1242TPB

Product code	Description	Pack qty
GU1242TSS	Stainless steel	1
GU1242TPC	Polished chrome	1
GU1242TPW	Painted white	1
GU1242TPN	Pearl nickel	1
GU1242TBN	Black nickel	1
GU1242TPB	Polished brass	1

Dimmer switches

1 gang 2 way 400W/VA mains & low voltage



GU6212PC

Product code	Description	Pack qty
GU6212CSS	Stainless steel	1
GU6212CPC	Polished chrome	1
GU6212CPW	Painted white	1
GU6212CPN	Pearl nickel	1
GU6212CBN	Black nickel	1
GU6212CPB	Polished brass	1

- **Standard of compliance:** BS EN 60669-2-1
- **Mounting box:** 25mm deep (1-2 gang)
35mm deep (3-4 gang)
- **Fixing screws:** M3.5 x 25mm and 30mm
- **Plate dimensions:** 88 x 88mm (1-2 gang)
88 x 148mm (3-4 gang)

2 gang 2 way 250W/VA mains & low voltage



GU6222CPC

Product code	Description	Pack qty
GU6222CSS	Stainless steel	1
GU6222CPC	Polished chrome	1
GU6222CPW	Painted white	1
GU6222CPN	Pearl nickel	1
GU6222CBN	Black nickel	1
GU6222CPB	Polished brass	1

- **Technical notes:** All dimmers not suitable with CFL lighting.

Mains & low voltage and electronic dimmers not suitable for use with LED lamps.

Mains & low voltage dimmers - leading edge control.

LED dimmers - trailing edge control.

Polished brass white interior



Polished brass black interior



Polished chrome white interior



Polished chrome black interior



Pearl nickel white interior



Stainless steel white interior



Stainless steel black interior



White metal white interior



Black nickel black interior



Dimmer switches continued

3 gang 2 way 250W/VA mains & low voltage



GU6232CPC

Product code	Description	Pack qty
GU6232CSS	Stainless steel	1
GU6232CPC	Polished chrome	1
GU6232CPW	Painted white	1
GU6232CPN	Pearl nickel	1
GU6232CBN	Black nickel	1
GU6232CPB	Polished brass	1

4 gang 2 way 250W/VA mains & low voltage



GU6242CPC

Product code	Description	Pack qty
GU6242CSS	Stainless steel	1
GU6242CPC	Polished chrome	1
GU6242CPW	Painted white	1
GU6242CPN	Pearl nickel	1
GU6242CBN	Black nickel	1
GU6242CPB	Polished brass	1

1 gang 2 way 100W/VA LED



GU6212LPC

Product code	Description	Pack qty
GU6212LSS	Stainless steel	1
GU6212LPC	Polished chrome	1
GU6212LPW	Painted white	1
GU6212LPN	Pearl nickel	1
GU6212LBN	Black nickel	1
GU6212LPB	Polished brass	1

2 gang 2 way 100W/VA LED



GU6222LPC

Product code	Description	Pack qty
GU6222LSS	Stainless steel	1
GU6222LPC	Polished chrome	1
GU6222LPW	Painted white	1
GU6222LPN	Pearl nickel	1
GU6222LBN	Black nickel	1
GU6222LPB	Polished brass	1

3 gang 2 way 75W/VA LED



GU6232LPC

Product code	Description	Pack qty
GU6232LSS	Stainless steel	1
GU6232LPC	Polished chrome	1
GU6232LPW	Painted white	1
GU6232LPN	Pearl nickel	1
GU6232LBN	Black nickel	1
GU6232LPB	Polished brass	1

- **Standard of compliance:**
BS EN 60669-2-1
- **Mounting box:**
25mm deep (1-2 gang)
35mm deep (3-4 gang)
- **Fixing screws:**
M3.5 x 25mm and 30mm
- **Plate dimensions:**
88 x 88mm (1-2 gang)
88 x 148mm (3-4 gang)
- **Technical notes:**
All dimmers not suitable with CFL lighting.

Mains & low voltage and electronic dimmers not suitable for use with LED lamps.

Mains & low voltage dimmers - leading edge control.

LED dimmers - trailing edge control.
- **Notes:**
Retractive switches are required for Multi-Way Operation when using LED dimmers

Dimmer switches continued

4 gang 2 way 75W/VA LED



GU6242LPC

Product code	Description	Pack qty
GU6242LSS	Stainless steel	1
GU6242LPC	Polished chrome	1
GU6242LPW	Painted white	1
GU6242LPN	Pearl nickel	1
GU6242LBN	Black nickel	1
GU6242LPB	Polished brass	1

1 gang 2 way 300W/VA electronic



GU6212EWPC

Product code	Description	Pack qty
GU6212E*SS	Stainless steel	1
GU6212E*PC	Polished chrome	1
GU6212EWPN	Pearl nickel with white interior	1
GU6212EBBN	Black nickel with black interior	1
GU6212EBPB	Polished brass with black insert	1

2 gang 2 way 200W/VA electronic



GU6222EWPC

Product code	Description	Pack qty
GU6222E*SS	Stainless steel	1
GU6222E*PC	Polished chrome	1
GU6222EWPW	Painted white with white interior	1
GU6222EWPN	Pearl nickel with white interior	1
GU6222EBBN	Black nickel with black interior	1
GU6222E BPB	Polished brass with black insert	1

1 gang 2 way 300W/VA IR electronic



GU6212RWPC

Product code	Description	Pack qty
GU6212R*SS	Stainless steel	1
GU6212RBPC	Polished chrome with black interior	1
GU6212RWPW	Painted white with white interior	1
GU6212RWPN	Pearl nickel with white interior	1
GU6212RBBN	Black nickel with black interior	1
GU6000RC1R	1 channel IR remote control	1

- **Standard of compliance:**
BS EN 60669-2-1
- **Mounting box:**
16mm deep (1-2 gang)
35mm deep (3-4 gang)
- **Fixing screws:**
M3.5 x 25mm and 30mm
- **Plate dimensions:**
86 x 86mm (1-2 gang)
88 x 148mm (3-4 gang)
- **Technical notes:**
All dimmers not suitable with CFL lighting.

Mains & low voltage and electronic dimmers not suitable for use with LED lamps.

Mains & low voltage dimmers - leading edge control.

LED dimmers - trailing edge control.

- **Notes:**
Retractive switches are required for Multi-Way Operation when using LED dimmers

Polished brass white interior



Polished brass black interior



Polished chrome white interior



Polished chrome black interior



Pearl nickel white interior



Stainless steel white interior



Stainless steel black interior

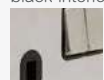

White metal white interior



Black nickel black interior



Control switches

20AX double-pole 1 gang



GU2210WPC

Product code	Description	Pack qty
GU2210*SS	Stainless steel	1
GU2210*PC	Polished chrome	1
GU2210WPC	Painted white with white interior	1
GU2210WPN	Pearl nickel with white interior	1
GU2210BBN	Black nickel with black interior	1
GU2210BPB	Polished brass with black insert	1

- **Standard of compliance:** BS EN 60669-1 (switches)
- **Mounting box:** 35mm deep
- **Fixing screws:** M3.5 x 25mm and 30mm
- **Plate dimensions:** 88 x 88mm

20AX double-pole 1 gang with neon



GU2211WPC

Product code	Description	Pack qty
GU2211*SS	Stainless steel	1
GU2211*PC	Polished chrome	1
GU2211WPC	Painted white with white interior	1
GU2211WPN	Pearl nickel with white interior	1
GU2211BBN	Black nickel with black interior	1
GU2211BPB	Polished brass with black insert	1

20AX double-pole 1 gang with flex outlet



GU2213WPC

Product code	Description	Pack qty
GU2213*SS	Stainless steel	1
GU2213*PC	Polished chrome	1
GU2213WPC	Painted white with white interior	1
GU2213WPN	Pearl nickel with white interior	1
GU2213BBN	Black nickel with black interior	1
GU2213BPB	Polished brass with black insert	1

20AX double-pole 1 gang with neon & flex outlet



GU2214WPC

Product code	Description	Pack qty
GU2214*SS	Stainless steel	1
GU2214*PC	Polished chrome	1
GU2214WPC	Painted white with white interior	1
GU2214WPN	Pearl nickel with white interior	1
GU2214BBN	Black nickel with black interior	1
GU2214 BPB	Polished brass with black insert	1

20AX double-pole 1 gang with neon & flex outlet printed water heater



GU2214WHWPC

Product code	Description	Pack qty
GU2214WH*SS	Stainless steel	1
GU2214WH*PC	Polished chrome	1
GU2214WHWPC	Painted white with white interior	1
GU2214WHWPN	Pearl nickel with white interior	1
GU2214WHBBN	Black nickel with black interior	1
GU2214WHBPB	Polished brass with black insert	1

32A double-pole 1 gang with neon



GU4231WPC

Product code	Description	Pack qty
GU4231*SS	Stainless steel	1
GU4231*PC	Polished chrome	1
GU4231WPW	Painted white with white interior	1
GU4231WPN	Pearl nickel with white interior	1
GU4231BBN	Black nickel with black interior	1
GU4231BPB	Polished brass with black insert	1

Fused connection units

13A unswitched



GU5200WPC

Product code	Description	Pack qty
GU5200*SS	Stainless steel	1
GU5200*PC	Polished chrome	1
GU5200WPW	Painted white with white interior	1
GU5200WPN	Pearl nickel with white interior	1
GU5200BBN	Black nickel with black interior	1
GU5200BPB	Polished brass with black insert	1

- **Standard of compliance:** BS 1363
- **Mounting box:** 25mm deep (unswitched) 35mm deep (switched)
- **Fixing screws:** M3.5 x 25mm and 30mm
- **Plate dimensions:** 88 x 88mm

13A unswitched with flex outlet



GU5203WPC

Product code	Description	Pack qty
GU5203*SS	Stainless steel	1
GU5203*PC	Polished chrome	1
GU5203WPW	Painted white with white interior	1
GU5203WPN	Pearl nickel with white interior	1
GU5203BBN	Black nickel with black interior	1
GU5203BPB	Polished brass with black insert	1

13A double-pole switched



GU5210WPC

Product code	Description	Pack qty
GU5210*SS	Stainless steel	1
GU5210*PC	Polished chrome	1
GU5210WPW	Painted white with white interior	1
GU5210WPN	Pearl nickel with white interior	1
GU5210BBN	Black nickel with black interior	1
GU5210BPB	Polished brass with black insert	1

Polished brass white interior



Polished brass black interior



Polished chrome white interior



Polished chrome black interior



Pearl nickel white interior



Stainless steel white interior



Stainless steel black interior



White metal white interior



Black nickel black interior



Fused connection units continued

13A double-pole switched with neon



GU5211WPC

Product code	Description	Pack qty
GU5211*SS	Stainless steel	1
GU5211*PC	Polished chrome	1
GU5211WPW	Painted white with white interior	1
GU5211WPN	Pearl nickel with white interior	1
GU5211BBN	Black nickel with black interior	1
GU5211BPB	Polished brass with black insert	1

- **Standard of compliance:**
BS 1363
- **Mounting box:**
25mm deep (unswitched)
35mm deep (switched)
- **Fixing screws:**
M3.5 x 25mm and 30mm
- **Plate dimensions:**
88 x 88mm

13A double-pole switched with flex outlet



GU5213WPC

Product code	Description	Pack qty
GU5213*SS	Stainless steel	1
GU5213*PC	Polished chrome	1
GU5213WPW	Painted white with white interior	1
GU5213WPN	Pearl nickel with white interior	1
GU5213BBN	Black nickel with black interior	1
GU5213 BPB	Polished brass with black insert	1

13A double-pole switched with neon & flex outlet



GU5214WPC

Product code	Description	Pack qty
GU5214*SS	Stainless steel	1
GU5214*PC	Polished chrome	1
GU5214WPW	Painted white with white interior	1
GU5214WPN	Pearl nickel with white interior	1
GU5214BBN	Black nickel with black interior	1
GU5214BPB	Polished brass with black insert	1

High current switches

50A 2 gang double-pole switches with neon



GU4221WPC

Product code	Description	Pack qty
GU4221*SS	Stainless steel	1
GU4221*PC	Polished chrome	1
GU4221WPW	Painted white with white interior	1
GU4221WPN	Pearl nickel with white interior	1
GU4221BBN	Black nickel with black interior	1
GU4221BPB	Polished brass with black insert	1

- **Standard of compliance:** BS EN 60669-1 (switches) BS 4177 (cooker control units)

- **Mounting box:** 47mm deep

- **Fixing screws:** M3.5 x 25mm and 30mm

- **Plate dimensions:** 148 x 88mm (switches), 88 x 148mm (cooker control units)

45A double-pole cooker control unit with 13A switched socket & neons

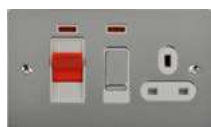

GU4201WPC

Product code	Description	Pack qty
GU4201*SS	Stainless steel	1
GU4201*PC	Polished chrome	1
GU4201WPW	Painted white with white interior	1
GU4201WPN	Pearl nickel with white interior	1
GU4201BBN	Black nickel with black interior	1
GU4201BPB	Polished brass with black insert	1

Shaver socket

115/230V dual voltage



GU7290WPC

Product code	Description	Pack qty
GU7290*SS	Stainless steel	1
GU7290*PC	Polished chrome	1
GU7290WPW	Painted white with white interior	1
GU7290WPN	Pearl nickel with white interior	1
GU7290BBN	Black nickel with black interior	1
GU7290BPB	Polished brass with black insert	1

- **Standard of compliance:** BS EN 61558-2-5

- **Mounting box:** 47mm deep

- **Fixing screws:** M3.5 x 25mm and 30mm

- **Plate dimensions:** 148 x 88mm

- **Technical notes:** Unique design allows perfect fit to 47mm box.

Telephone outlets

Single RJ11



GU7251WPC

Product code	Description	Pack qty
GU7251*SS	Stainless steel	1
GU7251WPC	Polished chrome with white interior	1
GU7251WPW	Painted white with white interior	1
GU7251WPN	Pearl nickel with white interior	1
GU7251BBN	Black nickel with black interior	1
GU7251BPB	Polished brass with black insert	1

- **Standard of compliance:** BS EN 41003
- **Mounting box:** Minimum 25mm deep
- GU7251***: minimum 35mm deep
- **Fixing screws:** M3.5 x 25mm and 30mm
- **Plate dimensions:** 88 x 88mm
- **Technical notes:** Refer to euro plates and modules section for combined telephone & data solutions.

Master BT telephone



GU7261WPC

Product code	Description	Pack qty
GU7261*SS	Stainless steel	1
GU7261*PC	Polished chrome	1
GU7261WPW	Painted white with white interior	1
GU7261WPN	Pearl nickel with white interior	1
GU7261BBN	Black nickel with black interior	1
GU7261BPB	Polished brass with black insert	1

Secondary BT telephone



GU7262WPC

Product code	Description	Pack qty
GU7262*SS	Stainless steel	1
GU7262*PC	Polished chrome	1
GU7262WPW	Painted white with white interior	1
GU7262WPN	Pearl nickel with white interior	1
GU7262BBN	Black nickel with black interior	1
GU7262BPB	Polished brass with black insert	1

Data outlets

RJ45 CAT5e



GU7271WPC

Product code	Description	Pack qty
GU7271*SS	Stainless steel	1
GU7271*PC	Polished chrome	1
GU7271WPW	Painted white with white interior	1
GU7271WPN	Pearl nickel with white interior	1
GU7271BBN	Black nickel with black interior	1
GU7271BPB	Polished brass with black insert	1

- **Standard of compliance:** BS EN 41003
- **Mounting box:** Minimum 25mm deep
- **Fixing screws:** M3.5 x 25mm and 30mm
- **Plate dimensions:** 88 x 88mm
- **Technical notes:** Refer to euro plates and modules section for combined telephone & data solutions.

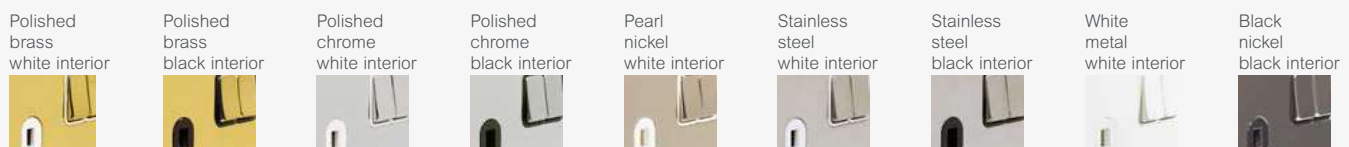

TV outlets

Single TV/FM



GU7210WPC

Product code	Description	Pack qty
GU7210*SS	Stainless steel	1
GU7210*PC	Polished chrome	1
GU7210WPW	Painted white with white interior	1
GU7210WPN	Pearl nickel with white interior	1
GU7210BBN	Black nickel with black interior	1
GU7210BPB	Polished brass with black insert	1

- **Standard of compliance:** BS 3041 (where applicable)
- **Mounting box:** 35mm deep
- **Fixing screws:** M3.5 x 25mm and 30mm
- **Plate dimensions:** 88 x 88mm
- **Technical notes:** Products are direct connection and are not suitable for common connection

Twin TV/FM



GU7220WPC

Product code	Description	Pack qty
GU7220*SS	Stainless steel	1
GU7220*PC	Polished chrome	1
GU7220WPW	Painted white with white interior	1
GU7220WPN	Pearl nickel with white interior	1
GU7220BBN	Black nickel with black interior	1
GU7220BPB	Polished brass with black insert	1

Single Satellite



GU7230WPC

Product code	Description	Pack qty
GU7230*SS	Stainless steel	1
GU7230*PC	Polished chrome	1
GU7230WPW	Painted white with white interior	1
GU7230WPN	Pearl nickel with white interior	1
GU7230BBN	Black nickel with black interior	1
GU7230BPB	Polished brass with black insert	1

Euro modular plates & modules

1 gang euro plate, 1 module 25 x 50mm



GU8250PC

Product code	Description	Pack qty
GU8250SS	Stainless steel	1
GU8250PC	Polished chrome	1
GU8250PW	Painted white	1
GU8250PN	Pearl nickel	1
GU8250BN	Black nickel	1
GU8250PB	Polished brass	1

- **Mounting box:** Refer to module for appropriate mounting box depth
- **Plate dimensions:** 88 x 88mm (1 gang)
- **Technical notes:** Mounting grid supplied with euro plate.
- Euro modules plates compatible with Schneider Electric euro modules.
- **Note:** modules from other suppliers may not be compatible, it is advised to check suitability.

1 gang euro plate, 2 module 50 x 50mm



GU8260PC

Product code	Description	Pack qty
GU8260SS	Stainless steel	1
GU8260PC	Polished chrome	1
GU8260PW	Painted white	1
GU8260PN	Pearl nickel	1
GU8260BN	Black nickel	1
GU8260PB	Polished brass	1

2 gang euro plate, 4 module 100 x 50mm



GU8280PC

Product code	Description	Pack qty
GU8280SS	Stainless steel	1
GU8280PC	Polished chrome	1
GU8280PW	Painted white	1
GU8280PN	Pearl nickel	1
GU8280BN	Black nickel	1
GU8280PB	Polished brass	1

- **Mounting box:** Refer to module for appropriate mounting box depth
- **Plate dimensions:** 88 x 148mm (2 gang)
- **Technical notes:** Mounting grid supplied with euro plate.
- Euro modules plates compatible with Schneider Electric euro modules.
- **Note:** modules from other suppliers may not be compatible, it is advised to check suitability.

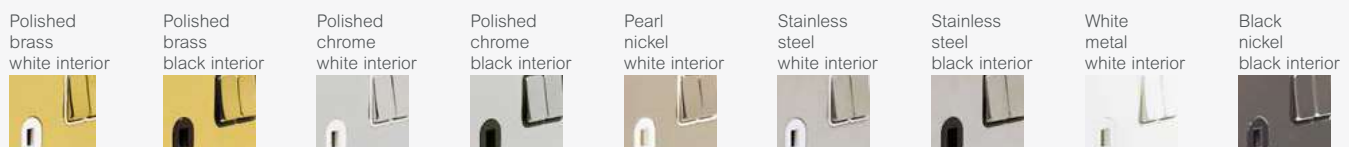

25 x 50mm euro modules



Product code	Description	Pack qty
GUE7011*	Single IEC coax (female)	1
GUE7012*	Single IEC coax (male)	1
GUE7030*	Single F type sat	1
GUE7061*	BT master telephone	1
GUE7062*K	BT secondary telephone	1
GUE7071*	RJ45 CAT5e (not screened)	1
GUE7072*	RJ45 CAT6 (not screened)	1
GUE7073*	Single USB charger 1A 5Vdc	1
GUE7051*	RJ11 modem	1
GUE7075*	VGA	1
GUE7091*	LexCom Performance outlet	8
GUE7000*	2 x Phono socket	1
GUE7001*	2 x Loudspeaker socket	1
GUE8010*	Blank module	5

- **Mounting box:**
25mm deep (25 x 50mm modules)
- **Euro module dimensions:**
25 x 50mm (single)

50 x 50mm euro modules



Product code	Description	Pack qty
GUE7010*	TV/FM diplexer	1
GUE7040*	TV/Sat diplexer	1
GUE7074*	Twin USB charger 2 x 1A 5Vdc	1
GUE7081*	TV/FM/Sat triplexer	1
GUE7082*	TV/FM/Sat1/Sat2 quadplexer	1
GUE7020*	HDMI	1
GGBLGUE7078*	American power socket	1
GUE7076*	Brush outlet	1
GUE7077*	5A round pin socket	1
GGBGUE7079*	European socket	1

- **Mounting box:**
35mm deep (50 x 50mm modules)
- **Euro module dimensions:**
50 x 50mm (double)
- MTO products for projects only, leadtime to be confirmed at time of ordering

Blank plates & accessories

1 gang



GU8210PC

Product code	Description	Pack qty
GU8210SS	Stainless steel	1
GU8210PC	Polished chrome	1
GU8210PW	Painted white	1
GU8210PN	Pearl nickel	1
GU8210BN	Black nickel	1
GU8210PB	Polished brass	1

- **Standard of compliance:** BS 5733
- **Fixing screws:** M3.5 x 25mm and 30mm
- **Plate dimensions:** 88 x 88mm (1 gang)
88 x 148mm (2 gang)

2 gang



GU8220PC

Product code	Description	Pack qty
GU8220SS	Stainless steel	1
GU8220PC	Polished chrome	1
GU8220PW	Painted white	1
GU8220PN	Pearl nickel	1
GU8220BN	Black nickel	1
GU8220PB	Polished brass	1
3746130	M3.5 x 25mm raised head machine screws	100
USCREW50SS	M3.5 x 50mm screws	100

Grid plates

1 gang 88 x 88mm



GUG01GSS

Product code	Description	Pack qty
GUG01GSS	Stainless steel	1
GUG01GMS	Mirror steel	1
GUG01GPW	Painted white	1
GUG01GPN	Pearl nickel	1
GUG01GBN	Black nickel	1
GUG01GPB	Polished brass	1
GBG01	76 x 76 x 42mm back box	1

- **Mounting box:** 42mm deep
- **Technical notes:** All grid plates are supplied with the appropriate number of mounting frames.

Mirror steel used for polished chrome grid plates & modules.

2 gang 88 x 88mm



GUG02GMS

Product code	Description	Pack qty
GUG02GSS	Stainless steel	1
GUG02GMS	Mirror steel	1
GUG02GPW	Painted white	1
GUG02GPN	Pearl nickel	1
GUG02GBN	Black nickel	1
GUG02GPB	Polished brass	1
GBG01	76 x 76 x 42mm back box	1

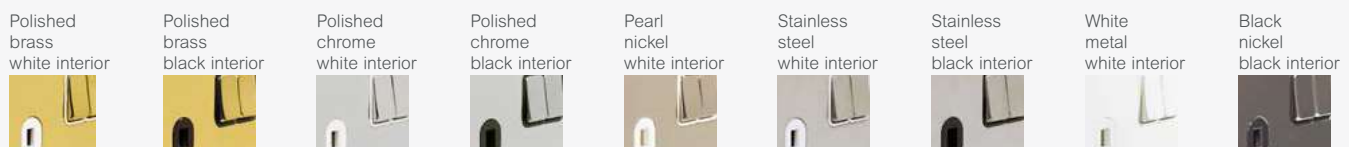

Grid plates continued

3 gang 88 x 148mm



GUG03GMS

Product code	Description	Pack qty
GUG03GSS	Stainless steel	1
GUG03GMS	Mirror steel	1
GUG03GPW	Painted white	1
GUG03GPN	Pearl nickel	1
GUG03GBN	Black nickel	1
GUG03GPB	Polished brass	1
GBG02	136 x 76 x 42mm back box	1

- **Mounting box:**
42mm deep

- **Technical notes:**
All grid plates are supplied with the appropriate number of mounting frames.

Mirror steel used for polished chrome grid plates & modules.

4 gang 88 x 148mm



GUG04GMS

Product code	Description	Pack qty
GUG04GSS	Stainless steel	1
GUG04GMS	Mirror steel	1
GUG04GPW	Painted white	1
GUG04GPN	Pearl nickel	1
GUG04GBN	Black nickel	1
GUG04GPB	Polished brass	1
GBG02	136 x 76 x 42mm back box	1

6 gang 156 x 156mm



GUG06GMS

Product code	Description	Pack qty
GUG06GSS	Stainless steel	1
GUG06GMS	Mirror steel	1
GUG06GPW	Painted white	1
GUG06GPN	Pearl nickel	1
GUG06GBN	Black nickel	1
GUG06GPB	Polished brass	1
GBG03	136 x 136 x 42mm back box	1

8 gang 156 x 156mm



GUG08GMS

Product code	Description	Pack qty
GUG08GSS	Stainless steel	1
GUG08GMS	Mirror steel	1
GUG08GPW	Painted white	1
GUG08GPN	Pearl nickel	1
GUG08GBN	Black nickel	1
GUG08GPB	Polished brass	1
GBG03	136 x 136 x 42mm back box	1

9 gang 216 x 156mm



GUG09GMS

Product code	Description	Pack qty
GUG09GSS	Stainless steel	1
GUG09GMS	Mirror steel	1
GUG09GPW	Painted white	1
GUG09GPN	Pearl nickel	1
GUG09GBN	Black nickel	1
GUG09GPB	Polished brass	1
GBG04F	193 x 133 x 42mm back box	1

Grid plates continued

12 gang 216 x 156mm



GUG12GMS

Product code	Description	Pack qty
GUG12GSS	Stainless steel	1
GUG12GMS	Mirror steel	1
GUG12GPW	Painted white	1
GUG12GPN	Pearl nickel	1
GUG12GBN	Black nickel	1
GUG12GPB	Polished brass	1
GBG04F	193 x 133 x 42mm back box	1

- **Mounting box:**
42mm deep
- **Technical notes:**
All grid plates are supplied with the appropriate number of mounting frames.

Mirror steel used for polished chrome grid plates & modules.

18 gang 398 x 156mm



GUG18GMS

Product code	Description	Pack qty
GUG18GSS	Stainless steel	1
GUG18GMS	Mirror steel	1
GUG18GPW	Painted white	1
GUG18GPN	Pearl nickel	1
GUG18GBN	Black nickel	1
GUG18GPB	Polished brass	1
GBG06F	374 x 133 x 42mm back box	1

24 gang 398 x 156mm



GUG24GMS

Product code	Description	Pack qty
GUG24GSS	Stainless steel	1
GUG24GMS	Mirror steel	1
GUG24GPW	Painted white	1
GUG24GPN	Pearl nickel	1
GUG24GBN	Black nickel	1
GUG24GPB	Polished brass	1
GBG06F	374 x 133 x 42mm back box	1

Customisable switch grid modules

10AX metal switch module components (white or black surrounds)



GUG102MB GUG101MW

Product code	Description	Pack qty
GUG101M*	10AX 1 way SP	1
GUG102M*	10AX 2 way SP	1
GUG101M*	10AX intermediate SP	1

20AX metal switch module components (white or black surrounds)



GUG2020MB GUG20DPMW

Product code	Description	Pack qty
GUG201M*	20AX 1 way SP	1
GUG2020M*	20AX 2 way and centre off SP	1
GUG202M*	20AX 2 way SP	1
GUG20DPM*	20AX DP	1

- **Standard of compliance:** BS EN 60669-1
- **Mounting box:** 42mm deep
- **Technical notes:** 10AX & 20AX metal switch module components available in black or white.
- Clear terminal marking printed onto grey switch module component back mouldings ensures easy identification.
- Pre-printed rocker caps
- Easy assembly

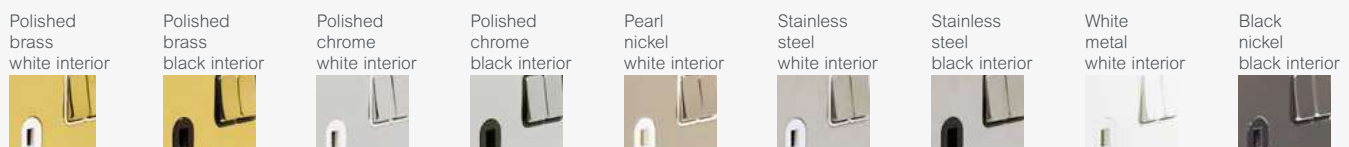
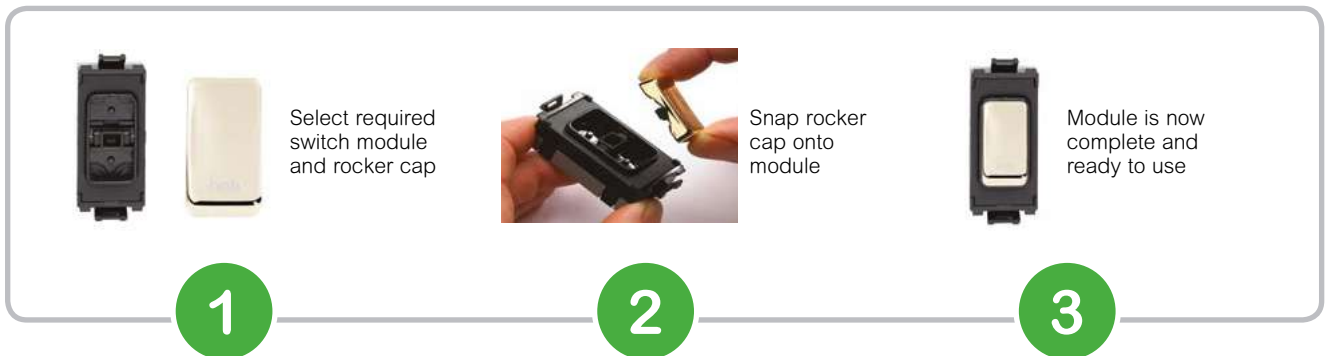

Plain and printed rocker caps for component modules



	Stainless Steel	Mirror Steel	Polished Brass	Pearl Nickel	Painted White	Black Nickel	Painted Black
Plain rocker cap	GUGRSS	GUGRMS	GUGRPB	GUGRPN	GUGRPW	GUGRBN	GUGRBLK
Rocker cap printed boiler	GUGRBOSS	GUGRBOMS	GUGRBOPB	GUGRBOPN	GUGRBOPW	GUGRBOBN	GUGRBOBLK
Rocker cap printed cooker hood	GUGRCHSS	GUGRCHMS	GUGRCHPB	GUGRCHPN	GUGRCHPW	GUGRCHBN	GUGRCHBLK
Rocker cap printed dish washer	GUGRDWSS	GUGRDWMS	GUGRDWPB	GUGRDWPN	GUGRDWPW	GUGRDWBN	GUGRDWBLK
Rocker cap printed extractor fan	GUGREFSS	GUGREFMS	GUGREFPB	GUGREFPN	GUGREFPW	GUGREFBN	GUGREFBLK
Rocker cap printed fridge	GUGRFRSS	GUGRFRMS	GUGRFRPB	GUGRFRPN	GUGRFRPW	GUGRFRBN	GUGRFRBLK
Rocker cap printed fan	GUGRFASS	GUGRFAMS	GUGRFAPB	GUGRFAPN	GUGRFAPW	GUGRFABN	GUGRFABLK
Rocker cap printed freezer	GUGRFZSS	GUGRFZMS	GUGRFZPB	GUGRFZPN	GUGRFZPW	GUGRFZBN	GUGRFZBLK
Rocker cap printed fridge/freezer	GUGRFRFZSS	GUGRFRFZMS	GUGRFRFZPB	GUGRFRFZPN	GUGRFRFZPW	GUGRFRFZBN	GUGRFRFZBLK
Rocker cap printed hob	GUGRHOSS	GUGRHOMS	GUGRHOPB	GUGRHOPN	GUGRHOPW	GUGRHOBN	GUGRHOBK
Rocker cap printed heater	GUGRHESS	GUGRHEMS	GUGRHEPB	GUGRHEPN	GUGRHEPW	GUGRHEBN	GUGRHEBLK
Rocker cap printed microwave	GUGRMWSS	GUGRMWMS	GUGRMWPB	GUGRMWPN	GUGRMWPW	GUGRMWBN	GUGRMWBLK
Rocker cap printed oven	GUGROVSS	GUGROVMS	GUGROVPB	GUGROVPN	GUGROVPW	GUGROVBN	GUGROVBLK
Rocker cap printed tumble dryer	GUGRTDSS	GUGRTDMS	GUGRTDPB	GUGRTDPN	GUGRTDPW	GUGRTDBN	GUGRTDBLK
Rocker cap printed washer dryer	GUGRWDYSS	GUGRWDYMS	GUGRWDYPB	GUGRWDYPN	GUGRWDYPW	GUGRWDYBN	GUGRWDYBLK
Rocker cap printed waste disposal	GUGRWDSS	GUGRWDMS	GUGRWDPB	GUGRWDPN	GUGRWDPW	GUGRWDNB	GUGRWDNBK
Rocker cap printed washing machine	GUGRWMSS	GUGRWMMS	GUGRWMPB	GUGRWMPN	GUGRWMPW	GUGRWMBN	GUGRWMBLK

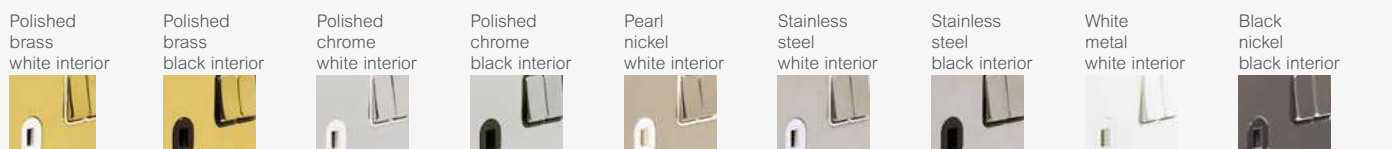

Retractive & toggle switch grid modules

6A 2 way retractive and centre off



GUG202OCWMS

Product code	Description	Pack qty
GUG202OC*SS	Stainless steel	1
GUG202OC*MS	Mirror steel	1
GUG202OCWPW	Painted white with white interior	1
GUG202OCWPN	Pearl nickel with white interior	1
GUG202OCBBN	Black nickel with black interior	1
GUG202OC*PB	Polished brass	1

- **Standard of compliance:**
BS EN 60669-1
- **Mounting box:**
42mm deep
- **Technical notes:**
Mirror steel used for polished chrome grid plates & modules.

10AX 2 way retractive single-pole



GUG102RWMS

Product code	Description	Pack qty
GUG102R*SS	Stainless steel	1
GUG102R*MS	Mirror steel	1
GUG102RWPW	Painted white with white interior	1
GUG102RWPN	Pearl nickel with white interior	1
GUG102RBBN	Black nickel with black interior	1
GUG102R*PB	Polished brass	1

10A 2 way single-pole toggle



GUG102TWMS

Product code	Description	Pack qty
GUG102T*SS	Stainless steel	1
GUG102T*MS	Mirror steel	1
GUG102TWPW	Painted white with white interior	1
GUG102TWPN	Pearl nickel with white interior	1
GUG102TBBN	Black nickel with black interior	1
GUG102T*PB	Polished brass	1

10AX intermediate toggle



GUG10ITWMS

Product code	Description	Pack qty
GUG10IT*SS	Stainless steel	1
GUG10IT*MS	Mirror steel	1
GUG10ITWPW	Painted white with white interior	1
GUG10ITWPN	Pearl nickel with white interior	1
GUG10ITBBN	Black nickel with black interior	1
GUG10IT*PB	Polished brass	1

Key switch grid modules

20AX 1 way key operated double-pole



GUG20DPKWMS

Product code	Description	Pack qty
GUG20DPK*SS	Stainless steel	1
GUG20DPK*MS	Mirror steel	1
GUG20DPKW PW	Painted white with white interior	1
GUG20DPKW PN	Pearl nickel with white interior	1
GUG20DPKBBN	Black nickel with black interior	1
GUG20DPK*PB	Polished brass	1

- **Standard of compliance:** BS EN 60669-1
- **Mounting box:** 42mm deep
- **Technical notes:** Mirror steel used for polished chrome grid plates & modules.

20AX 2 way key operated



GUG202KWMS

Product code	Description	Pack qty
GUG202K*SS	Stainless steel	1
GUG202K*MS	Mirror steel	1
GUG202KW PW	Painted white with white interior	1
GUG202KW PN	Pearl nickel with white interior	1
GUG202KBBN	Black nickel with black interior	1
GUG202K*PB	Polished brass	1

20AX 2 way key operated printed red TEST EMG LTG



GUG202KELWMS

Product code	Description	Pack qty
GUG202KEL*SS	Stainless steel	1
GUG202KEL*MS	Mirror steel	1
GUG202KELW PW	Painted white with white interior	1
GUG202KELW PN	Pearl nickel with white interior	1
GUG202KELBBN	Black nickel with black interior	1
GUG202KEL*PB	Polished brass	1

Polished brass white interior



Polished brass black interior



Polished chrome white interior



Polished chrome black interior



Pearl nickel white interior



Stainless steel white interior



Stainless steel black interior



White metal white interior



Black nickel black interior



Telephone grid modules

BT master telephone



GUGTELMWMS

Product code	Description	Pack qty
GUGTELM*SS	Stainless steel	1
GUGTELM*MS	Mirror steel	1
GUGTELMWPW	Painted white with white interior	1
GUGTELMWPN	Pearl nickel with white interior	1
GUGTELMBBN	Black nickel with black interior	1
GUGTELM*PB	Polished brass	1

- **Standard of compliance:**
BS EN 3041 (where applicable)
- **Mounting box:**
42mm deep
- **Technical notes:**
Mirror steel used for polished chrome grid plates & modules.

BT secondary telephone



GUGTELSWMS

Product code	Description	Pack qty
GUGTELS*SS	Stainless steel	1
GUGTELS*MS	Mirror steel	1
GUGTELSWPW	Painted white with white interior	1
GUGTELSWPN	Pearl nickel with white interior	1
GUGTELSBBN	Black nickel with black interior	1
GUGTELS*PB	Polished brass	1

RJ11 telephone



GUGRJ11WMS

Product code	Description	Pack qty
GUGRJ11*SS	Stainless steel	1
GUGRJ11*MS	Mirror steel	1
GUGRJ11WPW	Painted white with white interior	1
GUGRJ11WPN	Pearl nickel with white interior	1
GUGRJ11BBN	Black nickel with black interior	1
GUGRJ11*PB	Polished brass	1

Data & TV grid modules

RJ45 CAT5e



GUGRJ45WMS

Product code	Description	Pack qty
GUGRJ45*SS	Stainless steel	1
GUGRJ45*MS	Mirror steel	1
GUGRJ45WPW	Painted white with white interior	1
GUGRJ45WPN	Pearl nickel with white interior	1
GUGRJ45BBN	Black nickel with black interior	1
GUGRJ45*PB	Polished brass	1

- **Standard of compliance:** BS EN 3041 (where applicable)
- **Mounting box:** 42mm deep
- **Technical notes:** Mirror steel used for polished chrome grid plates & modules.

Direct coaxial TV



GUGCOWMS

Product code	Description	Pack qty
GUGCO*SS	Stainless steel	1
GUGCO*MS	Mirror steel	1
GUGCOWPW	Painted white with white interior	1
GUGCOWPN	Pearl nickel with white interior	1
GUGCOBBN	Black nickel with black interior	1
GUGCO*PB	Polished brass	1

F type satellite



GUGSATWMS

Product code	Description	Pack qty
GUGSAT*SS	Stainless steel	1
GUGSAT*MS	Mirror steel	1
GUGSATWPW	Painted white with white interior	1
GUGSATWPN	Pearl nickel with white interior	1
GUGSATBBN	Black nickel with black interior	1
GUGSAT*PB	Polished brass	1

Electronic dimmer grid modules

300W/VA universal multiway touch dimmer module



GUGEMDIMB16

Product code	Description	Pack qty
GUGEMDIM*SS16	Stainless steel	1
GUGEMDIM*MS16	Mirror steel	1
GUGEMDIMWPW16	Painted white with white interior	1
GUGEMDIMWPN16	Pearl nickel with white interior	1
GUGEMDIMBBN16	Black nickel with black interior	1
GUGEMDIMBPB16	Polished brass with black interior	1

- **Mounting box:** 42mm deep
- **Technical notes:** Min load 60W/50VA. Mirror steel used for polished chrome grid plates & modules.

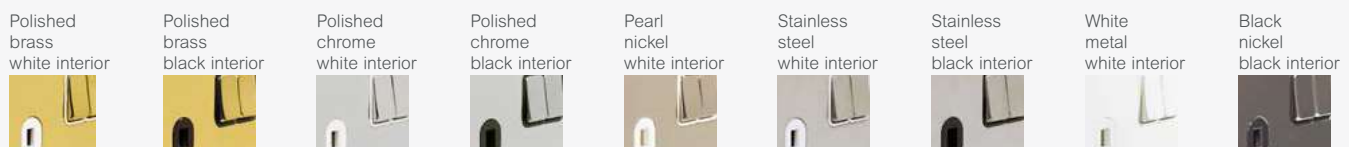

Electronic dimmer grid modules continued

300W/VA universal multiway touch dimmer module with infra red remote option (black or white)



GUGEMRDIMW16

Product code	Description	Pack qty
GUGEMRDIMW16	White	1
GUGEMRDIMB16	Black	1
GU6000RC1R	1 channel IR remote control	1

- Electronic modules are capable of 2 way or multiway dimming.
- Retractive switch for use with electronic dimmers only.
- Not compatible with moulded grid plates.
- Modules will require derating when used in multi-gang applications.

50mA 2 way & multiway retractive switch module



GUGEMWBBN

Product code	Description	Pack qty
GUGEMW*SS	Stainless steel	1
GUGEMW*MS	Mirror steel	1
GUGEMWWPW	Painted white with white interior	1
GUGEMWWPN	Pearl nickel with white interior	1
GUGEMWBBN	Black nickel with black interior	1
GUGEMW*PB	Polished brass	1

Fuse carrier, flex outlet & blank grid modules

13A fuse carrier



GUG13FCUWMS

Product code	Description	Pack qty
GUG13FCU*SS	Stainless steel	1
GUG13FCU*MS	Mirror steel	1
GUG13FCUWPW	Painted white with white interior	1
GUG13FCUWPN	Pearl nickel with white interior	1
GUG13FCUBBN	Black nickel with black interior	1
GUG13FCU*PB	Polished brass	1

- **Standard of compliance:**
BS 1363 (fuse carrier)
BS 5733
- **Mounting box:**
42mm deep
- **Technical notes:**
Full metal surround on all modules
Modules are completely interchangeable

Flex outlet up to 10mm ø



GUG16COWMS

Product code	Description	Pack qty
GUG16CO*SS	Stainless steel	1
GUG16CO*MS	Mirror steel	1
GUG16COWPW	Painted white with white interior	1
GUG16COWPN	Pearl nickel with white interior	1
GUG16COBBN	Black nickel with black interior	1
GUG16CO*PB	Polished brass	1

Mirror steel used for polished chrome grid plates & modules.

Blank



GUGBWMS

Product code	Description	Pack qty
GUGB*SS	Stainless steel	1
GUGB*MS	Mirror steel	1
GUGBWPW	Painted white with white interior	1
GUGBWPW	Pearl nickel with white interior	1
GUGBBBN	Black nickel with black interior	1
GUGB*PB	Polished brass	1
GUGB*	Moulded plastic (black or white)	1

Indicator modules

White surround



GUGINDWG



GUGINDWR



GUGINDWO

Product code	Description	Pack qty
GUGINDWG	Green indicator	1
GUGINDWR	Red indicator	1
GUGINDWO	Orange indicator	1

- **Standard of compliance:**
BS 5733
- **Technical notes:**
240V

Black surround



GUGINDBG



GUGINDBR



GUGINDBO

Product code	Description	Pack qty
GUGINDBG	Green indicator	1
GUGINDBR	Red indicator	1
GUGINDBO	Orange indicator	1

Flush galvanised steel boxes

16mm deep



SB161

Product code	Description	Pack qty
SB161	1 gang	20

- **Standard of compliance:** BS4662

- **Technical notes:** Supplied with earth terminal and screw.

Supplied with fixed and adjustable lugs.

Fitted with selection of 20mm knockouts in sides and back.

25mm deep



SB252

Product code	Description	Pack qty
SB251	1 gang	10
SB252	2 gang	10

35mm deep



SB351

Product code	Description	Pack qty
SB351	1 gang	10
SB352	2 gang	5

47mm deep



SB472

Product code	Description	Pack qty
SB471	1 gang	10
SB472	2 gang	4

ULTIMATE Low Profile

An ideal upgrade solution for remodel and renovation projects, Ultimate Low Profile offers a contemporary and refreshing twist on traditional designs with its softly curved edge and quality metal finishes.

The forgiving 5mm plate depth provides generous wiring space and is useful when presented with uneven wall surfaces.

5mm Raised Edge offers easy installation access for new developments and remodel projects

Consistent profiles throughout the range allow accessories to be mounted adjacently

Colour-matched flat headed screws and eyelets add a finishes touch, while limiting the amount of tools needed for installation

Large plate footprint provides extra strength and reduces the need for additional decorating

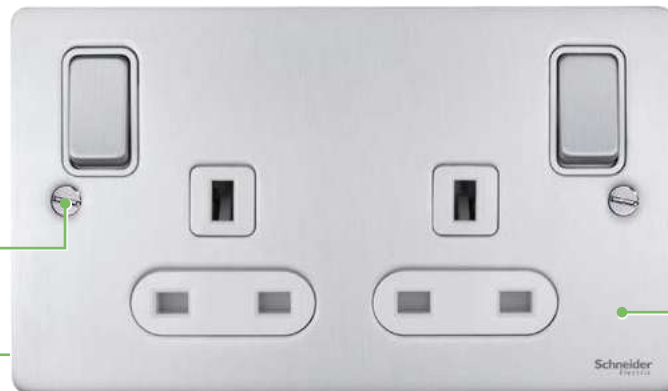

Colour coded socket terminals and printed terminal numbering ensure that cable installation is simple and straight forward.

Long and Short Screws supplied with all low profile accessories for installation flexibility

Plated earth straps prevent corrosion, while inline angled terminals offer easy cable access during installation.

Specification Highlights:



16AX switch rating across all plate switches offers a future-proofed lighting solution to accommodate increased load requirements & fluorescent lighting demands



50A rated plate switches for switching appliances with higher current ratings, such as heaters, cookers and commercial refrigerating units



Choose from a wide range of printed rocker caps to meet you customer requirements, with bespoke options available.



Schneider
Electric

Schneider
Electric

Schneider
Electric

Schneider
Electric

Schneider
Electric

Schneider
Electric

(white)

Socket outlets

13A 1 gang single-pole switched



GU3510BBC

Product code	Description	Pack qty
GU3510*BC	Brushed chrome	1
GU3510*PC	Polished chrome	1

13A 2 gang single-pole switched



GU3520BBC

Product code	Description	Pack qty
GU3520*BC	Brushed chrome	1
GU3520*PC	Polished chrome	1

13A 2 gang double-pole switched with outboard rockers



GU3530BBC

Product code	Description	Pack qty
GU3530*BC	Brushed chrome	1
GU3530*PC	Polished chrome	1

5A unswitched round pin



GU3580BBC

Product code	Description	Pack qty
GU3580*BC	Brushed chrome	1
GU3580*PC	Polished chrome	1

- **Standard of compliance:**
BS 1363 (13A)
BS 546 (round pin)
- **Mounting box:**
Minimum 25mm deep
- **Fixing screws:**
M3.5 x 25mm and 30mm
- **Plate dimensions:**
88 x 88mm (1 gang)
88 x 148mm (2 gang)
- **Technical notes:**
All 2 gang sockets supplied with twin earth terminals as standard.

Plate switches

16AX 1 gang 2 way



GU1512BBC

Product code	Description	Pack qty
GU1512*BC	Brushed chrome	1
GU1512*PC	Polished chrome	1

16AX 1 gang intermediate



GU1514BBC

Product code	Description	Pack qty
GU1514*BC	Brushed chrome	1
GU1514*PC	Polished chrome	1

16AX 2 gang 2 way



GU1522BBC

Product code	Description	Pack qty
GU1522*BC	Brushed chrome	1
GU1522*PC	Polished chrome	1

- **Standard of compliance:**
BS EN 60669-1
- **Mounting box:**
16mm deep (1-2 gang)
- **Fixing screws:**
M3.5 x 25mm and 30mm
- **Plate dimensions:**
88 x 88mm (1-3 gang)

Polished chrome
white interior



Polished chrome
black interior



Brushed chrome
white interior



Brushed chrome
black interior



Plate switches continued

16AX 3 gang 2 way



GU1532BBC

Product code	Description	Pack qty
GU1532*BC	Brushed chrome	1
GU1532*PC	Polished chrome	1

16AX 4 gang 2 way



GU1542BBC

Product code	Description	Pack qty
GU1542*BC	Brushed chrome	1
GU1542*PC	Polished chrome	1

10A triple pole isolator



GU1513BBC

Product code	Description	Pack qty
GU1513*BC	Brushed chrome	1
GU1513*PC	Polished chrome	1

- **Standard of compliance:**
BS EN 60669-1
BS EN 60947-3
(GU1513***)
- **Mounting box:**
25mm deep (3-4 gang)
- **Fixing screws:**
M3.5 x 25mm and 30mm
- **Plate dimensions:**
88 x 88mm (1-3 gang),
88 x 148mm (4 gang)

Dimmer switches

1 gang 2 way 400W/VA mains & low voltage



GU6512CBC

Product code	Description	Pack qty
GU6512CBC	Brushed chrome	1
GU6512CPC	Polished chrome	1

2 gang 2 way 250W/VA mains & low voltage



GU6522CBC

Product code	Description	Pack qty
GU6522CBC	Brushed chrome	1
GU6522CPC	Polished chrome	1

3 gang 2 way 250W/VA mains & low voltage



GU6532CBC

Product code	Description	Pack qty
GU6532CBC	Brushed chrome	1
GU6532CPC	Polished chrome	1

- **Standard of compliance:**
BS EN 60669-2-1
- **Mounting box:**
25mm deep (1-2 gang)
35mm deep (3 gang)
- **Fixing screws:**
M3.5 x 25mm and 30mm
- **Plate dimensions:**
88 x 88mm (1-2 gang)
88 x 148mm (3 gang)
- **Technical notes:**
All dimmers not suitable with CFL lighting.

Mains & low voltage and electronic dimmers not suitable for use with LED lamps.

Mains & low voltage dimmers - leading edge control.

Control switches

20AX double-pole 1 gang with neon



GU2511BBC

Product code	Description	Pack qty
GU2511*BC	Brushed chrome	1
GU2511*PC	Polished chrome	1

20AX double-pole 1 gang with flex outlet



GU2513BBC

Product code	Description	Pack qty
GU2513*BC	Brushed chrome	1
GU2513*PC	Polished chrome	1

- **Standard of compliance:** BS EN 60669-1
- **Mounting box:** 35mm deep
- **Fixing screws:** M3.5 x 25mm and 30mm
- **Plate dimensions:** 88 x 88mm

Fused connection units

13A unswitched



GU5500BBC

Product code	Description	Pack qty
GU5500*BC	Brushed chrome	1
GU5500*PC	Polished chrome	1

13A double-pole switched



GU5510BBC

Product code	Description	Pack qty
GU5510*BC	Brushed chrome	1
GU5510*PC	Polished chrome	1

13A double-pole switched with neon



GU5511BBC

Product code	Description	Pack qty
GU5511*BC	Brushed chrome	1
GU5511*PC	Polished chrome	1

13A double-pole switched with neon & flex outlet



GU5514BBC

Product code	Description	Pack qty
GU5514*BC	Brushed chrome	1
GU5514*PC	Polished chrome	1

- **Standard of compliance:** BS 1363
- **Mounting box:** 25mm deep (unswitched) 35mm deep (switched)
- **Fixing screws:** M3.5 x 25mm and 30mm
- **Plate dimensions:** 88 x 88mm

High current switches

50A 2 gang double-pole switches with neon



GU4521BBC

Product code	Description	Pack qty
GU4521*BC	Brushed chrome	1
GU4521*PC	Polished chrome	1

- **Standard of compliance:** BS EN 60669-1 (switches) BS 4177 (cooker control units)

- **Mounting box:** 47mm deep

- **Fixing screws:** M3.5 x 25mm and 30mm

- **Plate dimensions:** 148 x 88mm (switches), 88 x 148mm (cooker control units)

45A double-pole cooker control unit with 13A switched socket & neons



GU4501BBC

Product code	Description	Pack qty
GU4501*BC	Brushed chrome	1
GU4501*PC	Polished chrome	1

Shaver socket

115/230V dual voltage



GU7590BBC

Product code	Description	Pack qty
GU7590*BC	Brushed chrome	1
GU7590*PC	Polished chrome	1

- **Standard of compliance:** BS EN 61558-2-5

- **Mounting box:** 47mm deep

- **Fixing screws:** M3.5 x 25mm and 30mm

- **Plate dimensions:** 148 x 88mm

- **Technical notes:** Unique design allows perfect fit to 47mm box.

Telephone outlets

Master BT telephone



GU7561BBC

Product code	Description	Pack qty
GU7561*BC	Brushed chrome	1
GU7561*PC	Polished chrome	1

- **Standard of compliance:** BS EN 41003

- **Mounting box:** Minimum 25mm deep

- **Fixing screws:** M3.5 x 25mm and 30mm

- **Plate dimensions:** 88 x 88mm

- **Technical notes:** Refer to euro plate & modules section for combined telephone & data solutions.

Secondary BT telephone



GU7562BBC

Product code	Description	Pack qty
GU7562*BC	Brushed chrome	1
GU7562*PC	Polished chrome	1

Polished chrome white interior



Polished chrome black interior



Brushed chrome white interior



Brushed chrome black interior



TV outlets

Single TV/FM



GU7510BBC

Product code	Description	Pack qty
GU7510*BC	Brushed chrome	1
GU7510*PC	Polished chrome	1

- **Standard of compliance:** BS 3041 (where applicable)
- **Mounting box:** 25mm deep
- **Fixing screws:** M3.5 x 25mm and 30mm
- **Plate dimensions:** 88 x 88mm
- **Technical notes:** Products are direct connection and not suitable for common connection

Euro modular plates & modules

1 gang euro plate, 1 module 25 x 50mm



GU8550PC

Product code	Description	Pack qty
GU8550BC	Brushed chrome	1
GU8550PC	Polished chrome	1

- **Mounting box:** Refer to module for appropriate mounting box depth
- **Plate dimensions:** 88 x 88mm (1 gang)
88 x 148mm (2 gang)
- **Technical notes:** Mounting grid supplied with euro plate.
- Euro modules plates compatible with Schneider Electric euro modules.
- **Note:** modules from other suppliers may not be compatible, it is advised to check suitability.

1 gang euro plate, 2 module 50 x 50mm



GU8560PC

Product code	Description	Pack qty
GU8560BC	Brushed chrome	1
GU8560PC	Polished chrome	1

2 gang euro plate, 4 module 100 x 50mm



GU8580BC

Product code	Description	Pack qty
GU8580BC	Brushed chrome	1
GU8580PC	Polished chrome	1

Polished chrome white interior



Polished chrome black interior



Brushed chrome white interior



Brushed chrome black interior



Euro modular plates & modules continued

25 x 50mm euro modules



Product code	Description	Pack qty
GUE7011*	Single IEC coax (female)	1
GUE7012*	25 x 50mm euro modules IEC coax (male)	1
GUE7030*	Single F type sat	1
GUE7061*	BT master telephone	1
GUE7062*K	BT secondary telephone	1
GUE7071*	RJ45 CAT5e (not screened)	1
GUE7072*	RJ45 CAT6 (not screened)	1
GUE7073*	Single USB charger 1A 5Vdc	1
GUE7051*	RJ11 modem	1
GUE7075*	VGA	1
GUE7091*	LexCom Performance outlet	8
GUE7000*	2 x Phono socket	1
GUE7001*	25 x 50mm euro 2 x Loudspeaker socket	1
GUE8010*	25 x 50mm euro Blank module	5

50 x 50mm euro modules



Product code	Description	Pack qty
GUE7010*	TV/FM diplexer	1
GUE7040*	TV/Sat diplexer	1
GUE7074*	Twin USB charger 2 x 1A 5Vdc	1
GUE7081*	TV/FM/Sat triplexer	1
GUE7082*	TV/FM/Sat1/Sat2 quadplexer	1
GUE7020*	HDMI	1
GGBLGUE7078*	American power socket	1
GUE7076*	Brush outlet	1
GUE7077*	5A round pin socket	1
GGBGUE7079*	European socket	1

• **MTO products for projects only, leadtime to be confirmed at time of ordering**

Blank plates & accessories

1 gang



GU8510BC

Product code	Description	Pack qty
GU8510BC	Brushed chrome	1
GU8510PC	Polished chrome	1

• **Standard of compliance:** BS 5733
 • **Fixing screws:** M3.5 x 25mm and 30mm
 • **Plate dimensions:** 88 x 88mm (1 gang), 88 x 148mm (2 gang)

2 gang



GU8520BC

Product code	Description	Pack qty
GU8520BC	Brushed chrome	1
GU8520PC	Polished chrome	1
3746130	M3.5 x 25mm raised head machine screws	100
USCREW50SS	M3.5 x 50mm screws	100

Grid plates

1 gang 88 x 88mm



GUGL01BC

Product code	Description	Pack qty
GUGL01BC	Brushed chrome	1
GUGL01PC	Polished chrome	1
GBG01	76 x 76 x 42mm back box	1

2 gang 88 x 88mm



GUGL02BC

Product code	Description	Pack qty
GUGL02BC	Brushed chrome	1
GUGL02PC	Polished chrome	1
GBG01	76 x 76 x 42mm back box	1

3 gang 88 x 148mm



GUGL03BC

Product code	Description	Pack qty
GUGL03BC	Brushed chrome	1
GUGL03PC	Polished chrome	1
GBG02	136 x 76 x 42mm back box	1

4 gang 88 x 148mm



GUGL04BC

Product code	Description	Pack qty
GUGL04BC	Brushed chrome	1
GUGL04PC	Polished chrome	1
GBG02	136 x 76 x 42mm back box	1

6 gang 156 x 156mm



GUGL06BC

Product code	Description	Pack qty
GUGL06BC	Brushed chrome	1
GUGL06PC	Polished chrome	1
GBG03	136 x 136 x 42mm back box	1

8 gang 156 x 156mm



GUGL08BC

Product code	Description	Pack qty
GUGL08BC	Brushed chrome	1
GUGL08PC	Polished chrome	1
GBG03	136 x 136 x 42mm back box	1

- **Mounting box:**
42mm deep
- **Technical notes:**
All grid plates are supplied with the appropriate number of mounting frames.

Polished chrome
white interior



Polished chrome
black interior



Brushed chrome
white interior



Brushed chrome
black interior



Customisable switch grid modules

10AX metal switch module components (white or black surrounds)



GUG102MB GUG101MW

Product code	Description	Pack qty
GUG101M*	10AX 1 way SP	1
GUG102M*	10AX 2 way SP	1
GUG101M*	10AX intermediate SP	1

20AX metal switch module components (white or black surrounds)



GUG2020MB GUG20DPMW

Product code	Description	Pack qty
GUG201M*	20AX 1 way SP	1
GUG2020M*	20AX 2 way and centre off SP	1
GUG202M*	20AX 2 way SP	1
GUG20DPM*	20AX DP	1

- **Standard of compliance:** BS EN 60669-1
- **Mounting box:** 42mm deep
- **Technical notes:** 10AX & 20AX metal switch module components available in black or white.
- Clear terminal marking printed onto grey switch module component back mouldings ensures easy identification.
- Pre-printed rocker caps
- Easy assembly

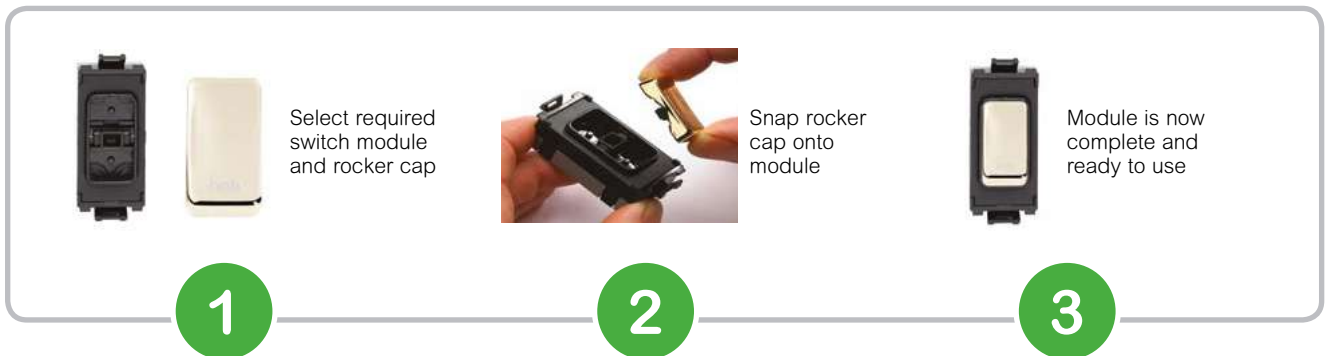

Plain and printed rocker caps for component modules



	Stainless Steel	Mirror Steel	Painted White	Painted Black	Pack qty
Plain rocker cap	GUGRSS	GUGRMS	GUGRPW	GUGRBLK	6
Rocker cap printed boiler	GUGRBOSS	GUGRBOMS	GUGRBOPW	GUGRBOBLK	6
Rocker cap printed cooker hood	GUGRCHSS	GUGRCHMS	GUGRCHPW	GUGRCHBLK	6
Rocker cap printed dish washer	GUGRDWSS	GUGRDWMS	GUGRDWPW	GUGRDWBLK	6
Rocker cap printed extractor fan	GUGREFSS	GUGREFMS	GUGREFPW	GUGREFBLK	6
Rocker cap printed fridge	GUGRFRSS	GUGRFRMS	GUGRFRPW	GUGRFRBLK	6
Rocker cap printed fan	GUGRFASS	GUGRFAMS	GUGRFAPW	GUGRFABLK	6
Rocker cap printed freezer	GUGRFZSS	GUGRFZMS	GUGRFZPW	GUGRFZBLK	6
Rocker cap printed fridge/freezer	GUGRFRFZSS	GUGRFRFZMS	GUGRFRFZPW	GUGRFRFZBLK	6
Rocker cap printed hob	GUGRHOSS	GUGRHOMS	GUGRHOPW	GUGRHOBLK	6
Rocker cap printed heater	GUGRHESS	GUGRHEMS	GUGRHEPW	GUGRHEBLK	6
Rocker cap printed microwave	GUGRMWSS	GUGRMWMS	GUGRMWPW	GUGRMWBLK	6
Rocker cap printed oven	GUGROVSS	GUGROVMS	GUGROVPW	GUGROVBLK	6
Rocker cap printed tumble dryer	GUGRTDSS	GUGRTDMS	GUGRTDPW	GUGRTDBLK	6
Rocker cap printed washer dryer	GUGRWDYSS	GUGRWDYMS	GUGRWDYPW	GUGRWDYBLK	6
Rocker cap printed waste disposal	GUGRWDSS	GUGRWDMS	GUGRWDPW	GUGRWDBLK	6
Rocker cap printed washing machine	GUGRWMSS	GUGRWMMS	GUGRWPW	GUGRWMBLK	6

Retractive & toggle switch grid modules

6A 2 way retractive and centre off



GUG202OCBLK

Product code	Description	Pack qty
GUG202OC*MS	Mirror Steel	1
GUG202OCBLK	Painted black with black interior	1
GUG202OCWPW	Painted white with white interior	1

- **Standard of compliance:** BS EN 60669-1
- **Mounting box:** 42mm deep
- **Technical notes:** Mirror steel used for polished chrome grid modules.

10A 2 way retractive single-pole



GUG102RBLK

Product code	Description	Pack qty
GUG102R*MS	Mirror Steel	1
GUG102RBLK	Painted black with black interior	1
GUG102RWPW	Painted white with white interior	1

Retractive & toggle switch grid modules continued

10AX 2 way single-pole toggle



GUG102TWPW

Product code	Description	Pack qty
GUG102T*MS	Mirror Steel	1
GUG102TWPW	Painted white with white interior	1

10AX intermediate toggle



GUG101TWPW

Product code	Description	Pack qty
GUG101T*MS	Mirror Steel	1
GUG101TWPW	Painted white with white interior	1

Key switch grid modules

20AX 1 way double-pole key operated



GUG20DPKBLK

Product code	Description	Pack qty
GUG20DPK*MS	Mirror Steel	1
GUG20DPKBLK	Painted black with black interior	1
GUG20DPKWPW	Painted white with white interior	1

- **Standard of compliance:**
BS EN 60669-1
- **Mounting box:**
42mm deep
- **Technical notes:**
Mirror steel used for polished chrome grid modules.

20AX 2 way key operated



GUG202KBLK

Product code	Description	Pack qty
GUG202K*MS	Mirror Steel	1
GUG202KBLK	Painted black with black interior	1
GUG202KWPW	Painted white with white interior	1

20AX 2 way key operated printed red TEST EMG LTG



GUG202KELBLK

Product code	Description	Pack qty
GUG202KEL*MS	Mirror Steel	1
GUG202KELBLK	Painted black with black interior	1
GUG202KELWPW	Painted white with white interior	1

Telephone grid modules

BT master telephone



GUGTEMLBLK

Product code	Description	Pack qty
GUGTELM*MS	Mirror Steel	1
GUGTEMLBLK	Painted black with black interior	1
GUGTELMWPW	Painted white with white interior	1

- **Standard of compliance:** BS EN 3041 (where applicable)
- **Mounting box:** 42mm deep
- **Technical notes:** Mirror steel used for polished chrome grid modules.

BT secondary telephone



GUGTELSBLK

Product code	Description	Pack qty
GUGTELS*MS	Mirror Steel	1
GUGTELSBLK	Painted black with black interior	1
GUGTELSWPW	Painted white with white interior	1

RJ11 telephone



GUGRJ11BLK

Product code	Description	Pack qty
GUGRJ11*MS	Mirror Steel	1
GUGRJ11BLK	Painted black with black interior	1
GUGRJ11WPW	Painted white with white interior	1

Data & TV grid modules

RJ45 CAT5e



GUGRJ45BLK

Product code	Description	Pack qty
GUGRJ45*MS	Mirror Steel	1
GUGRJ45BLK	Painted black with black interior	1
GUGRJ45WPW	Painted white with white interior	1

- **Standard of compliance:** BS EN 3041 (where applicable)
- **Mounting box:** 42mm deep
- **Technical notes:** Mirror steel used for polished chrome grid modules.

Direct coaxial TV



GUGCOBLK

Product code	Description	Pack qty
GUGCO*MS	Mirror Steel	1
GUGCOBLK	Painted black with black interior	1
GUGCOWPW	Painted white with white interior	1

F type satellite



GUGSATWPW

Product code	Description	Pack qty
GUGSAT*MS	Mirror Steel	1
GUGSATWPW	Painted white with white interior	1

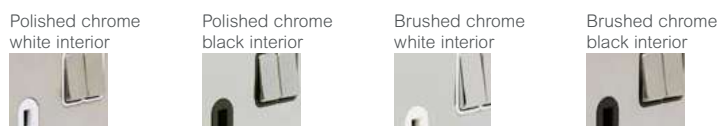

Electronic dimmer grid modules

300W/VA universal multiway touch dimmer module



GUGEMDIMWPW16

Product code	Description	Pack qty
GUGEMDIM*MS16	Mirror Steel	1
GUGEMDIMWPW16	Painted white with white interior	1

- **Mounting box:** 42mm deep
- **Technical notes:** Min load 60W/50VA.

Mirror steel used for polished chrome grid modules.

300W/VA universal multiway touch dimmer module with infra red remote option



GUGEMRDIMB16

Product code	Description	Pack qty
GUGEMRDIMB16	Black moulded	1
GUGEMRDIMW16	White moulded	1
GU6000RC1R	1 channel IR remote control	1

- Electronic modules are capable of 2 way or multiway dimming.
- Retractive switch for use with electronic dimmers only.
- Not compatible with moulded grid plates.
- Modules will require derating when used in multi-gang applications.

50mA 2 way & multiway retractive switch module



GUGEMWWPW

Product code	Description	Pack qty
GUGSAT*MS	Mirror Steel	1
GUGSATWPW	Painted white with white interior	1

Fuse carrier, flex outlet & blank grid modules

13A fuse carrier



GUG13FCUBLK

Product code	Description	Pack qty
GUG13FCU*MS	Mirror Steel	1
GUG13FCUBLK	Painted black with black interior	1
GUG13FCUWPW	Painted white with white interior	1

- **Standard of compliance:** BS 1363 (fuse carrier) BS 5733
- **Mounting box:** 42mm deep
- **Technical notes:** Full metal surround on all modules

Modules are completely interchangeable

Mirror steel used for polished chrome grid modules.

Flex outlet up to 10mm ø



GUG16COBLK

Product code	Description	Pack qty
GUG16CO*MS	Mirror Steel	1
GUG16COBLK	Painted black with black interior	1
GUG16COWPW	Painted white with white interior	1

Blank



GUGBB

Product code	Description	Pack qty
GUGB*MS	Mirror Steel	1
GUGBBLK	Painted black with black interior	1
GUGBWPW	Painted white with white interior	1

Indicator modules

White surround



GUGINDWG



GUGINDWR



GUGINDWO

Product code	Description	Pack qty
GUGINDWG	Green indicator	1
GUGINDWR	Red indicator	1
GUGINDWO	Orange indicator	1

- **Standard of compliance:** BS 5733
- **Mounting box:** 42mm deep
- **Technical notes:** 240V

Black surround



GUGINDBG



GUGINDBR



GUGINDBO

Product code	Description	Pack qty
GUGINDBG	Green indicator	1
GUGINDBR	Red indicator	1
GUGINDBO	Orange indicator	1

- **Standard of compliance:** BS 5733
- **Mounting box:** 42mm deep
- **Technical notes:** 240V

Flush galvanised steel boxes

16mm deep



SB161

Product code	Description	Pack qty
SB161	1 gang	20

- **Technical notes:**
Supplied with earth terminal and screw.

Supplied with fixed and adjustable lugs.

Fitted with selection of 20mm knockouts in sides and back.

25mm deep



SB252

Product code	Description	Pack qty
SB251	1 gang	10
SB252	2 gang	10

35mm deep



SB351

Product code	Description	Pack qty
SB351	1 gang	10
SB352	2 gang	5

47mm deep



SB472

Product code	Description	Pack qty
SB471	1 gang	10
SB472	2 gang	4

Ultimate Slimline White Moulded

True to its name, the Ultimate Slimline range offers one of the most slender, elegantly crafted white moulded accessory ranges on the market today.

And this premium design isn't just skin deep – turn the product over to see tailored features that will make installation faster and easier. A vast compliment of Part M, Essential Supply, and wide rocker options will ensure that you are always prepared for the precise needs of your customers.

Elegantly curved rockers for more refined style

With the average home now containing a multitude of smartphones, tablets and other devices, there can often be issues of cable mess and a lack of available plug sockets. Our USB solutions directly help in solving this problem.

Ultra slim construction with minimal back projection for an easy installation onto standard flush mounting boxes (including 16mm)

Consistent styling throughout, as all Slimline products share same profile, from switches to cooker control units

Individually bagged product ensures products are kept in perfect condition right up until installation

Screw cap covers provided to hide fixing screws and create a smoother line. Two sets supplied with all moulded products

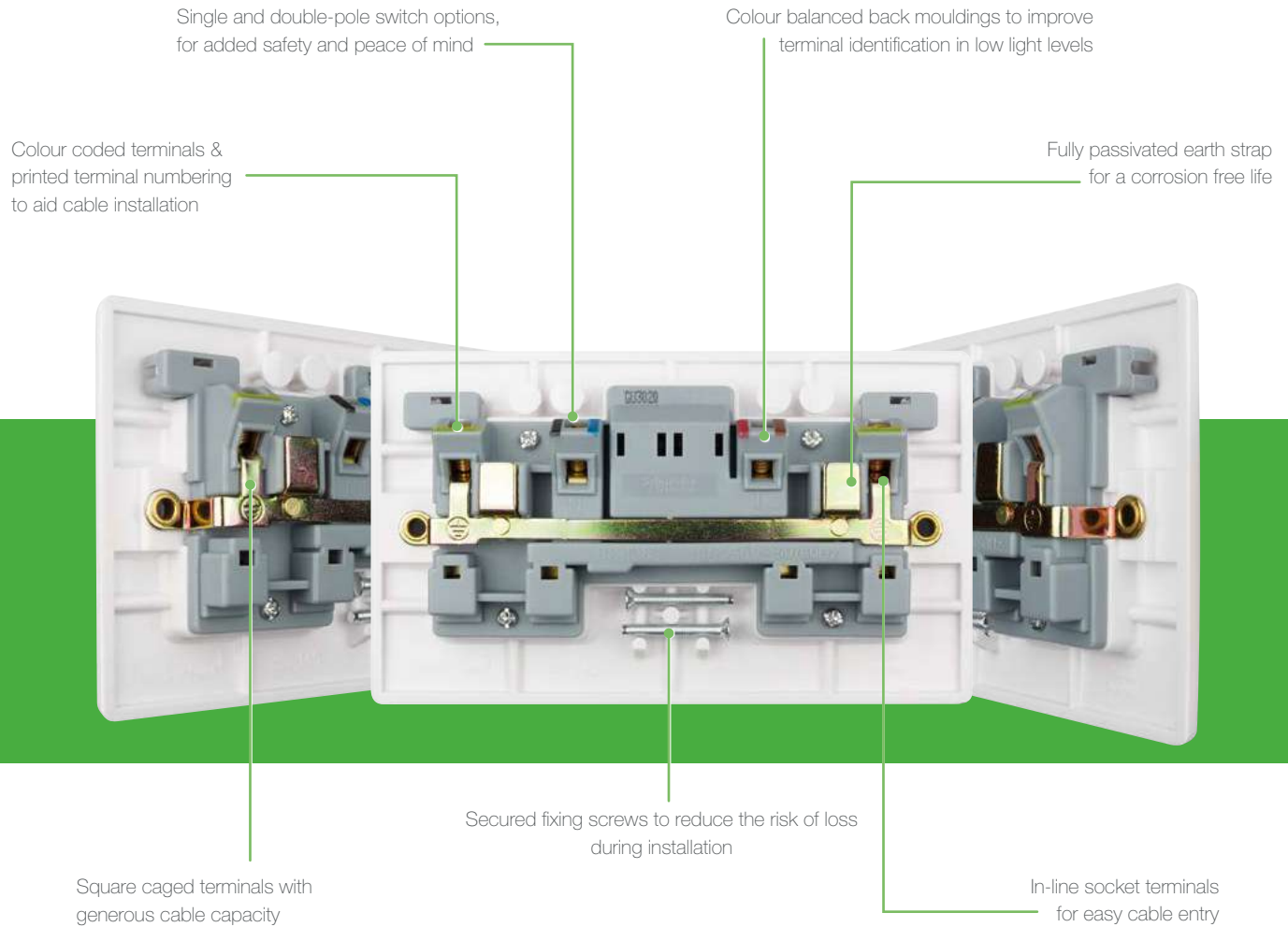

Specification Highlights



LED dimming solutions tested with leading lamp manufacturers and future-proofed switch ratings of 16AX, to satisfy all lighting demands



50A rated plate switches for switching appliances with higher current ratings, such as heaters, cookers and commercial refrigerating units



Twin earth terminals on 2 gang sockets enable installation in areas requiring high integrity earthing



Unique integral locking facility on isolator for enhanced safety



Comprehensive Part M compliant solution including socket outlets with outboard rockers, wide rocker switches, and grey faceplates



Colour coded in-line terminals as well as a colour balanced back moulding makes terminals easily identifiable during installation, particularly in lower light levels

Socket outlets

13A unswitched socket outlets



GU3050



GU3060

Product code	Description	Pack qty
GU3050	1 gang	10
GU3060	2 gang	5
GU3060RD	2 gang - red	5

13A switched socket outlets



GU3011

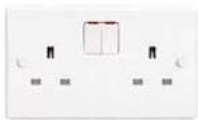

GU3020,
GU3020D

Product code	Description	Pack qty
GU3010	1 gang single-pole	10
GU3011	1 gang single-pole with neon	10
GU3010D	1 gang double-pole	10
GU3010DGY	1 gang double-pole - grey	10
GU3010DRD	1 gang double-pole - red	10
GU3020	2 gang single-pole	5
GU3021	2 gang single-pole with neons	5
GU3020D	2 gang double-pole	5

13A switched with outboard rockers socket outlets



GU3033



GU3030GY



GU3030RD

Product code	Description	Pack qty
GU3030	2 gang double-pole	5
GU3030GY	2 gang double-pole - grey	5
GU3030RD	2 gang double-pole - red	5
GU3031	2 gang double-pole with clean earth	5
GU3033	2 gang double-pole, non-standard with clean earth	5

13A switched with red neon outboard rockers socket outlets



GU3032



GU3034

Product code	Description	Pack qty
GU3032	2 gang double-pole with clean earth	5
GU3034	2 gang double-pole, non-standard with clean earth	5

- **Standard of compliance:**
BS 1363 (13A)
BS 546 (round pin)
- **Mounting box:**
Minimum 25mm deep
- **Fixing screws:**
M3.5 x 30mm
- **Plate dimensions:**
86 x 86mm
(1 gang)
86 x 146mm
(2 gang)



- **Note:** All 2 gang sockets include twin earth terminals as standard, enabling high integrity earthing. To aid flush installation, 35mm steel boxes are recommended.

13A 2 gang switched USB socket



GGBGU30202USBRP

Product code	Description	Pack qty
GGBGU30202USBRP	2 gang SP socket outlets with 2x USB chargers	10

- **Mounting box:**
Minimum 35mm deep

Round pin socket outlets



GU3080



GU3090



GU3091

Product code	Description	Pack qty
GU3070	2A unswitched	10
GU3080	5A unswitched	10
GU3090	15A switched	10
GU3091	15A switched with neon	10

- **Standard of compliance:**
BS 546
- **Mounting box:**
Minimum 25mm deep
- **Fixing screws:**
M3.5 x 30mm
- **Plate dimensions:**
86 x 86mm

Plate switches

16AX 1 gang plate switches



GU1011,
GU1012,
GU1014



GU1012GY,
GU1014GY

Product code	Description	Pack qty
GU1011	1 way	10
GU1012	2 way	10
GU1012GY	2 way - grey	10
GU1014	Intermediate	10
GU1014GY	Intermediate - grey	10

- **Standard of compliance:**
BS EN 60669-1
- **Mounting box:**
16mm deep (1-2 gang)
25mm deep (3-6 gang)
- **Fixing screws:**
M3.5 x 18mm
- **Plate dimensions:**
86 x 86mm (1-3 gang standard rocker)
86 x 146mm (4-6 gang standard rocker)

16A 1 gang retractive plate switches



GU1012RGY



GU1012RP



GU1012RB

Product code	Description	Pack qty
GU1012R	2 way	10
GU1012RGY	2 way - grey	10
GU1012RP	2 way printed with press	10
GU1012RB	2 way printed with a bell symbol	10

16AX multi gang plate switches



GU1022



GU1022GY



GU1032

Product code	Description	Pack qty
GU1022	2 gang 2 way	10
GU1022GY	2 gang 2 way - grey	10
GU1032	3 gang 2 way	10
GU1032GY	3 gang 2 way - grey	10
GU1042	4 gang 2 way	5
GU1062	6 gang 2 way	5



Part M
Comprehensive Part M compliant solution including socket outlets with outboard rockers, wide rocker switches and grey faceplates

Plate switches continued

10A triple pole isolator



GU1013

Product code	Description	Pack qty
GU1013	10A triple pole isolator	10

1 gang wide rocker



GRWH1012,
GRWH1014



GRWH1012GY,
GRWH1014GY

Product code	Description	Pack qty
GRWH1012	16AX 1 gang 2 way	10
GRWH1012GY	16AX 1 gang 2 way - grey	10
GRWH1014	10AX 1 gang intermediate	10
GRWH1014GY	10AX 1 gang intermediate - grey	10

16AX multi gang wide rocker



GRWH1032A



GRWH1022GY

Product code	Description	Pack qty
GRWH1022	2 gang 2 way	10
GRWH1022GY	2 gang 2 way - grey	10
GRWH1032A	3 gang 2 way	10
GRWH1032GY	3 gang 2 way - grey	10

10AX architrave



GU1012A



GU1022A

Product code	Description	Pack qty
GU1012A	1 gang 2 way	10
GU1022A	2 gang 2 way	10

Ceiling pull cords



GPULLGY



GPULLRD

Product code	Description	Pack qty
GPULLGY	1.5m with single bangle - grey	10
GPULLRD	1.5m with twin bangle - red	10

- **Standard of compliance:**
BS EN 60669-1
BS EN 60947-3
(GU1013)
- **Mounting box:**
16mm deep
(GU1013 and architrave)
25mm deep (wide rocker)
- **Fixing screws:**
M3.5 x 18mm
(GU1013 and architrave), M3.5 x 25mm (wide rocker)
- **Plate dimensions:**
86 x 86mm
(GU1013)
- 87 x 87mm (wide rocker)
- 33 x 86mm (1 gang architrave)
- 33 x 148mm (2 gang architrave)
- **Technical notes:**
Ceiling switches are sold separately to GPULLGY & GPULLRD.

Dimmer switches

Mains & low voltage



GU6012C GU6022C

Product code	Description	Pack qty
GU6012C	1 gang 2 way 400W/VA	1
GU6022C	2 gang 2 way 250W/VA	1
GU6032C	3 gang 2 way 250W/VA	1
GU6042C	4 gang 2 way 250W/VA	1

LED



GU6032L



GU6042L

Product code	Description	Pack qty
GU6012L	1 gang 2 way 100W/VA	1
GU6022L	2 gang 2 way 100W/VA	1
GU6032L	3 gang 2 way 75W/VA	1
GU6042L	4 gang 2 way 75W/VA	1

- **Standard of compliance:** BS EN 60669-2-1
- **Mounting box:** 25mm deep
- **Fixing screws:** M3.5 x 30mm
- **Plate dimensions:** 86 x 86mm (1 gang)
86 x 146mm (2 gang)
- Leading edge control

- **Standard of compliance:** BS EN 60669-2-1
- **Mounting box:** 25mm deep
- **Fixing screws:** M3.5 x 30mm
- **Plate dimensions:** 86 x 86mm (1 gang)
86 x 146mm (2 gang)
- Trailing edge control
- **Note:** 1 and 2 gang dimmer switches include spacing frame for mounting in plaster depth 16mm boxes"

Control switches & flex outlet plates

20AX DP 1 gang switched



GU2010 GU2010GY



GU2011HT

Product code	Description	Pack qty
GU2010	20AX DP 1 gang switched	10
GU2010GY	20AX DP 1 gang switched - grey	10
GU2010HT	20AX DP 1 gang switched engraved heater	10
GU2010OV	20AX DP 1 gang switched engraved oven	10
GU2011	20AX DP 1 gang switched with neon	10
GU2011HT	20AX DP 1 gang switched with neon engraved heater	10
GU2011OV	20AX DP 1 gang switched with neon engraved oven	10
GU2011TR	20AX DP 1 gang switched with neon engraved towel rail	10

- **Standard of compliance:** BS EN 60669-1
- **Mounting box:** 25mm deep
- **Fixing screws:** M3.5 x 30mm
- **Plate dimensions:** 86 x 86mm

20AX DP 1 gang switched with flex outlet



GU2013TR GU2014



GU2014WH

Product code	Description	Pack qty
GU2013	20AX DP 1 gang switched with flex outlet	10
GU2013HT	20AX DP 1 gang switched with flex outlet engraved heater	10
GU2013TR	20AX DP 1 gang switched with flex outlet engraved towel rail	10
GU2014	20AX DP 1 gang switched with flex outlet and neon	10
GU2014HT	20AX DP 1 gang switched with flex outlet and neon engraved heater	10
GU2014WH	20AX DP 1 gang switched with flex outlet and neon engraved water heater	10

Control switches & flex outlet plates continued

32A DP 1 gang switched



GU4031

Product code	Description	Pack qty
GU4031	32A DP 1 gang switched with neon	10

- **Standard of compliance:** BS EN 60669-1 (GU4031) BS 5733 (flex outlet plates)
- **Mounting box:** 25mm deep
- **Fixing screws:** M3.5 x 30mm
- **Plate dimensions:** 86 x 86mm

Flex outlet plates



GU2033



GU2003

Product code	Description	Pack qty
GU2033	25A side entry	10
GU2003	20A front entry	10

Fused connection units

13A unswitched



GU5000



GU5000MW



GU5000RD



GU5003TR

Product code	Description	Pack qty
GU5000	13A unswitched	10
GU5000RD	13A unswitched - red	10
GU5000HT	13A unswitched engraved heater	10
GU5000MW	13A unswitched engraved microwave	10
GU5000SS	13A unswitched engraved security	10
GU5000TR	13A unswitched engraved towel rail	10
GU5000TD	13A unswitched engraved tumble dryer	10
GU5000WD	13A unswitched engraved waste disposal	10
GU5001	13A unswitched with neon	10
GU5003	13A unswitched with flex outlet	10
GU5003TR	13A unswitched with flex outlet engraved towel rail	10
GU5004	13A unswitched with neon & flex outlet	10

- **Standard of compliance:** BS 1363
- **Mounting box:** 25mm deep
- **Fixing screws:** M3.5 x 30mm
- **Plate dimensions:** 86 x 86mm

3A unswitched



GU50003



GU50033

Product code	Description	Pack qty
GU50003	3A unswitched	10
GU50033	3A unswitched with flex outlet	10

- **Standard of compliance:** BS 1363
- **Mounting box:** 25mm deep
- **Fixing screws:** M3.5 x 30mm
- **Plate dimensions:** 86 x 86mm

Fused connection units continued

13A DP switched



GU5010



GU5010GY



GU5010CH

Product code	Description	Pack qty
GU5010	13A DP switched	10
GU5010GY	13A DP switched - grey	10
GU5010RD	13A DP switched - red	10
GU5010BO	13A DP switched engraved boiler	10
GU5010CH	13A DP switched engraved cooker hood	10
GU5010DW	13A DP switched engraved dish washer	10
GU5010EF	13A DP switched engraved extractor fan	10
GU5010FA	13A DP switched engraved fan	10
GU5010FZ	13A DP switched engraved freezer	10
GU5010FR	13A DP switched engraved fridge	10
GU5010FFZ	13A DP switched engraved fridge/freezer	10
GU5010HO	13A DP switched engraved hob	10
GU5010HT	13A DP switched engraved heater	10
GU5010MW	13A DP switched engraved microwave	10
GU5010TD	13A DP switched engraved tumble dryer	10
GU5010WD	13A DP switched engraved waste disposal	10
GU5010WM	13A DP switched engraved washing machine	10

- **Standard of compliance:** BS 1363
- **Mounting box:** 25mm deep
- **Fixing screws:** M3.5 x 30mm
- **Plate dimensions:** 86 x 86mm

13A DP switched with neon



GU5011



GU5011GY



GU5011FFZ

Product code	Description	Pack qty
GU5011	13A DP switched with neon	10
GU5011GY	13A DP switched with neon - grey	10
GU5011BO	13A DP switched with neon engraved boiler	10
GU5011CH	13A DP switched with neon engraved cooker hood	10
GU5011DW	13A DP switched with neon engraved dish washer	10
GU5011EF	13A DP switched with neon engraved extractor fan	10
GU5011FA	13A DP switched with neon engraved fan	10
GU5011FZ	13A DP switched with neon engraved freezer	10
GU5011FR	13A DP switched with neon engraved fridge	10
GU5011FFZ	13A DP switched with neon engraved fridge/freezer	10
GU5011HO	13A DP switched with neon engraved hob	10
GU5011HT	13A DP switched with neon engraved heater	10
GU5011MW	13A DP switched with neon engraved microwave	10
GU5011TD	13A DP switched with neon engraved tumble dryer	10
GU5011WD	13A DP switched with neon engraved waste disposal	10
GU5011WM	13A DP switched with neon engraved washing machine	10

- **Standard of compliance:** BS 1363
- **Mounting box:** 25mm deep
- **Fixing screws:** M3.5 x 30mm
- **Plate dimensions:** 86 x 86mm

13A DP switched with flex outlet



GU5013



GU5014

Product code	Description	Pack qty
GU5013	13A DP switched with flex outlet	10
GU5014	13A DP switched with flex outlet and neon	10

- **Standard of compliance:** BS 1363
- **Mounting box:** 25mm deep
- **Fixing screws:** M3.5 x 30mm
- **Plate dimensions:** 86 x 86mm

High current switches

50A DP switches



GU4011



GU4020

Product code	Description	Pack qty
GU4010	50A 1 gang DP switch	10
GU4011	50A 1 gang DP switch with neon	10
GU4020	50A 2 gang DP switch	5
GU4020GY	50A 2 gang DP switch - grey	5
GU4021	50A 2 gang DP switch with neon	5

- **Standard of compliance:** BS EN 60669-1 (50A DP switches) BS 4177 (cooker control units)
- **Mounting box:** 47mm deep
- **Fixing screws:** M3.5 x 30mm
- **Plate dimensions:** 86 x 86mm (1 gang) 146 x 86mm (2 gang)

45A cooker control unit with 13A switched socket



GU4001

Product code	Description	Pack qty
GU4000	45A cooker control unit with 13A switched socket	5
GU4000GY	45A cooker control unit with 13A switched socket grey	5
GU4001	45A cooker control unit with 13A switched socket with neons	5

Cooker connection unit



GU4050

Product code	Description	Pack qty
GU4050	Cooker connection unit	10

Shaver socket

115/230V dual voltage



GU7090

Product code	Description	Pack qty
GU7090	115/230V dual voltage	1
GU7090GY	115/230V dual voltage grey	1

- **Standard of compliance:** BS EN 61558-2-5
- **Mounting box:** 47mm deep
- **Fixing screws:** M3.5 x 30mm
- **Plate dimensions:** 146 x 86mm (2 gang)

Telephone outlets

Single outlet



GU7051



GU7061, GU7062

Product code	Description	Pack qty
GU7051	RJ11	10
GU7061	BT master	10
GU7062	BT secondary	10

- **Standard of compliance:** BS EN 41003
- **Mounting box:** 25mm deep
- **Fixing screws:** M3.5 x 30mm
- **Plate dimensions:** 86 x 86mm

Data outlets

RJ45 CAT5e outlets



GU7071



GU7072

Product code	Description	Pack qty
GU7071	Single	10
GU7072	Twin	10

- **Standard of compliance:** BS EN 41003
- **Mounting box:** 25mm deep (GU7071)
35mm deep (GU7072 and GU7074)
- **Fixing screws:** M3.5 x 30mm
- **Plate dimensions:** 86 x 86mm (single and twin)
86 x 146mm (quad)

TV outlets

Coaxial sockets



GU7010



GU7020



GU7030

Product code	Description	Pack qty
GU7010	Single TV/FM	10
GU7020	Twin TV/FM	10
GU7030	Single satellite	10
GU7040	Twin satellite	5

- **Standard of compliance:** BS 3041 (where applicable)
- **Mounting box:** 25mm deep
- **Fixing screws:** M3.5 x 30mm
- **Plate dimensions:** 86 x 86mm

Screened coaxial sockets



GU7021



GU7081

Product code	Description	Pack qty
GU7021	Diplex TV/F	10
GU7081	Triplex TV/FM/SAT	10

Blank plates & accessories

Blank plates & accessories



GU8010



GU8020

Product code	Description	Pack qty
GU8010	1 gang blank plate	10
GU8020	2 gang blank plate	10
GUMSCO	White moulded screw cap covers	100
USCREW50SS	M3.5 x 50mm screws	100
3746130	M3.5 x 25mm raised head machine screws	100

- **Standard of compliance:** BS EN 5733
- **Fixing screws:** M3.5 x 30mm
- **Plate dimensions:** 86 x 86mm (1 gang)
86 x 146mm (2 gang)

Grid plates

88 x 88mm



Product code	Description	Pack qty
GUG01G	1 gang 88 x 88mm	1
GUG01GGY	1 gang 88 x 88mm - grey	1
GUG02G	2 gang 88 x 88mm	1
GUG02GGY	2 gang 88 x 88mm - grey	1
GBG01	76 x 76 x 42mm flush mounted back box	1

88 x 148mm



Product code	Description	Pack qty
GUG03G	3 gang 88 x 148mm	1
GUG03GGY	3 gang 88 x 148mm - grey	1
GUG04G	4 gang 88 x 148mm	1
GUG04GGY	4 gang 88 x 148mm - grey	1
GBG02	136 x 76 x 42mm flush mounted back box	1

156 x 156mm

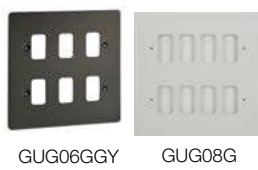

Product code	Description	Pack qty
GUG06G	6 gang 156 x 156mm	1
GUG06GGY	6 gang 156 x 156mm - grey	1
GUG08G	8 gang 156 x 156mm	1
GUG08GGY	8 gang 156 x 156mm - grey	1
GBG03	136 x 136 x 42mm flush mounted back box	1

216 x 156mm

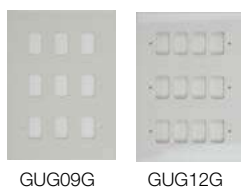

Product code	Description	Pack qty
GUG09G	9 gang 216 x 156mm	1
GUG12G	12 gang 216 x 156mm	1
GBG04F	193 x 133 x 42mm flush mounted back box	1

398 x 156mm

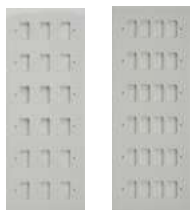

GUG18G GUG24G

Product code	Description	Pack qty
GUG18G	18 gang 398 x 156mm	1
GUG24G	24 gang 398 x 156mm	1
GBG06F	374 x 133 x 42mm flush mounted back box	1

White moulded grid modules

Switch modules



Switch modules



GUG102W

Product code	Description	Pack qty
GUG101W	10AX 1 way switch module	1
GUG102W	10AX 2 way switch module	1
GUG10IW	10AX intermediate switch module	1
GUG201W	20AX 1 way switch module	1
GUG202W	20AX 2 way switch module	1
GUG20DPW	20AX DP switch module	1

- **Standard of compliance:**
BS EN 60669-1

20AX DP printed switch modules



GUG20DPMWW



GUG20DPHTW



GUG20DPHOW

Product code	Description	Pack qty
GUG20DPMWW	20AX DP switch module printed microwave	1
GUG20DPCHW	20AX DP switch module printed cooker hood	1
GUG20DPDWW	20AX DP switch module printed dishwasher	1
GUG20DPFZW	20AX DP switch module printed freezer	1
GUG20DPWMW	20AX DP switch module printed washing machine	1
GUG20DPTDW	20AX DP switch module printed tumble dryer	1
GUG20DPHTW	20AX DP switch module printed heater	1
GUG20DPWDYW	20AX DP switch module printed washer dryer	1
GUG20DPOVW	20AX DP switch module printed oven	1
GUG20DPBOW	20AX DP switch module printed boiler	1
GUG20DPWDW	20AX DP switch module printed waste disposal	1
GUG20DPEFW	20AX DP switch module printed extractor fan	1
GUG20DPFAW	20AX DP switch module printed fan	1
GUG20DPFFZW	20AX DP switch module printed fridge freezer	1
GUG20DPFRW	20AX DP switch module printed fridge	1
GUG20DPHOW	20AX DP switch module printed hob	1

White moulded grid modules continued

On/Off Retractive switch modules



GUG202OCW,
GUG102RW,
GUG2020W

Product code	Description	Pack qty
GUG202OCW	10AX 2 way & centre off retractive switch module	1
GUG102RW	10A 2 way retractive switch module	1
GUG2020W	20AX 2 way on & off switch module	1

• **Standard of compliance:**
BS EN 60669-1

Blank & indicator modules



GUGBW



GUGINDWG



GUGINDWO

Product code	Description	Pack qty
GUGBW	Blank module	1
GUGINDWG	Green indicator module	1
GUGINDWR	Red indicator module	1
GUGINDWO	Orange indicator module	1

• **Standard of compliance:**
BS EN 60669-1
(blank module)
BS 5733
(indicator modules)

White painted metal grid modules

Key switch modules



GUG20DPKWPW, GUG202KELWPW
GUG202KWPW

Product code	Description	Pack qty
GUG20DPKWPW	20AX DP	1
GUG20DPKELWPW	20AX DP printed TEST EMG LTG	1
GUG202KWPW	20AX 2 way	1
GUG202KELWPW	20AX 2 way printed TEST EMG LTG	1

• **Standard of compliance:**
BS EN 60669-1

Communication modules



GUGTELMWPW, GUGTELSWPW
GUGRJ45WPW



GUGCOWPW

Product code	Description	Pack qty
GUGTELMWPW	BT master	1
GUGTELSWPW	BT secondary	1
GUGRJ11WPW	RJ11	1
GUGRJ45WPW	RJ45 CAT5e	1
GUGCOWPW	TV/FM coaxial	1
GUGSATWPW	Satellite	1

• **Standard of compliance:**
BS EN 41003
BS EN 3041
(where applicable)

Fused connection unit & flex outlet



GUG13FCUWPW GUG16COWPW

Product code	Description	Pack qty
GUG13FCUWPW	13A fused connection unit	1
GUG16COWPW	Flex outlet (10mm diameter)	1

Euro modular plates & modules

Euro plates



GU8060



GU8080

Product code	Description	Pack qty
GU8050	1 gang 1 module	10
GU8050GY	1 gang 1 module - grey	1
GU8060	1 gang 2 module	10
GU8060GY	1 gang 2 module - grey	1
GU8080	2 gang 4 module	5
GU8080GY	2 gang 4 module - grey	1

- **Dimensions:** 86 x 86mm (1-2 module), 86 x 146mm (4 module)
- Refer to module for appropriate mounting box depth
- Euro modules plates compatible with Schneider Electric euro modules.
- **Note:** modules from other suppliers may not be compatible, it is advised to check suitability.

25 x 50mm euro modules



GUE7011W



GUE7061W



GUE7071W

Product code	Description	Pack qty
GUE7011W	Single IEC coax (female)	1
GUE7012W	Single IEC coax (male)	1
GUE7030W	Single F type sat	1
GUE7061W	BT master telephone	1
GUE7062WK	BT secondary telephone	1
GUE7071W	RJ45 CAT5e (not screened)	1
GUE7072W	RJ45 CAT6 (not screened)	1
GUE7073W	Single USB charger 1A 5Vdc	1
GUE7051W	RJ11 modem	1
GUE7075W	VGA	1
GUE7091W	LexCom Performance outlet	8
GUE7000W	2 x Phono socket	1
GUE7001W	2 x Loudspeaker socket	1
GUE8010W	Blank module	5

- **Dimension:** 25 x 50mm
- **Mounting Box:** 25mm deep

50 x 50mm euro modules



GUE7010W



GUE7081W



GUE7020W

Product code	Description	Pack qty
GUE7010W	TV/FM diplexer	1
GUE7040W	TV/Sat diplexer	1
GUE7074W	Twin USB charger 2 x 1A 5Vdc	1
GUE7081W	TV/FM/Sat triplexer	1
GUE7082W	TV/FM/Sat1/Sat2 quadplexer	1
GUE7020W	HDMI	1
GGBLGUE7078*	American power socket	1
GUE7076*	Brush outlet	1
GUE7077*	5A round pin socket	1
GGBGUE7079*	European socket	1

- **Dimension:** 50 x 50mm
- **Mounting Box:** 25mm deep
- MTO products for projects only, leadtime to be confirmed at time of ordering

Surface pattresses

1 gang



GU9116

Product code	Description	Pack qty
GU9116	1 gang 16mm	10
GU9125	1 gang 25mm	10
GU9135	1 gang 35mm	10
GU9147	1 gang 47mm	10

- **Standard of compliance:** BS 5733
- **Technical notes:** All supplied complete with earth terminals.

2 gang



GU9D25



GU9235

Product code	Description	Pack qty
GU9225	2 gang 25mm	5
GU9D25	2 gang Dual 25mm	5
GU9235	2 gang 35mm	5
GU9247	2 gang 47mm	5

- **Standard of compliance:** BS 5733
- **Technical notes:** All supplied complete with earth terminals.

Architrave



GPAT1G16A

Product code	Description	Pack qty
GPAT1G16A	Architrave 1 gang 16mm	10
GPAT2G16A	Architrave 2 gang 16mm	10

- **Standard of compliance:** BS 5733
- **Technical notes:** All supplied complete with earth terminals.

Flush galvanised steel boxes

16mm deep



SB161

Product code	Description	Pack qty
SB161	1 gang	20

25mm deep



SB252

Product code	Description	Pack qty
SB251	1 gang	10
SB252	2 gang	10

35mm deep



SB351

Product code	Description	Pack qty
SB351	1 gang	10
SB352	2 gang	5

47mm deep



SB472

Product code	Description	Pack qty
SB471	1 gang	10
SB472	2 gang	4

- **Standard of compliance:** BS 4662

- **Technical notes:** Supplied with earth terminal and screw.

Supplied with fixed and adjustable lugs.

Fitted with selection of 20mm knockouts in sides and back.



Lisse Screwless Deco



Curves in all the right places...

Now in an elegant decorative finish.

The smooth, modern lines of Lisse Screwless Deco offer an understated elegance to compliment today's interiors.

Whatever your taste, you can express your personal sense of style in the home down to the finest detail through the comprehensive range of finishes Lisse Screwless Deco has to offer.



- Ideally suited for new construction and refurbishment projects
- Future-proofed to cater for the latest demands in consumer technology
- Painting and Decorating made easy by the unique Screwless design and clipping system
- Cleverly designed to ensure that product ordering is simple and efficient, with many time and space saving solutions
- Crafted with your customer in mind, adding bespoke solutions to make a lasting impact

Simple by design for home and business

Removable screwless cover and reliable clip-in system make Painting & Decorating easier

Insert around the rocker enhances the rocker shape

Gently rounded metal rockers to compliment the curved profile

LED power indicator which provides a robust, efficient and long lasting solution

Large plate footprint provides extra strength and reduces the need for additional decorating

Available in a range of 4 stocked and 3 made-to-order metal finishes

GGBL3020DBSS

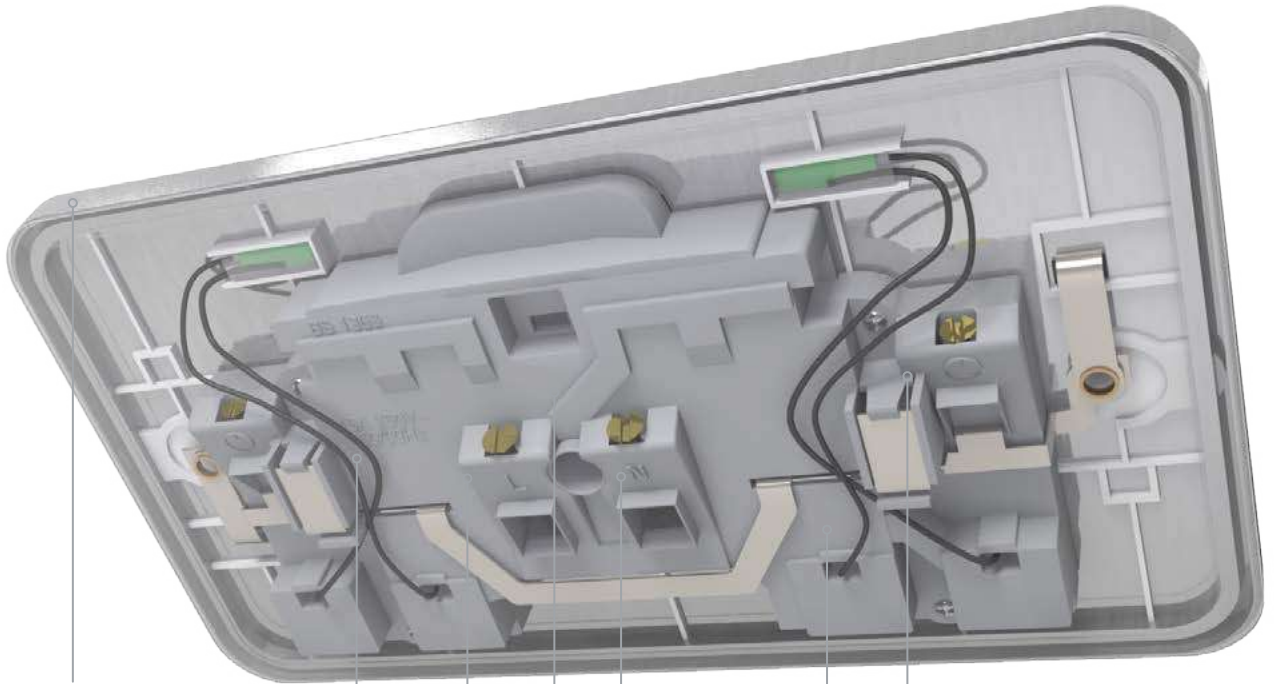

7mm raised edge profile offers easy installation for new builds and retrofits

Angled terminals for easier access

Backed out and captive screw terminals to allow for positive drive and speed of installation

Minimum back projection frees up space in the back box for cabling

Twin earth terminals on all 2 gang 13A socket outlets, for high integrity earthing

Light grey back moulding colour for easier terminal identification

Cable markings on all products with a moulded template to check the wire length

Easy to understand part codes

Simple ideas...

Provide your customers the style and performance that they are looking for, whilst enjoying easier ordering with the Lisse Screwless Deco range. Part codes follow a standard, straight forward methodology to save you time.

...with a simple part code structure

- | | | | |
|----|-------------------------------------|----|-----------------|
| 10 | Plate switches | SS | Stainless Steel |
| 20 | 20AX switches & flex outlets | PC | Polished Chrome |
| 30 | Sockets | MB | Mocha Bronze |
| 40 | 50A switches & 45A control units | SB | Satin Brass |
| 50 | Fused connection units | PB | Polished Brass |
| 60 | Dimmers | PW | Painted White |
| 70 | Shaver sockets & data communication | LC | Light Copper |
| 80 | Blank plates | | |

- B Black
W White

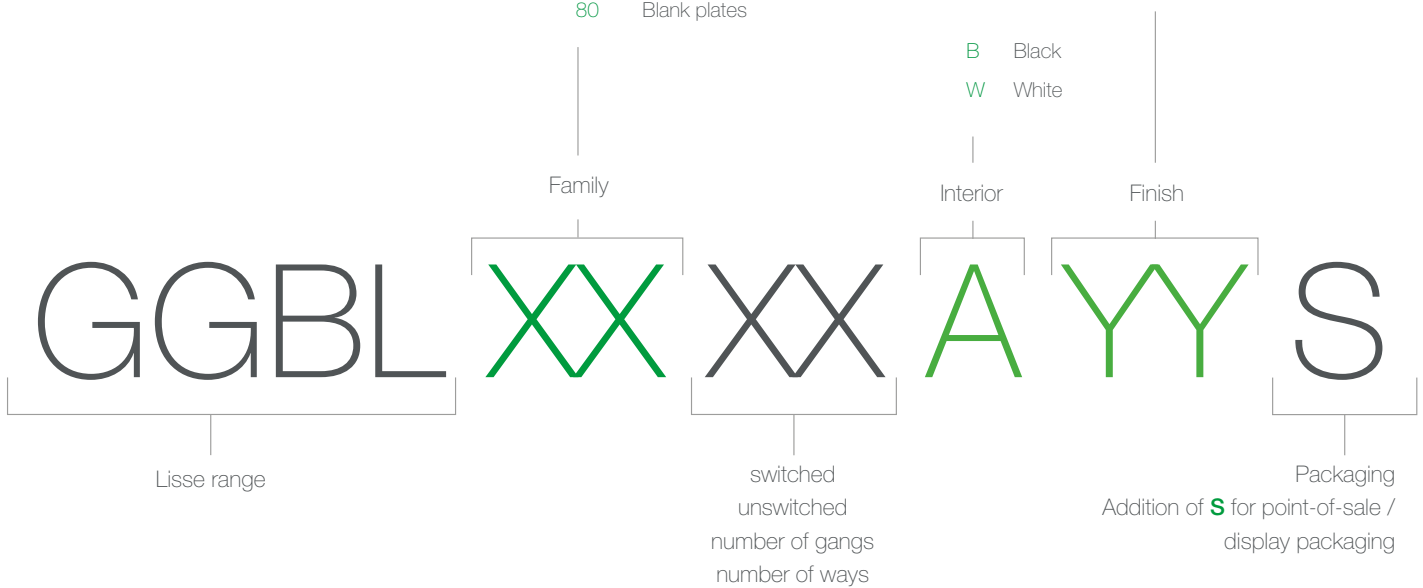

Clear, useful packaging

Lisse packaging is offered in both point-of-sale and wholesale options, depending on your needs. Each option offers clear product information and descriptions, helping to minimise errors when preparing orders.



Point of Sale / shelf-ready box and display packaging

- Clear descriptions, highlights and pictograms to inform and aid purchasing decisions
- Shelf-ready box as a ready-to-sell merchandised unit
- Product reference easily identifiable
- Unobstructed view of front and back of product
- Simply add **S** suffix to wholesale reference









Wholesale packaging

- Optimal dimensions for standard shelves to optimise use of shelf space
- Securely packaged to prevent movement inside the box
- Large, visible labels
- Easy to read in environments with low light levels

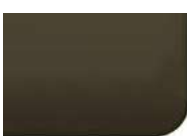
Options and Availability

Finishes, configurations, packaging options and stock availability

Finishes		Inserts	Packaging option	Stock availability
Stainless Steel (SS)		WHITE	Wholesale packaging	MTS
			Shelf ready box & display packaged	MTS
		BLACK	Wholesale packaging	MTS
			Shelf ready box & display packaged	MTS
Polished Chrome (PC)		WHITE	Wholesale packaging	MTS
			Shelf ready box & display packaged	MTS
		BLACK	Wholesale packaging	MTS
			-	-
Satin Brass (SB)		WHITE	Shelf ready box	MTO
			-	-
		BLACK	Shelf ready box	MTS
			Shelf ready box & display packaged	MTS
Mocha Bronze (MB)		WHITE	-	-
			-	-
		BLACK	Wholesale packaging	MTS
			Shelf ready box & display packaged	MTS
Painted White (PW)		WHITE	Shelf ready box	MTO
			-	-
		BLACK	-	-
			-	-
Polished Brass (PB)		WHITE	Shelf ready box	MTO
			-	-
		BLACK	Shelf ready box	MTO
			-	-
Light Copper (LC)		WHITE	Shelf ready box	MTO
			-	-
		BLACK	-	-
			-	-

MTO = made to order | MTS = made to stock



Stainless Steel



Polished Chrome

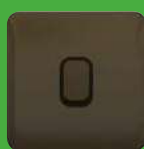

Mocha Bronze



Satin Brass



Polished Brass
*Made to order



Painted White
*Made to order



Light Copper
*Made to order

Socket outlets

13A 1 gang switched



GGBL3010BSS

Product code	Description	Pack qty
GGBL3010***	Single-pole	1
GGBL3010***S	Single-pole (Display packaged)	6
GGBL3010D***	Double-pole	1
GGBL3010D***S	Double-pole (Display packaged)	6
GGBL3011D***	Double-pole with LED indicator	1
GGBL3050NS***S	Single-pole (Non-standard earth) (Display packaged)	6

- **Standard of compliance:** BS 1363-2
- **Mounting box:** Minimum 25mm deep
- **Fixing screws:** M3.5 x 25mm
- **Plate dimensions:** 87 x 87mm

13A 2 gang unswitched



GGBL3060BSS

Product code	Description	Pack qty
GGBL3060***S	2 gang - 13A (Display packaged)	7

13A 2 gang switched with inboard rockers



GGBL3020BSS

Product code	Description	Pack qty
GGBL3020***	Single-pole	1
GGBL3020***S	Single-pole (Display packaged)	6
GGBL3020D***	Double-pole	1
GGBL3020D***S	Double-pole (Display packaged)	6
GGBL3021D***	Double-pole with LED indicator	1

- **Standard of compliance:** BS 1363-2
- **Mounting box:** Minimum 25mm deep
- **Fixing screws:** M3.5 x 30mm
- **Plate dimensions:** 87 x 148mm

Lockable



GGBL3060LBSS

Product code	Description	Pack qty
GGBL3060L***	1 gang 13A Double-pole	1

- **Standard of compliance:** BS 1363-2
- **Mounting box:** Minimum 35mm deep
- **Fixing screws:** M3.5 x 25mm
- **Plate dimensions:** 87 x 148mm

Round pin



GGBL3070BSS

Product code	Description	Pack qty
GGBL3070***	2A unswitched	1
GGBL3080***	5A unswitched	1
GGBL3081***	5A switched	1
GGBL3090***S	15A switched (Display packaged)	5

- **Standard of compliance:** BS 546
- **Mounting box:** Minimum 25mm deep
- **Fixing screws:** M3.5 x 25mm
- **Plate dimensions:** 87 x 87mm



*** = Code for finish option: B or W for interior colour, followed by SS, PC, MB, SB, PB, PW or LC.

Socket outlets continued

Schuko



GGBL3016A1BSS

Product code	Description	Pack qty
GGBL3016A1***	1 gang 16A unswitched	1

- **Standard of compliance:** IEC 60884-1
- **Mounting box:** 47mm deep
- **Fixing screws:** M3.5 x 18mm
- **Plate dimensions:** 87 x 87mm
- **Not for UK use**

USB sockets 13A single-pole – 2.1A total



GGBL30202USBBSSS + GGBLSHF2GBS

Product code	Description	Pack qty
GGBL30102USBA***S	1 gang - 2xUSB (Display packaged)	5
GGBL30202USBA***S	2 gang – 2xUSB (Display packaged)	6
GGBLSHF2GS	2 gang surround with shelf – white (Display packaged)	10
GGBLSHF2GBS	2 gang surround with shelf – black (Display packaged)	10
GGBLSHF1GS	1 gang surround with shelf – white (Display packaged)	10
GGBLSHF1GBS	1 gang surround with shelf – black (Display packaged)	10

- **Standard of compliance:** BS 1363-2 / BS EN 60950-1 / WEEE : EU-directive 2002/95/EC,
- WEEE directive 2002/96/EC
- **Mounting box:** Minimum 35 mm for GGBL30102USBAxxx (supplied with spacer for 25 mm installation)
- minimum 25 mm for GGBL30202USBAxxx
- **Charging capacity:** 5 VDC - 2.1 A, compatible with USB 2.0 devices

- **Smart chip recognizes and optimizes the charging requirements of individual devices**
- **Electronically protected against over voltages and short circuits on either USB outlet (CAT3)**
- **Energy efficient, stand-by power limitation:** 0.5 W (comply with ErP Directive)

Plate switches

10AX 1 gang



GGBL1012BSS

Product code	Description	Pack qty
GGBL1012***	2 way	1
GGBL1012***S	2 way (Display packaged)	7
GGBL1014***	Intermediate	1
GGBL1014***S	Intermediate (Display packaged)	7

- **Standard of compliance:** BS EN 60669-1
- **Mounting box:** 16mm deep (1-2 gang) 25mm deep (3-4 gang)
- **Fixing screws:** M3.5 x 18mm
- **Plate dimensions:** 87 x 87mm (1-3 gang) 87 x 148 mm (4 gang)

10A 1 gang retractive



GGBL1012RBSSS

Product code	Description	Pack qty
GGBL1012R***S	2 way (Display packaged)	7



*** = Code for finish option: B or W for interior colour, followed by SS, PC, MB, SB, PB, PW or LC.

Plate switches continued

10AX 2 & 3 gang



GGBL1022BSS



GGBL1032BSS

Product code	Description	Pack qty
GGBL1022***	2 gang 2 way	1
GGBL1022***S	2 gang 2 way (Display packaged)	7
GGBL1032***	3 gang 2 way	1
GGBL1032***S	3 gang 2 way (Display packaged)	7

- **Standard of compliance:**
BS EN 60669-1
- **Mounting box:**
16mm deep (1-2 gang)
25mm deep (3-6 gang)
- **Fixing screws:**
M3.5 x 18mm
- **Plate dimensions:**
87 x 87 mm (1-3 gang)
87 x 148 mm (4 gang)

10AX 4 gang



GGBL1042BSS

Product code	Description	Pack qty
GGBL1042***	4 gang 2 way	1
GGBL1042***S	4 gang 2 way (Display packaged)	7

10A triple pole isolators



GGBL1013BSS

Product code	Description	Pack qty
GGBL1013***	1 gang triple-pole isolator	1
GGBL1013***S	1 gang triple-pole isolator (Display packaged)	7

- **Standard of compliance:**
BS EN 60947-3
- **Mounting box:**
25mm deep
- **Fixing screws:**
M3.5 x 18mm
- **Plate dimensions:**
87 x 87 mm

10AX 1 gang wide rocker

Product code	Description	Pack qty
GGBL1012WW**	2 way - white rocker	1
GGBL1012WB**	2 way - black rocker	1
GGBL1014WW**	intermediate - white rocker	1
GGBL1014WB**	intermediate - black rocker	1

- **Availability:**
Available by
Q1 2018

10AX 2 & 3 gang wide rocker

Product code	Description	Pack qty
GGBL1022WW**	2 gang - white rocker	1
GGBL1022WB**	2 gang - black rocker	1
GGBL1032WW**	3 gang - white rocker	1
GGBL1032WB**	3 gang - black rocker	1

- **Availability:**
Available by
Q1 2018



*** = Code for finish option:
B or W for interior colour,
followed by SS, PC, MB,
SB, PB, PW or LC.

Dimmer switches

Mains & low voltage



GGBL6012CSSS



GGBL6022CSSS

Product code	Description	Pack qty
GGBL6011C**S	1 gang 1 way - 250W - mains (Display packaged)	5
GGBL6012C**S	1 gang 2 way - 400W/VA (Display packaged)	5
GGBL6022C**S	2 gang 2 way - 250W/VA (Display packaged)	5
GGBL6032C**S	3 gang 2 way - 250W/VA (Display packaged)	5
GGBL6042C**S	4 gang 2 way - 250W/VA (Display packaged)	5

- **Standard of compliance:**
BS EN 60669-2-1
- **Mounting box:**
16mm deep
(GGBL6011Cxxx)
25mm deep
- **Fixing screws:**
M3.5 x 25mm
- **Plate dimensions:**
87 x 87mm (1-2 gang)
87 x 148.5mm (3-4 gang)
- **Technical notes:**
Leading edge control (LED Dimmer)
Trailing edge control
- **Note:**
Retractive switches are required for Multi-Way Operation when using LED dimmers

LED Dimmers



GGBL6012LSSS

Product code	Description	Pack qty
GGBL6012L**S	1 gang 2 way LED - 100W/VA (Display packaged)	5
GGBL6022L**S	2 gang 2 way LED - 100W/VA (Display packaged)	5

Control switches & flex outlet plates

20AX DP 1 gang



GGBL2010BSSS

Product code	Description	Pack qty
GGBL2010***S	1 gang (Display packaged)	7
GGBL2011***	1 gang LED Indicator	1
GGBL2011***S	1 gang LED Indicator (Display packaged)	7
GGBL2014WH***	1 gang Flex Outlet & LED Indicator marked 'Water Heater'	1

- **Standard of compliance:**
BS EN 60669-1
- **Mounting box:**
25mm deep
- **Plate dimensions:**
87 x 87mm (1 gang)

Fused connection units

13A unswitched



GGBL5000BSS

Product code	Description	Pack qty
GGBL5000***	Unswitched FCU - 13A	1
GGBL5000***S	Unswitched FCU - 13A (Display packaged)	7
GGBL5003***	Unswitched FCU - Flex Outlet	1
GGBL5003***S	Unswitched FCU - Flex Outlet (Display packaged)	7

- **Standard of compliance:** BS 1363
- **Mounting box:** 25mm deep
- **Fixing screws:** M3.5 x 25mm
- **Plate dimensions:** 87 x 87mm

13A DP switched



GGBL5010BSS

Product code	Description	Pack qty
GGBL5010***	Switched FCU	1
GGBL5010***S	Switched FCU (Display packaged)	7
GGBL5011***	Switched FCU with LED Indicator	1
GGBL5013***	Switched FCU with Flex Outlet and LED indicator	1

High current switches

50A DP switches with LED indicator



GGBL4021BSS

Product code	Description	Pack qty
GGBL4011***	1 gang	1
GGBL4021***	2 gang	1
GGBL4021***S	2 gang (Display packaged)	6

- **Standard of compliance:** BS EN 60669-1 (Cooker control) BS 4177
- **Mounting box:** 40mm deep
- **Fixing screws:** M3.5 x 30mm
- **Plate dimensions:** 87 x 87mm (1 gang)
87 x 148mm (2 gang)

45A cooker control unit with 13A switched socket



GGBL4001BSS

Product code	Description	Pack qty
GGBL4001***	Cooker control unit with LED Indicator	1
GGBL4001***S	Cooker control unit with LED Indicator (Display packaged)	6

Shaver socket

115/230V dual voltage



GGBL7090BSSS

Product code	Description	Pack qty
GGBL7090***S	115/230V dual voltage (Display packaged)	1

- **Standard of compliance:** BS EN 61558-2-5
- **Mounting box:** 40mm deep
- **Fixing screws:** M3.5 x 30mm
- **Plate dimensions:** 148 x 87mm



*** = Code for finish option: B or W for interior colour, followed by SS, PC, MB, SB, PB, PW or LC.

Telephone, USB and data outlets

USB charger outlet



GGBL70042BSSS

Product code	Description	Pack qty
GGBL70042***S	1gang 2xUSB – 3.1A total (Display packaged)	5

- **Charging capacity** : 5 VDC - 3.1 A, compatible with USB 2.0 devices
- **Smart chip recognizes and optimizes the charging requirements of individual devices**
- **Electronically protected against over voltages and short circuits on either USB outlet (CAT3)**
- **Energy efficient, stand-by power limitation** : 0.5 W (comply with ErP Directive)

- **Standard of compliance:**
BS EN 60950-1 / WEEE : EU-directive 2002/95/EC, WEEE directive 2002/96/EC
- **Mounting box:**
35mm deep
- **Fixing screws:**
M3.5 x 25mm
- **Plate dimensions:**
87 x 87mm

Telephone



GGBL7061BSS

Product code	Description	Pack qty
GGBL7051***S	RJ12 (Display packaged)	5
GGBL7061***	BT Master – single	1
GGBL7061***S	BT Master – single (Display packaged)	7
GGBL7062***	BT Secondary – single	1
GGBL7062***S	BT Secondary – single (Display packaged)	7

- **Standard of compliance:**
BS EN 41003
- **Mounting box:**
25mm deep
- **Fixing screws:**
M3.5 x 18mm
- **Plate dimensions:**
87 x 87mm

RJ45 CAT5e UTP



GGBL7071C5BSS

Product code	Description	Pack qty
GGBL7071C5***S	RJ45 Cat 5e - single (Display packaged)	5
GGBL7072C5***S	RJ45 Cat 5e -twin (Display packaged)	5

- **Standard of compliance:**
ANSI/TIA-568-C.2
- **Mounting box:**
25mm deep
- **Fixing screws:**
M3.5 x 18mm
- **Plate dimensions:**
87 x 87mm

RJ45 CAT6 UTP



GGBL7072C6BSSS

Product code	Description	Pack qty
GGBL7071C6***S	RJ45 Cat 6 - single (Display packaged)	5
GGBL7072C6***S	RJ45 Cat 6 – twin (Display packaged)	5



*** = Code for finish option: B or W for interior colour, followed by SS, PC, MB, SB, PB, PW or LC.

TV outlets

Coaxial sockets



Product code	Description	Pack qty
GGBL7010***	TV/FM – Single	1
GGBL7010***S	TV/FM – Single (Display packaged)	7
GGBL7020***S	TV-R/DAB - Diplex (Display packaged)	5
GGBL7030***S	Satellite "F" Type (Display packaged)	7

- **Mounting box:**
25mm for GGBL7010xxx and GGBL7030xxx
- 35mm for GGBL7020xxx
- **Fixing screws:**
M3.5 x 18 mm for GGBL7010xxx and GGBL7030xxx
- M3.5 x 25 mm for GGBL7020xxx
- **Plate dimensions:**
87 x 87mm

Combination plates

Quadplex combination



Product code	Description	Pack qty
GGBL707445510***S	Quadplex RJ45 Cat5e & TV Return (Display packaged)	5
GGBL707445511***S	Quadplex RJ45 Cat5e & RJ12 (Display packaged)	5
GGBL70746110***S	TV/FM/2xSAT & Telephone & TV Return - Quadplex BT Secondary & TV Return (Display packaged)	6
GGBL7074***S	Quadplex TV-R/DAB & 2xSAT (Display packaged)	5

- **Standard of compliance:**
BS EN 5733 for GGBL7074***S
- ANSI/TIA-568-C.2 for GGBL70744551***S
- **Mounting box:**
35mm deep
- **Fixing screws:**
M3.5 x 25mm
- **Plate dimensions:**
87 x 87mm (1 gang)
87 x 148.5mm (2 gang)
- RJ45 Cat5e & RJ12 BT secondary and TV coaxial return

Triplex combination



Product code	Description	Pack qty
GGBL7081456***S	Triplex TV-R/DAB & RJ45 Cat6 (Display packaged)	5
GGBL7081***S	Triplex TV-R/DAB & SAT (Display packaged)	5

- **Standard of compliance:**
BS5733
- **Mounting box:**
Dimension: 160 x 270 x 47 mm depth
- **Plate dimensions:**
174 x 295 mm
- Euro modules plates compatible with Schneider Electric euro modules.
- **Note:** modules from other suppliers may not be compatible, it is advised to check suitability.

Socket & media combination plate



Product code	Description	Pack qty
GGBL3020D4MP***	2x2 gang 13A socket, 2x2 module euro outlets, quadplex, BT secondary & TV return	1

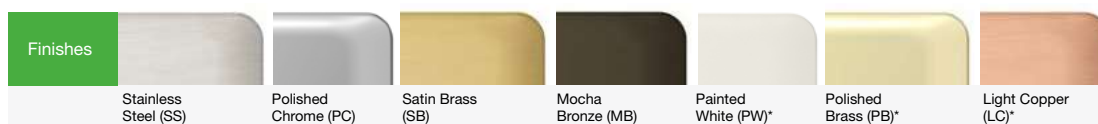

*** = Code for finish option: B or W for interior colour, followed by SS, PC, MB, SB, PB, PW or LC.

Frames, blank plates & accessories

Frames, surrounds & spacers



Product code	Description	Pack qty
GGBLC1GBS	1G surround with clip - Black (Display packaged)	10
GGBLC1GS	1G surround with clip - White (Display packaged)	10
GGBLH1GSBS	1G surround with hook - Black (Display packaged)	10
GGBLH1GS	1G surround with hook - White (Display packaged)	10
GGBLSHF2GBS	2G surround with shelf - Black (Display packaged)	10
GGBLSHF2GS	2G surround with shelf - White (Display packaged)	10
GGBLSHF1GBS	1G surround with shelf - Black (Display packaged)	10
GGBLSHF1GS	1G surround with shelf - White (Display packaged)	10
GGBLSPC1BS	1G spacer - Black (Display packaged)	20
GGBLSPC1S	1G spacer - White (Display packaged)	20
GGBLSPC2BS	2G spacer - Black (Display packaged)	20
GGBLSPC2S	2G spacer - White (Display packaged)	20

- **Standard of compliance:** BS EN 5733
- **Plate dimensions:** 87 x 87mm (1 gang)
87 x 148.5mm (2 gang)

Blank plates & accessories



Product code	Description	Pack qty
GGBL8010**	1 gang	1
GGBL8010**S	1 gang (Display packaged)	10
GGBL8020**	2 gang	1
GGBL8020**S	2 gang (Display packaged)	10
GGBLSIND	LED indicators	5
USCREW50SS	M3.5 x 50mm screws	100

- **Standard of compliance:** BS EN 5733
- **Fixing screws:** M3.5 x 18mm (blank plates only)
- **Plate dimensions:** 87 x 87mm (1 gang)
87 x 148.5mm (2 gang)

Grid plates

88 x 88mm



Product code	Description	Pack qty
GGBL01G***	1 module - Incl. Mounting Grid	1
GGBL02G***	2 module - Incl. Mounting Grid	1
GBG01	76x76x42mm flush mounted back box	1

- **Mounting box:** 42mm deep
- **Fixing screws:** M3.5 x 30mm

88 x 148mm



Product code	Description	Pack qty
GGBL03G***	3 module - Incl. Mounting Grid	1
GGBL04G***	4 module - Incl. Mounting Grid	1
GBG02	136x76x42mm flush mounted back box	1

156 x 156mm



Product code	Description	Pack qty
GGBL06G***	6 module - Incl. Mounting Grid	1
GGBL08G***	8 module - Incl. Mounting Grid	1
GBG03	136x136x42mm flush mounted back box	1

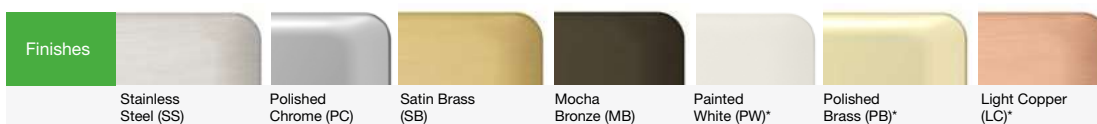

*** = Code for finish option: B or W for interior colour, followed by SS, PC, MB, SB, PB, PW or LC.

Grid plates continued

216x156mm

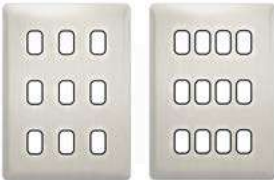

GGBL09GBSS GGBL12GBSS

Product code	Description	Pack qty
GGBL09G***	9 module - Incl. Mounting Grid	1
GGBL12G***	12 module - Incl. Mounting Grid	1
GBG04F	193x133x42mm flush mounted back box	1

- **Mounting box:**
42mm deep
- **Fixing screws:**
M3.5 x 30mm

Grid Modules

Switch modules



GGBL2020M GGBLG2011SS

Product code	Description	Pack qty
GGBL102M	10AX - 2 way (component module - add rocker cap)	6
GGBL10IM	10AX - Intermediate (component module - add rocker cap)	6
GGBL201M	20AX - 1 way (component module - add rocker cap)	6
GGBL2020M	20AX - 2 way Centre Off (component module - add rocker cap)	6
GGBL202M	20AX - 2 way (component module - add rocker cap)	6
GGBL20DPM	20AX Double-pole (component module - add rocker cap)	6
GGBLG2011**	20AX Double-pole with LED indicator	6

- **Standard of compliance:**
BS EN 60669-1
(switch modules)
BS 5733
(indicator modules)
BS EN 41003 (fused connection units)
- **Mounting box:**
42mm deep

Plain and printed rocker caps for component modules



GGBLRSS

Product code	Description	Pack qty
GGBLR**	Plain cap cover	6
GGBLRCH**	Rocker cap printed cooker hood	6
GGBLRDW**	Rocker cap printed dish washer	6
GGBLREF**	Rocker cap printed extractor fan	6
GGBLRFA**	Rocker cap printed fan	6
GGBLRFFZ**	Rocker cap printed Fridge/freezer	6
GGBLRFR**	Rocker cap printed Fridge	6
GGBLRFZ**	Rocker cap printed Freezer	6
GGBLRHO**	Rocker cap printed Hob	6
GGBLRHT**	Rocker cap printed Heater	6
GGBLRMW**	Rocker cap printed Microwave	6
GGBLROV**	Rocker cap printed Oven	6
GGBLRTD**	Rocker cap printed Tumble dryer	6
GGBLRBO**	Rocker cap printed Boiler	6
GGBLRBOT**	Rocker cap printed Boost	6
GGBLRMVHR**	Rocker cap printed MVHR	6
GGBLRWM**	Rocker cap printed Washing machine	6
GGBLRWCL**	Rocker cap printed Wine cooler	6



*** = Code for finish option:
B or W for interior colour,
followed by SS, PC, MB,
SB, PB, PW or LC.

Grid Modules continued

Retractive switch modules



GGBL102RSS

Product code	Description	Pack qty
GGBL102R**	2 way Retractive - 10A	6
GGBL202OC**	2 way Retractive Centre Off - 10A	6

• **Standard of compliance:**
BS EN 60669-1

Key switch modules



GGBL20DPKELSS

Product code	Description	Pack qty
GGBL202K**	20AX – 2 way	6
GGBL20DPKEL**	20AX Double-pole printed Test Emg Ltg	6
GGBL20DPK**	20AX Double-pole	6

Fused connection unit, USB charger & blank modules



GGBL13FCUBSS GGBLE7004B

Product code	Description	Pack qty
GGBL13FCU***	13A fused connection unit	6
GGBLB**	Blank Module	6
GGBLE7004B	USB charger Grid Module – 1x USB (1A) – Black	6
GGBLE7014	USB Grid Module – 1xUSB (1A) - White	1

• **Standard of compliance:**
BS 5733
(FCU and blank module),
BS EN 60950-1
(USB charger)

20A Double-pole Sink Bath Switch with Neon



GGBL2022IMRSS

Product code	Description	Pack qty
GGBL2022IMR**	20A DP Dual Control Bath-Sink / LED	1

• **Standard of compliance:**
BS EN 60669-1

LED dimmer

Product code	Description	Pack qty
GGBLGRDIML**	LED grid dimmer	1

• **Mounting box:**
35mm deep

• **Fixing screws:**
M3.5 x 30mm

• **Plate dimensions:**
87 x 87mm (1 gang)
87 x 148.5mm (2 gang)

Indicator Modules



GGBLINDWG GGBLINDWR

Product code	Description	Pack qty
GGBLINDWG	Green indicator	1
GGBLINDWR	Red indicator	1
GGBLINDWO	Orange indicator	1

• **Note:**
Retractive switches are required for Multi-Way Operation when using LED dimmers

Grid inserts (spare)

Product code	Description	Pack qty
GGBLSRU7004W	USB grid insert - White (spare part for GGBLE7004 or GGBLE7014 only)	1
GGBLSRU7004B	USB grid insert - Black (spare part for GGBLE7004B only)	1
GGBLSR7004W	Grid insert - White (generic)	20
GGBLSR7004B	Grid insert - Black (generic)	20

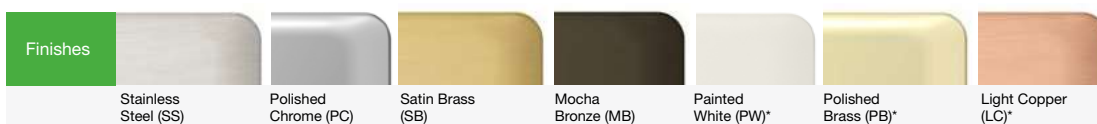

*** = Code for finish option:
B or W for interior colour,
followed by SS, PC, MB,
SB, PB, PW or LC.

Euro plates & modules

Euro plates



GGBL8050SS GGBL8080SS

Product code	Description	Pack qty
GGBL8050**	1 gang - 1 module	1
GGBL8060**	1 gang - 2 module	1
GGBL8080**	2 gang - 4 module	1

- Euro modules plates compatible with Schneider Electric euro modules.
- **Note:** modules from other suppliers may not be compatible, it is advised to check suitability.

25 x 50mm euro modules



GUE7011W



GUE7071W

Product code	Description	Pack qty
GUE7011*	Single IEC coax (female)	1
GUE7012*	Single IEC coax (male)	1
GUE7030*	Single F type sat	1
GUE7061*	BT master telephone	1
GUE7062*K	BT secondary telephone	1
GUE7071*	RJ45 CAT5e (not screened)	1
GUE7072*	RJ45 CAT6 (not screened)	1
GUE7051*	RJ11 modem	1
GUE7075*	VGA	1
GUE7091*	LexCom Performance outlet	8
GUE7000*	2 x Phono socket	1
GUE7001*	2 x Loudspeaker socket	1
GUE8010*	Blank module	5
GUE7073*	1A USB charger	1

- **Mounting box:** 25mm deep
- **Euro module dimensions:** 25 x 50mm (single)

50 x 50mm euro modules



GUE7010W

Product code	Description	Pack qty
GUE7010*	TV/FM diplexer	1
GUE7040*	TV/Sat diplexer	1
GUE7081*	TV/FM/Sat triplexer	1
GUE7082*	TV/FM/Sat1/Sat2 quadplexer	1
GUE7020*	HDMI	1
GUE7074*	2 x 1A USB charger**	1
GGBLGUE7078*	American power socket**	1
GUE7076*	Brush outlet**	1
GUE7077*	5A round pin socket**	1
GGBGUE7079*	European socket**	1

- **Mounting box:** 35mm deep
- **Euro module dimensions:** 55 x 50mm (double)
- ****MTO products** for projects only, leadtime to be confirmed at time of ordering



*** = Code for finish option: B or W for interior colour, followed by SS, PC, MB, SB, PB, PW or LC.

Flush galvanised steel boxes

16mm deep



SB161

Product code	Description	Pack qty
SB161	1 gang	20

25mm deep



SB252

Product code	Description	Pack qty
SB251	1 gang	10
SB252	2 gang	10

35mm deep



SB351

Product code	Description	Pack qty
SB351	1 gang	10
SB352	2 gang	5

47mm deep



SB472

Product code	Description	Pack qty
SB471	1 gang	10
SB472	2 gang	4

- **Standard of compliance:**
BS 4662

- **Technical notes:**
Supplied with earth terminal and screw.

Supplied with fixed and adjustable lugs.

Fitted with selection of 20mm knockouts in sides and back.



Lisse

Curves in all the right places...

The Lisse white moulded range of wiring accessories offers the perfect blend of style and performance.

You no longer have to choose between convenience and efficiency, or compromise on appearance to get the most innovative features. Lisse is packed with a vast array of technical features, providing a high level of quality, reliability and value you can count on.



- Ideally suited for new construction and refurbishment projects
- Future-proofed to cater for the latest demands in consumer technology
- Made from durable, high quality urea with antimicrobial properties
- Cleverly designed to ensure that product ordering is simple and efficient, with many time and space saving solutions.
- Crafted with your customer in mind, adding bespoke solutions to make a lasting impact

Quality as standard...

The smooth, modern lines of Lisse offer an understated elegance to compliment today's interiors.

Not only that - every attention to detail has been paid to the design and construction of this elegant white moulded range, built to make your installation faster, smoother, simpler...

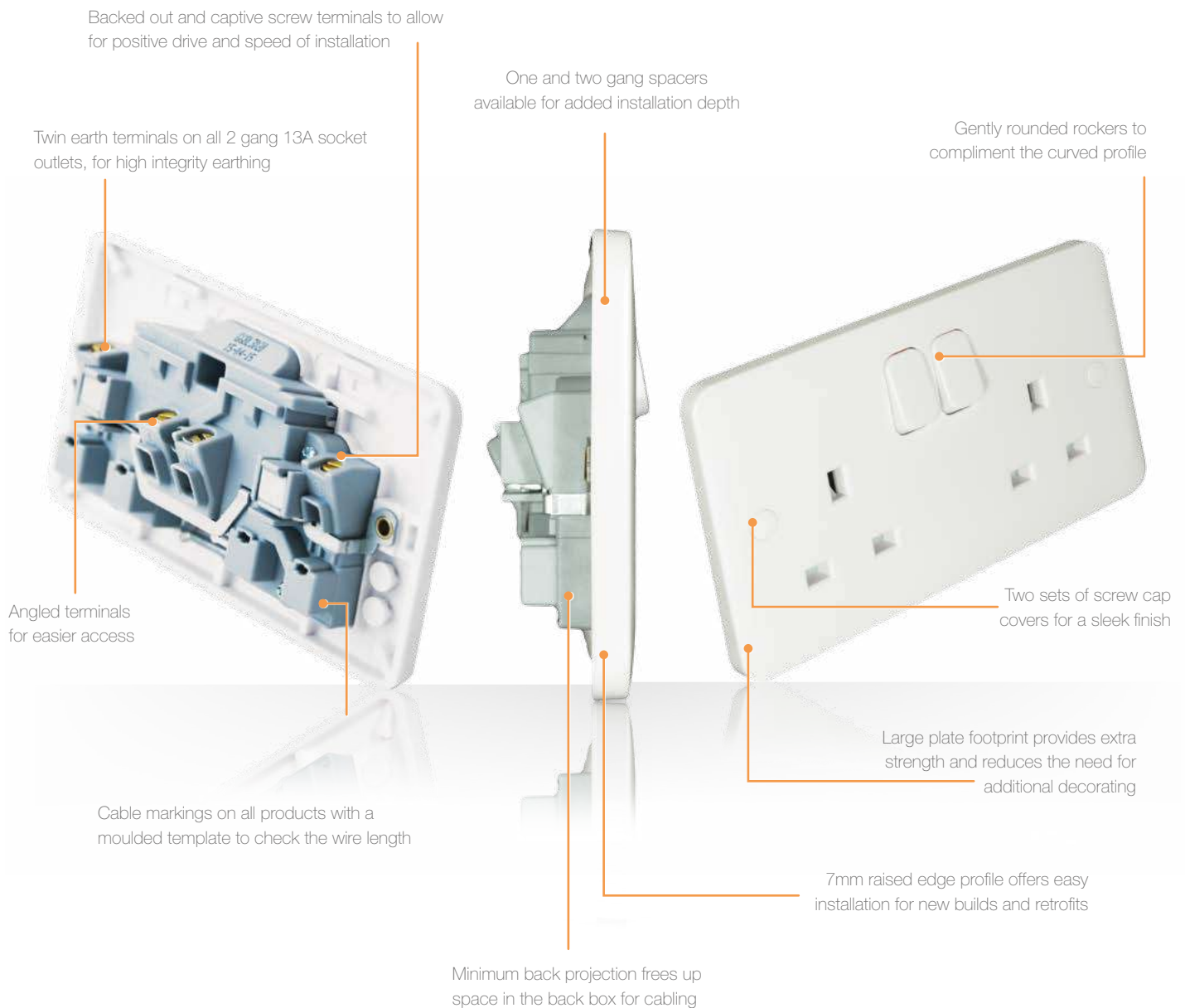

Tailored to meet your needs...



Lisse has been cleverly designed to ensure that product ordering is simple and efficient, with many time and space saving solutions. What does this mean for you? Faster ordering, fewer part references and greater installation flexibility.



Clever Illumination

Enjoy the subtle but elegant illumination provided by Lisse LED indicators. This optional feature shines through the front plate moulding when additional power indication is needed. Installation couldn't be easier, as the LED indicators are simply clipped in to place via a purpose-built holding space on the back of the front plate and leverage dedicated push terminals for cabling.



Flexible Frames

Optional Flex outlet frames offer the additional cabling depth you need on site, without having to hold stock variations of the same product. Simply clip in to place with your standard FCU or control switch to install. One and two gang spacers are also available to provide the perfect solution for remodels and retrofits when extra installation depth is needed.



Fully Antimicrobial

Lisse wiring devices can be used seamlessly with the Ultimate or Cableline anti-microbial 3 compartment trunking systems, to provide a high level of resistance to MRSA, E-Coli, Salmonella and Klebsiella Penumoniae.

For every application

With such a comprehensive product range, Lisse white moulded allows you to find everything that you need to meet the demands of today's modern installations.

Flexible Grid Solutions

Available in 1 to 8 gang with accompanying modules. Installation is made easy with its slot headed screw design, and ordering is simplified as mounting frames are supplied with each grid front plate.



Added Safety & Security

The Lisse lockable socket or switch is ideal for communal areas in order to prevent injury risks and unauthorised energy usage.



Stay connected

Help customers stay connected to their TVs, game consoles, computers, and sound systems with Lisse. Choose from a full range of multimedia connectors, USB charging solutions, and combination plates.



Dimming Genius

Enjoy a comprehensive selection of dimming solutions with Lisse white moulded, from mains & low voltage compatibility through to LED, as well as the addition of 1-10V 6A control.



Easy Conversions

The Lisse converta socket is an ideal retrofit solution when mounting box space is limited. Allows single to double socket conversion without the need for additional cabling or chasing.





Socket outlets

13A unswitched



GGBL3050

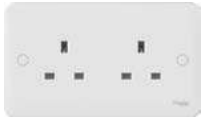

GGBL3060

Product code	Description	Pack qty
GGBL3050	1 gang	10
GGBL3050S	1 gang - display packaged	10
GGBL3060	2 gang	5
GGBL3060S	2 gang - display packaged	5

- **Standard of compliance:**
BS 1363 (13A)
- **Mounting box:**
Minimum 25mm deep
- **Fixing screws:**
M3.5 x 25mm
- **Plate dimensions:**
87 x 87mm (1 gang)
87 x 148.5mm (2 gang)
- **Technical notes:**
 - ✔ Product compatible with LED indicator GGBLSIND.



13A 1 gang switched



GGBL3010



GGBL3050NS



GGBLTOP13ANS

Product code	Description	Pack qty
GGBL3010	Single-pole ✔	10
GGBL3010S	Single-pole - display packaged ✔	10
GGBL3010D	Double-pole ✔	10
GGBL3010DS	Double-pole - display packaged ✔	10
GGBL3050NS	Single-pole non-standard - display packaged ✔	10
GGBLTOP13ANS	Non-standard plug top - display packaged ✔	20

13A 2 gang switched with inboard rockers

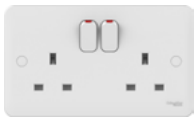

GGBL3020D

Product code	Description	Pack qty
GGBL3020	Single-pole ✔	5
GGBL3020S	Single-pole - display packaged ✔	5
GGBL3020DS	Double-pole - display packaged ✔	5
GGBL3020D	Double-pole ✔	5

13A 2 gang with outboard rockers



GGBL3030



GGBL30212DS

Product code	Description	Pack qty
GGBL3030	Double-pole ✔	5
GGBL3030S	Double-pole - display packaged ✔	5
GGBL30212DS	1 to 2 gang converta - display packaged ✔	5

Lockable



GGBL3060L

Product code	Description	Pack qty
GGBL3060L	1 gang double-pole	5

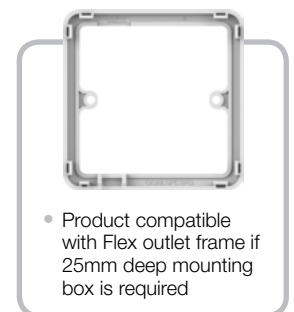

- Product compatible with Flex outlet frame if 25mm deep mounting box is required

Round pin



GGBL3070 GGBL3080



GGBL3090

Product code	Description	Pack qty
GGBL3070	2A unswitched	10
GGBL3080	5A unswitched	10
GGBL3081	5A switched	10
GGBL3090	15A switched	10
GGBL3090S	15A switched - display packaged	10

- **Standard of compliance:**
BS 546 (round pin)
BS 5733
BS EN 60950
- **Mounting box:**
Minimum 25mm deep
- **Fixing screws:**
M3.5 x 25mm
- **Plate dimensions:**
87 x 87mm (1 gang)

Product compatible with LED indicator GGBLSIND.

* Not for UK use

Schuko



GGBL3016A1

Product code	Description	Pack qty
GGBL3016A1	16A 1 gang unswitched*	10

USB Sockets



GGBL30202USBS & GGBLSHF2GS

Product code	Description	Pack qty
GGBL30202USBS**	2 gang SP switched socket outlet with 2 x USB	1
GGBLSHF2GS	Shelf frame	10

- **Mounting box:**
25mm back box dependent on wiring configuration

Plate switches

10AX 1 gang



GGBL1012

Product code	Description	Pack qty
GGBL1011	1 way	10
GGBL1011S	1 way - display packaged	10
GGBL1012	2 way	10
GGBL1012S	2 way - display packaged	10
GGBL1014	Intermediate	10
GGBL1014S	Intermediate - display packaged	10

- **Standard of compliance:**
BS EN 60669-1
- **Mounting box:**
16mm deep (1-2 gang)
25mm deep (3 gang)
- **Fixing screws:**
M3.5 x 18mm
- **Plate dimensions:**
87 x 87mm (1-3 gang)

10A 1 gang retractive



GGBL1012RP GGBL1012RB

Product code	Description	Pack qty
GGBL1012R	1 gang	10
GGBL1012RS	1 gang - display packaged	10
GGBL1012RP	1 gang printed with press	10
GGBL1012RPS	1 gang printed with press - display packaged	10
GGBL1012RB	1 gang 2 way printed with bell symbol	10
GGBL1012RBS	1 gang printed with bell symbol - display packaged	10

10AX 2 & 3 gang



GGBL1022 GGBL1032

Product code	Description	Pack qty
GGBL1022	2 gang 2 way	10
GGBL1022S	2 gang 2 way - display packaged	10
GGBL1032	3 gang 2 way	10
GGBL1032S	3 gang 2 way - display packaged	10

Plate switches continued

10AX 4 gang



GGBL1042

Product code	Description	Pack qty
GGBL1042	4 gang 2 way	5
GGBL1042S	4 gang 2 way - display packaged	5

10A triple pole isolators & 10AX



GGBL1013

GGBL10131L



GGBL10131R

Product code	Description	Pack qty
GGBL1013	Triple pole isolator	10
GGBL1013S	Triple pole isolator - display packaged	10
GGBL10131L	Isolator & 10AX 1 gang 2 way switch	5
GGBL10131R	1 gang 2 way switch & 10A isolator	5

- **Standard of compliance:**
BS EN 60669-1
BS EN 60947-3
(GGBL1013,
GGBL10131L,
GGBL10131R)
- **Mounting box:**
16mm deep (1-2 gang)
25mm deep (3-6 gang)
- **Fixing screws:**
M3.5 x 18mm
- **Plate dimensions:**
87 x 148.5mm (4 gang)
87 x 87mm (wide
rockers)
33 x 87mm
(1 gang architrave)
33 x 148.5mm
(2 gang architrave)

10AX 1 gang wide rocker

GGBL1012W
& GGBL1014

Product code	Description	Pack qty
GGBL1012W	2 way	10
GGBL1012WS	2 way - display packaged	10
GGBL1014W	Intermediate	10
GGBL1014WS	Intermediate - display packaged	10

10AX 2 & 3 gang wide rocker



GGBL1022W

GGBL1032W

Product code	Description	Pack qty
GGBL1022W	2 gang 2 way	10
GGBL1022WS	2 gang 2 way - display packaged	10
GGBL1032W	3 gang 2 way	10
GGBL1032WS	3 gang 2 way - display packaged	10

10AX architrave



GGBL1012ARP

Product code	Description	Pack qty
GGBL1012A	1 gang 2 way	10
GGBL1012AS	1 gang 2 way - display packaged	10
GGBL1012116AS	1 gang 2 way & 16mm pattress - display packaged	10
GGBL1012ARP	1 gang 2 way retractive printed press	10
GGBL1022A	2 gang 2 way	10

Dimmer switches

Mains & low voltage



GGBL6012CS

Product code	Description	Pack qty
GGBL6011CS	250W 1 gang 1 way mains - display packaged	5
GGBL6012CS	400W/VA 1 gang 2 way - display packaged	5
GGBL6022CS	250W/VA 2 gang 2 way - display packaged	5
GGBL6032CS	250W/VA 3 gang 2 way - display packaged	5
GGBL6042CS	250W/VA 4 gang 2 way mains & low voltage - display packaged	5

1-10V 6A



GGBL6022V4S

Product code	Description	Pack qty
GGBL6012V4S	1 gang 2 way - display packaged	5
GGBL6022V4S	2 gang 2 way - display packaged	5
GGBL6032V4S	3 gang 2 way - display packaged	5
GGBL6042V4S	4 gang 2 way - display packaged	5

LED



GGBL6012LS GGBL6022LS

Product code	Description	Pack qty
GGBL6012LS	100W/VA 1 gang 2 way - display packaged	5
GGBL6022LS	100W/VA 2 gang 2 way - display packaged	5

- **Standard of compliance:** BS EN 60669-2-1
- **Mounting box:** 16mm deep (GGBL6011CS) 25mm deep
- **Fixing screws:** M3.5 x 18mm (GGBL6011CS) M3.5 x 25mm
- **Plate dimensions:** 87 x 87mm (1-2 gang) 87 x 148.5mm (3-4 gang)
- **Technical notes:** Mains & low voltage dimmers: leading edge control
LED Dimmers: trailing edge control
- **Note:** retractive switches are required for Multi-Way Operation when using LED dimmers

Control switches & flex outlet plates

20AX DP 1 gang switched 20AX DP 1 gang switched with LED indicator



GGBL2010



GGBL2010LS

Product code	Description	Pack qty
GGBL2010	1 gang	10
GGBL2010LS	Lockable - display packaged	5

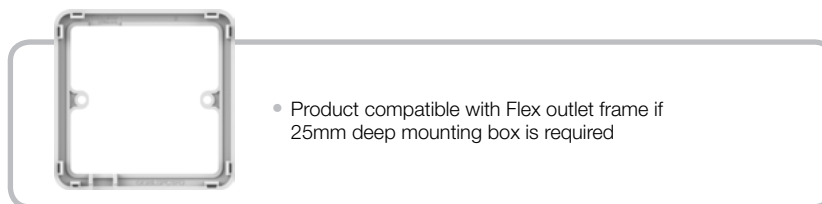

- **Standard of compliance:** BS EN 60669-1 (switches)
- **Mounting box:** 25mm deep
- **Fixing screws:** M3.5 x 25mm
- **Plate dimensions:** 87 x 87mm (1 gang)
- **Technical notes:** Product compatible with LED indicator GGBLSIND. Custom engraving available upon request.

20AX DP 1 gang switched with LED indicator



GGBL2011

Product code	Description	Pack qty
GGBL2011	1 gang	10
GGBL2011S	1 gang - display packaged	10
GGBL2014WH	1 gang with flex outlet frame engraved water heater	10

- **Standard of compliance:** BS EN 60669-1 (switches) BS 5733 (flex outlet plates)
- **Mounting box:** 25mm deep
- **Fixing screws:** M3.5 x 25mm
- **Plate dimensions:** 87 x 87mm

Control switches & flex outlet plates continued

20A DP Sink Bath Switch with Neon



GGBL2022IMR

Product code	Description	Pack qty
GGBL2022IMR	20A DP Sink Bath Switch with Neon	10

- **Standard of compliance:**
BS EN 60669-1 (switches)
BS 5733 (flex outlet plates)
- **Mounting box:**
25mm deep
- **Fixing screws:**
M3.5 x 25mm
- **Plate dimensions:**
87 x 87mm

32A DP 1 gang switched



GGBL4031

Product code	Description	Pack qty
GGBL4031	DP 1 gang with LED indicator	10

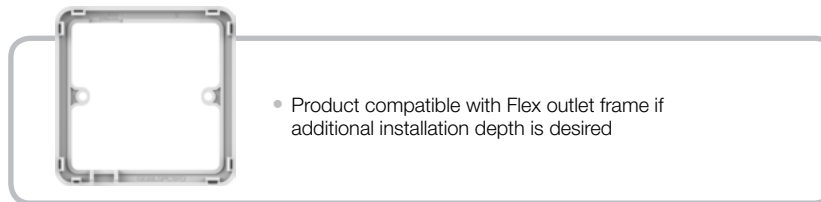

Flex outlet plates

GGBL2033,
GGBL2033S

Product code	Description	Pack qty
GGBL2033	25A side entry	10
GGBL2033S	25A side entry - display packaged	10

- Custom engravings available upon request.

Fused connection units

13A unswitched



GGBL5000

Product code	Description	Pack qty
GGBL5000	13A unswitched	10
GGBL5000S	13A unswitched - display packaged	10
GGBL5000AL	13A Unswitched FCU / Printed / ALARM	10

- **Standard of compliance:**
BS 1363
- **Mounting box:**
25mm deep
- **Fixing screws:**
M3.5 x 25mm
- **Plate dimensions:**
87 x 87mm
- **Technical notes:**
 Product compatible with LED indicator GGBLSIND.
- Custom engravings available upon request.

13A DP switched



GGBL5010

Product code	Description	Pack qty
GGBL5010	13A DP switched	10
GGBL5011	13A DP switched with LED indicator	10
GGBL5013S	13A DP switched - display packaged	10



13 DP switched FCU / Red engraving

Product code	Description	Pack qty
GGBL5010BOR	13A DP SW FCU / ENGRAVED / RED / BOILER	10
GGBL5010CER	13A DP SW FCU / ENGRAVED / RED / CENTRAL HEATING	10
GGBL5010FRR	13A DP SW FCU / ENGRAVED / RED / FRIDGE	10
GGBL5010FFR	13A DP SW FCU / ENGRAVED / RED / FRIDGE FREEZER	10
GGBL5010FAR	13A DP SW FCU / ENGRAVED / RED / FAN	10
GGBL5010WMR	13A DP SW FCU / ENGRAVED / RED / WASHING MACHINE	10
GGBL5010CHR	13A DP SW FCU / ENGRAVED / RED / COOKER HOOD	10
GGBL5010TDR	13A DP SW FCU / ENGRAVED / RED / TUMBLE DRYER	10
GGBL5010BO	13A DP Switched FCU / PRINTED / BOILER	10

- **Standard of compliance:** BS EN 61558-2-5
- **Mounting box:** 40mm deep
- **Fixing screws:** M3.5 x 30mm
- **Plate dimensions:** 148.5 x 87mm

High current switches

50A DP switches with LED indicator



GGBL4011



GGBL4021

Product code	Description	Pack qty
GGBL4011	1 gang	5
GGBL4011S	1 gang - display packaged	10
GGBL4021	2 gang	5
GGBL4021S	2 gang - display packaged	5
GGBL4021SHW	50A 2 Gang DP Switch / Printed / SHOWER	5
GGBL4011OVW	1G 50A DP Switch / Printed / OVEN	5
GGBL4011MWW	1G 50A DP Switch / Printed / MICROWAVE	5

- **Standard of compliance:** BS EN 60669-1 (switches) BS 4177 (cooker control units)
- **Mounting box:** 40mm deep
- **Fixing screws:** M3.5 x 30mm
- **Plate dimensions:** 87 x 87mm (1 gang) 148.5 x 87mm (2 gang)

45A cooker control unit with 13A switched socket



GGBL4001

Product code	Description	Pack qty
GGBL4001	45A cooker control unit with LED indicators	1
GGBL4001S	45A cooker control unit with LED indicators - display packaged	5

50A cooker connection unit



GGBL4050

Product code	Description	Pack qty
GGBL4050	50A cooker connection unit	10
GGBL4050S	50A cooker connection unit - display packaged	10

Shaver socket

115/230V dual voltage



GGBL7090S

Product code	Description	Pack qty
GGBL7090S	115/230V dual voltage - display packaged	1

- **Standard of compliance:** BS EN 61558-2-5
- **Mounting box:** 40mm deep
- **Fixing screws:** M3.5 x 30mm
- **Plate dimensions:** 148.5 x 87mm

Telephone & data outlets

USB charger outlets



GGBL70042

Product code	Description	Pack qty
GGBL70042	1 gang 2 x USB chargers	10
GGBL70042S	1 gang 2 x USB chargers - display packaged	10

- **Standard of compliance:** BS EN 41003
- **Mounting box:** 25mm deep
- **Fixing screws:** M3.5 x 18mm
- **Plate dimensions:** 87 x 87mm

Telephone



GGBL7051

GGBL7061,
GGBL7062

Product code	Description	Pack qty
GGBL7051	RJ11	10
GGBL7051S	RJ11 - display packaged	10
GGBL7061	BT master	10
GGBL7061S	BT master - display packaged	10
GGBL7062	BT secondary	10
GGBL7062S	BT secondary - display packaged	10

RJ45 CAT5e UTP



GGBL7072C5

Product code	Description	Pack qty
GGBL7071C5	RJ45 CAT5e UTP single	10
GGBL7071C5S	RJ45 CAT5e UTP single - display packaged	10
GGBL7072C5	RJ45 CAT5e UTP twin	10
GGBL7072C5S	RJ45 CAT5e UTP twin - display packaged	10

RJ45 CAT6 UTP



GGBL7071C6

Product code	Description	Pack qty
GGBL7071C6	RJ45 CAT6 UTP single §	10
GGBL7071C6S	RJ45 CAT6 UTP single - display packaged §	10
GGBL7072C6	RJ45 CAT6 UTP twin §	10
GGBL7072C6S	RJ45 CAT6 UTP twin - display packaged §	10

TV outlets

Coaxial sockets



GGBL7010



GGBL7020



GGBL7030

Product code	Description	Pack qty
GGBL7010	TV/R	10
GGBL7010S	TV/R - display packaged	10
GGBL7020	Diplex TV-R/DAB	10
GGBL7020S	Diplex TV-R/DAB - display packaged	10
GGBL7030	Satellite "F" Type	10
GGBL7030S	Satellite "F" Type - display packaged	10

- **Standard of compliance:** BS 3041 (where applicable)
- **Mounting box:** 25mm deep for GGBL7010(S), GGBL7030(S); 35mm deep for GGBL7020(S)
- **Fixing screws:** M3.5 x 18 mm for GGBL7010(S) and GGBL7030(S); M3.5 x 25 mm for GGBL7020(S)
- **Plate dimensions:** 87 x 87mm

Combination plates

Quadplex combination



Product code	Description	Pack qty
GGBL7074	Quadplex TV-R/DAB & 2 x SAT	10
GGBL7074S	Quadplex TV-R/DAB & 2 x SAT - display packaged	10
GGBL707445510	Quadplex RJ45 CAT5e & TV return	5
GGBL707445510S	Quadplex RJ45 CAT5e & TV return - display packaged	5
GGBL707445511	Quadplex RJ45 CAT5e & RJ12	5
GGBL707445511S	Quadplex RJ45 CAT5e & RJ12 - display packaged	5
GGBL70746110	Quadplex BT secondary & TV return	5
GGBL70746110S	Quadplex BT secondary & TV return - display packaged	5

- **Standard of compliance:** BS EN 5733
- **Mounting box:** 35mm deep
- **Fixing screws:** M3.5 x 25mm
- **Plate dimensions:** 87 x 87mm (1 gang)
87 x 148.5mm (2 gang)

Triplex combination



Product code	Description	Pack qty
GGBL7081	Triplex TV-R/DAB & SAT	10
GGBL7081S	Triplex TV-R/DAB & SAT - display packaged	10
GGBL7081456	Triplex TV-R/DAB & RJ45 CAT6 UTP	5
GGBL7081456S	Triplex TV-R/DAB & RJ45 CAT6 UTP - display packaged	5

- **Standard of compliance:** BS5733
- **Dimensions:** 174 x 295mm
- **Mounting box:** GGBSB4724M (dimensions: 160 x 270 x 47mm depth)
- **Fixing screws:** M3.5 x 25mm
- **Plate dimensions:** 87 x 87mm (1 gang)
87 x 148.5mm (2 gang)
- Euro modules plates compatible with Schneider Electric euro modules.
- **Note:** modules from other suppliers may not be compatible, it is advised to check suitability.

Socket & media combination plate



Product code	Description	Pack qty
GGBL3020D4MP	2 x 2 gang 13A socket, 2 x 2 module euro outlets, quadplex, BT secondary & TV return	1

Frames, blank plates & accessories

Frames & surrounds

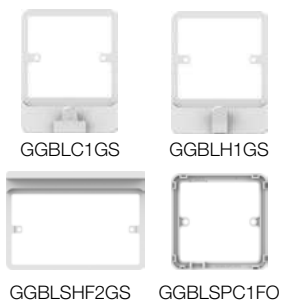

Product code	Description	Pack qty
GGBLSPC1FO	1 gang flex outlet frame	10
GGBLH1GS	1 gang surround with hook - display packaged	10
GGBLC1GS	1 gang surround with clip - display packaged	10
GGBLSHF2GS	2 gang surround with shelf - display packaged	10

- **Standard of compliance:** BS EN 5733
- **Fixing screws:** GGBLSPC1FO is supplied with cable clamp and fix screws M3.5 x 30 mm
- **Plate dimensions:** 87 x 87mm (1 gang)
87 x 148.5mm (2 gang)

Spacers & accessories



Product code	Description	Pack qty
GGBLSPC1	1 gang spacer	10
GGBLSPC1S	1 gang spacer - display packaged	10
GGBLSPC2	2 gang spacer	5
GGBLSPC2S	2 gang spacer - display packaged	10

Frames, blank plates & accessories continued

Blank plates & accessories



GGBL8010 GGBL8020



GGBLSIND

Product code	Description	Pack qty
GGBL8010	1 gang	10
GGBL8010S	1 gang - display packaged	10
GGBL8020	2 gang	5
GGBL8020S	2 gang - display packaged	10
GUMSCO	White moulded screw cap covers	100
GGBLSIND	LED indicators	5
USCREW50SS	M3.5 x 50mm screws	100
3746130	M3.5 x 25mm raised head machine screws	100

- **Standard of compliance:**
BS EN 5733
- **Fixing screws:**
M3.5 x 18mm (blank plates only)
- **Plate dimensions:**
87 x 87mm (1 gang)
87 x 148.5mm (2 gang)

Grid plates

88 x 88mm



GGBL01G GGBL02G

Product code	Description	Pack qty
GGBL01G	1 gang	5
GGBL02G	2 gang	5
GBG01	76 x 76 x 42mm flush mounted back box	1

- **Mounting box:**
42mm deep
- **Fixing screws:**
M3.5 x 30mm

88 x 148mm



GGBL04G

Product code	Description	Pack qty
GGBL03G	3 gang	5
GGBL04G	4 gang	5
GBG02	136 x 76 x 42mm flush mounted back box	1

156 x 156mm

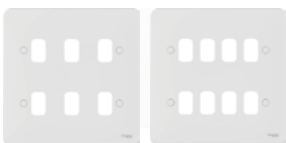

GGBL06G GGBL08G

Product code	Description	Pack qty
GGBL06G	6 gang	1
GGBL08G	8 gang	1
GBG03	136 x 136 x 42mm flush mounted back box	1

White moulded grid modules

Switch modules



GGBL102W



GGBLG2011

Product code	Description	Pack qty
GGBL102W	10AX 2 way	1
GGBL10IW	10AX intermediate	1
GGBL201W	20AX 1 way	1
GGBL202W	20AX 2 way	1
GGBL20DPW	20AX double-pole	1
GGBLG2011	20AX double-pole with neon	1

- **Standard of compliance:**
BS EN 60669-1 (switch modules)
BS 5733 (indicator modules)
BS EN 41003 (fused connection units)
- **Mounting box:**
42mm deep

White moulded grid modules

20AX DP printed switch modules

Product code	Description	Pack qty
GGBL20DPMWW	Printed microwave	1
GGBL20DPCHW	Printed cooker hood	1
GGBL20DPDWW	Printed dishwasher	1
GGBL20DPFZW	Printed freezer	1
GGBL20DPWMW	Printed washing machine	1
GGBL20DPTDW	Printed tumble dryer	1
GGBL20DPHTW	Printed heater	1
GGBL20DPOVW	Printed oven	1
GGBL20DPEFW	Printed extractor fan	1
GGBL20DPFAW	Printed fan	1
GGBL20DPFFZW	Printed fridge freezer	1
GGBL20DPFRW	Printed fridge	1
GGBL20DPHOW	Printed hob	1
GGBL20DPWBO	Printed boiler	1
GGBL20DPWBOT	Printed boost	1
GGBL20DPWMVHR	Printed mvhr	1
GGBL20DPWWCL	Printed wine cooler	1

- **Standard of compliance:**
BS EN 60669-1
(switch modules)
BS 5733
(indicator modules)
BS EN 41003 (fused connection units)
- **Mounting box:**
42mm deep

Retractive switch modules



GGBL202OCW

Product code	Description	Pack qty
GGBL102RW	10AX 2 way	1
GGBL202OCW	10AX 2 way & centre off	1
GGBL2020W	20AX 2 way centre off & on	1

Key switch modules



GGBL202KEPWPW

Product code	Description	Pack qty
GGBL202KEPWPW	20AX 2 way	1
GGBL20DPKWPW	20AX double-pole	1
GGBL202KEPWPWEL	20AX 2W Key Switch Grid / EMG LTG	1
GGBL20DPKWPWEL	20AX 2W DP Key SW Grid / EMG LTG	1

Fused connection unit, USB charger & blank modules



GGBL13FCUWPW



GGBLBW

Product code	Description	Pack qty
GGBL13FCUWPW	13A fused connection unit	1
GGBLE7004	USB charger	1
GGBLBW	Blank	1

White moulded grid modules continued

Indicator modules



Product code	Description	Pack qty
GGBLINDWG	Green indicator	1
GGBLINDWR	Red indicator	1
GGBLINDWO	Orange indicator	1

- **Standard of compliance:**
BS EN 60669-1 (switch modules)
BS 5733 (indicator modules)
BS EN 41003 (fused connection units)
- **Mounting box:**
42mm deep

Euro plates & modules

Euro plates



Product code	Description	Pack qty
GGBL8050	1 gang 1 module	10
GGBL8060	1 gang 2 module	10
GGBL8080	2 gang 4 module	5

- **Mounting box:**
35mm deep
- **Fixing screws:**
M3.5 x 30mm
- **Plate dimensions:**
87 x 87mm (1 gang)
87 x 148.5mm (2 gang)
- Euro modules plates compatible with Schneider Electric euro modules.
- **Note:** modules from other suppliers may not be compatible, it is advised to check suitability.

25 x 50mm euro modules



Product code	Description	Pack qty
GUE7011W	Single IEC coax (female)	1
GUE7012W	Single IEC coax (male)	1
GUE7030W	Single F type sat	1
GUE7061W	BT master telephone	1
GUE7062WK	BT secondary telephone	1
GUE7071W	RJ45 CAT5e (not screened)	1
GUE7072W	RJ45 CAT6 (not screened)	1
GUE7051W	RJ11 modem	1
GUE7075W	VGA	1
GUE7091W	LexCom Performance outlet	8
GUE7000W	2 x Phono socket	1
GUE7001W	2 x Loudspeaker socket	1
GUE8010W	Blank module	5
GUE7073W	1A USB charger	1

50 x 50mm euro modules



GUE7010W

Product code	Description	Pack qty
GUE7010W	TV/FM diplexer	1
GUE7040W	TV/Sat diplexer	1
GUE7081W	TV/FM/Sat triplexer	1
GUE7082W	TV/FM/Sat1/Sat2 quadplexer	1
GUE7020W	HDMI	1
GUE7074W	2 x 1A USB charger	1
GGBLGUE7078*	American power socket	1
GUE7076*	Brush outlet	1
GUE7077*	5A round pin socket	1
GGBGUE7079*	European socket	1

- **MTO products for projects only, leadtime to be confirmed at time of ordering**

Surface pattresses

1 gang



GGBL9116

GGBL9147

Product code	Description	Pack qty
GGBL9116	1 gang 16mm	10
GGBL9116S	1 gang 16mm - display packaged	10
GGBL9125	1 gang 25mm	10
GGBL9125S	1 gang 25mm - display packaged	10
GGBL9147	1 gang 40mm	10
GGBL9147S	1 gang 40mm - display packaged	10

- **Standard of compliance:** BS 5733
- **Technical notes:** All supplied complete with earth terminals.

Surface 2 gang



GGBL9225



GGBL9D25



GGBL9247

Product code	Description	Pack qty
GGBL9225	2 gang 25mm	5
GGBL9225S	2 gang 25mm - display packaged	5
GGBL9D25	2 gang dual 25mm	5
GGBL9D25S	2 gang dual 25mm - display packaged	5
GGBL9247	2 gang 40mm	5
GGBL9247S	2 gang 40mm - display packaged	5

Architrave



GGBL9216A

Product code	Description	Pack qty
GGBL9116A	1 gang 16mm	10
GGBL9216A	2 gang 16mm	10

Flush galvanised steel boxes

16mm deep



SB161

Product code	Description	Pack qty
SB161	1 gang	20

25mm deep



SB252

Product code	Description	Pack qty
SB251	1 gang	10
SB252	2 gang	10

35mm deep



SB351

Product code	Description	Pack qty
SB351	1 gang	10
SB352	2 gang	5

47mm deep



SB472

Product code	Description	Pack qty
SB471	1 gang	10
SB472	2 gang	4

- **Standard of compliance:**
BS 4662

- **Technical notes:**
Supplied with earth terminal and screw.

Supplied with fixed and adjustable lugs.

Fitted with selection of 20mm knockouts in sides and back.





Exclusive

Meeting all of your needs

The Exclusive range of wiring accessories offers the dependability that you need along with increased flexibility in applications, whether those are installations in the residential and commercial space or in outdoor and industrial environments.



Square edge white moulded

This comprehensive white moulded range will offer everything that your customers need in a traditional wiring accessory. With its classic, square edge design, the Exclusive white moulded range will suite well with existing installations and is sure to please again and again.



Metal clad

Looking for stronger stuff? The Exclusive metal clad range of wiring accessories offers an incredibly robust solution for industrial applications, with two finish options - Grey and Silver Grey.

Exclusive square edge white moulded

This highly successful Exclusive square edge range of white moulded wiring accessories maintains superb quality, with an easy-to-install technical specification, for exceptional value for money.

Optional cable outlet facility provides the choice of either surface or flush cable access

Full 10AX plate switch rating for fluorescent and inductive loads

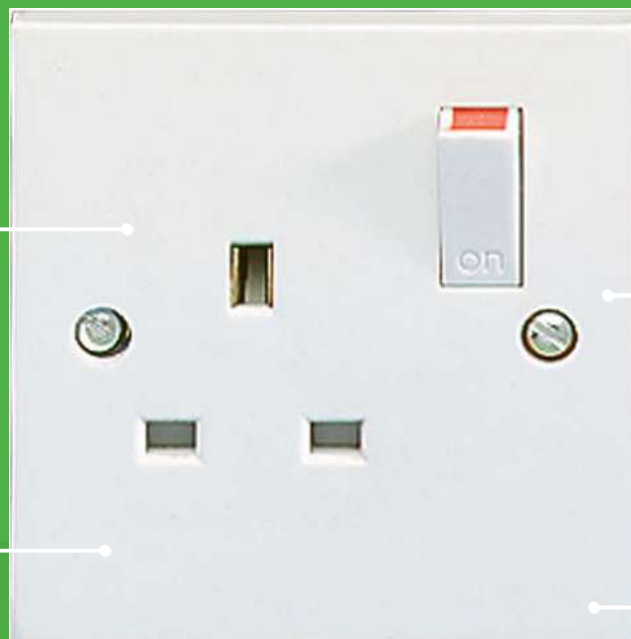

50A rated switches for operating appliances with higher current ratings, such as heaters, cookers and commercial refrigerating units

Timeless and traditional plate profile, with generous 9mm plate depth

Double pole sockets provide both easy access to connections as well as twin earth terminals for high integrity earthing

Residual current devices with active and passive controls offer added safety in the event of lost power:

- **Passive Latching:** Designed for food freezers or garden water feature pumps, ensuring that contacts will stay closed during loss of power so that RCD does not need re-setting when the circuit is restored.
- **Active / non-latching:** Designed for lawnmowers or power tools, the RCD will tip on loss of power and requires manual resetting when the circuit is to be re-energised.

Converta Socket Outlets

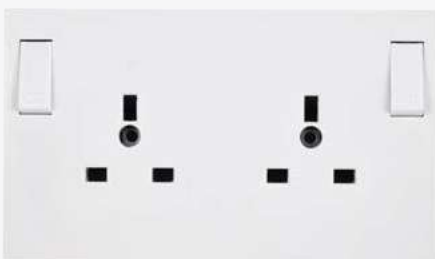

A converta socket outlet is an ideal retrofit solution for existing installations. The device allows single to double conversion of standard flush-mounted wiring accessories without the need for additional cabling or chasing.

- Allows 2 gang socket to fit 1 gang steel back box
- Quick and easy replacement, saving time and money
- Reduces the need for redecorating



Socket outlets

13A unswitched



GSKT1G



GSKT2G

Product code	Description	Pack qty
GSKT1G	1 gang	10
GSKT2G	2 gang	5

13A switched



GSKTSW1G



GSKTSW2G2

Product code	Description	Pack qty
GSKTSW1G	1 gang single-pole	10
GSKTSWDP1G	1 gang double-pole	10
GSKTSW2G2	2 gang single-pole	5
GSKTSWDP2G	2 gang double-pole	5
GSKTSW3G	3 gang single-pole with fuse	5

13A double-pole switched with outboard rockers



GSKTSWDPOB2G



GSKTSWDP1G2G

Product code	Description	Pack qty
GSKTSWDPOB2G	2 gang	5
GSKTSWDP1G2G	1-2 gang converta	5

Round pin



GSKT2A1G



GSKT5A1G

Product code	Description	Pack qty
GSKT2A1G	2A unswitched	10
GSKT5A1G	5A unswitched	10

Double-pole 30mA RCD protected



GPRCDSKT2G

Product code	Description	Pack qty
LSKT1GR	1 gang unswitched - active control	1
GPRCDSKT1G	1 gang switched - passive control	1
LSKT2GR	2 gang unswitched - active control	1
LSKT2GRP	2 gang unswitched - passive control	1
GPRCDSKT2G	2 gang switched - passive control	1

- **Standard of compliance:**
BS 1363 (13A)
BS 546 (round pin)
BS 7288 (RCD)
- **Mounting box:**
Minimum 25mm deep
- **Fixing screws:**
M3.5 x 30mm
- **Plate dimensions:**
86 x 86mm (1 gang)
86 x 146mm (2 gang)
- **Technical notes:**
Active control - device will fail safe in the event of loss of supply. Suitable for domestic use.

Passive control - device will only trip in the event of a fault. Suitable for freezers and commercial applications.

All 2 gang sockets include twin earth terminals as standard, enabling high integrity earthing.

Plate switches

10AX 1 gang



GSW1G2W

Product code	Description	Pack qty
GSW1G1W	1 gang 1 way	10
GSW1G2W	1 gang 2 way	10
GSWINT	Intermediate	10

- **Standard of compliance:**
BS EN 60669-1
BS EN 60947-3
(GSWISO2)
BS 3676
(GSWTPS)

- **Mounting box:**
16mm deep (1-2 gang)
25mm deep (3-6 gang)

- **Fixing screws:**
M3.5 x 18mm

- **Plate dimensions:**
86 x 86mm (1-3 gang)

86 x 146mm (4 gang)

33 x 86mm (1 gang
architrave)33 x 148mm (2 gang
architrave)

10A 1 gang 2 way retractive



GSW1G2WRP

Product code	Description	Pack qty
GSW1G2WR	1 gang 2 way	10
GSW1G2WRP	1 gang 2 way printed with press	10

10AX multi gang



GSW2G2W



GSW3G2W



GSW4G2W

Product code	Description	Pack qty
GSW2G2W	2 gang 2 way	10
GSW3G2W	3 gang 2 way	10
GSW4G2W	4 gang 2 way	10

10A triple pole isolator



GSWTPS



GSWISO2

Product code	Description	Pack qty
GSWTPS	Triple pole switch	10
GSWISO2	3 pole lockable isolator	10

10AX architrave



GSWA1G2W

Product code	Description	Pack qty
GSWA1G2W	1 gang 2 way	10

Dimmer switches

1 gang



GD1G2WC

Product code	Description	Pack qty
GD1G1W	60-250W 1 way mains	1
GD1G2WC	250W/VA 2 way mains & low voltage	1
GD1G2W4C	400W/VA 2 way mains & low voltage	1

- **Standard of compliance:** BS EN 60669-2-1
- **Mounting box:** 16mm (GD1G1W) 25mm deep
- **Fixing screws:** M3.5 x 30mm
- **Plate dimensions:** 86 x 86mm (1 gang) 86 x 146mm (2 gang)
- **Technical notes:** Not suitable for dimming LED or CFL lighting.

2 gang



GD2G2WC

Product code	Description	Pack qty
GD2G2WC	250W/VA 2 way mains & low voltage	1

Control switches & flex outlet plates

20AX DP 1 gang switched



GSWDPN20A

Product code	Description	Pack qty
GSWDP20A	1 gang	10
GSWDPN20A	1 gang with neon	10

- **Standard of compliance:** BS EN 60669-1
- **Mounting box:** 25mm deep
- **Fixing screws:** M3.5 x 30mm
- **Plate dimensions:** 86 x 86mm

20AX DP 1 gang switched with flex outlet



GSWDP20AFO

Product code	Description	Pack qty
GSWDP20AFO	1 gang	10

20AX DP 1 gang switched with neon & flex outlet



GSWDPN20AFO

Product code	Description	Pack qty
GSWDPN20AFO	1 gang	10

Flex outlet plates



GSFOPLATE



GFOPLATE

Product code	Description	Pack qty
GSFOPLATE	25A side entry	10
GFOPLATE	20A front entry	10

- **Standard of compliance:** BS 5733
- **Mounting box:** 25mm deep
- **Fixing screws:** M3.5 x 30mm
- **Plate dimensions:** 86 x 86mm

Fused connection units

Unswitched



GSPUR3A

GSPUR

Product code	Description	Pack qty
GSPUR3A	3A	10
GSPUR	13A	10
GNSPUR	13A with neon	10

- **Standard of compliance:**
BS 1363
- **Mounting box:**
25mm deep
- **Fixing screws:**
M3.5 x 30mm
- **Plate dimensions:**
86 x 86mm
- **Technical note:**
Optional flex outlet facility at the base of the front plate

13A DP switched with optional flex outlet



GSWSPUR

Product code	Description	Pack qty
GSWSPUR	13A DP	10

13A DP switched with neon & optional flex outlet



GSWNSPUR

Product code	Description	Pack qty
GSWNSPUR	13A DP	10

- **Standard of compliance:**
BBS 1363
BS 7288 (RCD)
- **Mounting box:**
25mm deep
- **Fixing screws:**
M3.5 x 30mm
- **Plate dimensions:**
86 x 86mm

Double-pole 30mA RCD protected



GPRCDFCU

Product code	Description	Pack qty
GPRCDFCU	Unswitched - passive control	1

High current switches

50A DP switches



GCKRN50A



GCKR50A2G

Product code	Description	Pack qty
GCKR50A	1 gang	5
GCKRN50A	1 gang with neon	5
GCKR50A2G	2 gang	5
GCKRN50A2G	2 gang with neon	5

- **Standard of compliance:**
BS EN 60669-1 (switches)
BS 4177 (cooker control units)
BS 5733
- **Mounting box:**
40mm deep
- **Fixing screws:**
M3.5 x 30mm
- **Plate dimensions:**
86 x 86mm (1 gang)
146 x 86mm (2 gang)

45A cooker control unit with 13A switched socket



G45ACCUN

Product code	Description	Pack qty
G45ACCU	45A cooker control unit	1
G45ACCUN	45A cooker control unit with neons	1

Cooker connection unit



G45CX

Product code	Description	Pack qty
G45CX	Cooker connection unit	10

Shaver socket

115/230V dual voltage



GSHVSKT

Product code	Description	Pack qty
GSHVSKT	Dual voltage 115/230V socket	1

- **Standard of compliance:**
BS EN 61558-2-5
BS 646 (fuse)
- **Mounting box:**
40mm deep
- **Fixing screws:**
M3.5 x 30mm
- **Plate dimensions:**
146 x 86mm

Telephone & data outlets

Telephone outlets



GTELRJ11

GTELMAS

Product code	Description	Pack qty
GTELRJ11	RJ11 outlet	10
GTELMAS	BT master	10
GTELSEC	BT secondary	10

- **Standard of compliance:** BS EN 41003
- **Mounting box:** 25mm deep
- **Fixing screws:** M3.5 x 30mm
- **Plate dimensions:** 86 x 86mm

RJ45 CAT5e UTP



GTELRJ45

Product code	Description	Pack qty
GTELRJ45	RJ45 CAT5e UTP	10

TV outlets

Coaxial sockets



GSKTCOAX

GSKTCOAX2G

Product code	Description	Pack qty
GSKTCOAX	Single direct connection TV	10
GSKTCOAX2G	Twin direct connection TV	10

- **Standard of compliance:** BS 3041 (where applicable)
- **Mounting box:** 25mm deep
- **Fixing screws:** M3.5 x 30mm
- **Plate dimensions:** 86 x 86mm

Blank plates & accessories

Blank plates & machine screws



GBLANK1G

GBLANK2G

Product code	Description	Pack qty
GBLANK1G	1 gang	10
GBLANK2G	2 gang	5
USCREW50SS	M3.5 x 50mm screws	100
3746130	M3.5 x 25mm raised head machine screws	100

- **Standard of compliance:** BS EN 5733
- **Fixing screws:** M3.5 x 30mm
- **Plate dimensions:** 86 x 86mm (1 gang)
86 x 146mm (2 gang)

Euro modular plates & modules

Euro plates



Product code	Description	Pack qty
GEURO1	1 gang 1 module	10
GEURO2	1 gang 2 module	10
GEURO4	2 gang 4 module	5

- **Mounting box:**
35mm deep
- **Fixing screws:**
M3.5 x 30mm
- **Plate dimensions:**
86 x 86mm (1 gang)
86 x 146mm (2 gang)

25 x 50mm euro modules



Product code	Description	Pack qty
GUE7011W	Single IEC coax (female)	1
GUE7012W	Single IEC coax (male)	1
GUE7030W	Single F type sat	1
GUE7061W	BT master telephone	1
GUE7062WK	BT secondary telephone	1
GUE7071W	RJ45 CAT5e (not screened)	1
GUE7072W	RJ45 CAT6 (not screened)	1
GUE7051W	RJ11 modem	1
GUE7075W	VGA	1
GUE7091W	LexCom Performance outlet	8
GUE7000W	2 x Phono socket	1
GUE7001W	2 x Loudspeaker socket	1
GUE8010W	Blank module	5
GUE7073W	1A USB charger	1

50 x 50mm euro modules



Product code	Description	Pack qty
GUE7010W	TV/FM diplexer	1
GUE7040W	TV/Sat diplexer	1
GUE7081W	TV/FM/Sat triplexer	1
GUE7082W	TV/FM/Sat1/Sat2 quadplexer	1
GUE7020W	HDMI	1
GUE7074W	2 x 1A USB charger	1
GGBLGUE7078*	American power socket	1
GUE7076*	Brush outlet	1
GUE7077*	5A round pin socket	1
GGBGUE7079*	European socket	1

- **MTO products for projects only, leadtime to be confirmed at time of ordering**

Surface pattresses

1 gang



GPAT1G16

Product code	Description	Pack qty
GPAT1G16	1 gang 16mm	10
GPAT1G25	1 gang 25mm	10
GPAT1G47	1 gang 40mm	10

2 gang



GPAT2G25

Product code	Description	Pack qty
GPAT2G25	2 gang 25mm	5
GPATDG25	2 gang dual 25mm	10
GPAT2G47	2 gang 40mm	5

Architrave



GPAT1G16A

Product code	Description	Pack qty
GPAT1G16A	1 gang 16mm	20

Converter



GPAT2GC25



GPAT3G25

Product code	Description	Pack qty
GPAT2GC25	1-2 gang 25mm	5
GPAT3G25	1-3 gang 25mm	5

- **Technical notes:**
GPAT3G25 is designed for us with GSKTSW3G.

Flush galvanised steel boxes

16mm deep



SB161

Product code	Description	Pack qty
SB161	1 gang	20

25mm deep



SB252

Product code	Description	Pack qty
SB251	1 gang	10
SB252	2 gang	10

35mm deep



SB351

Product code	Description	Pack qty
SB351	1 gang	10
SB352	2 gang	5

47mm deep



SB472

Product code	Description	Pack qty
SB471	1 gang	10
SB472	2 gang	4

- **Standard of compliance:**
BS 4662

- **Technical notes:**
Supplied with earth terminal and screw.

Supplied with fixed and adjustable lugs.

Fitted with selection of 20mm knockouts in sides and back.





Exclusive
Metal clad

Exclusive Metal clad

Our Exclusive metal clad range has been built to perform. The strong, industrial design supported by a robust technical specification makes this range the perfect choice for a variety of commercial and public buildings.

Popular trends in the domestic market for modern loft style interiors also provide the perfect backdrop for this range which is available in either grey or silver grey finishes.

Boxes are supplied with a full selection of 20mm knockouts

Choice of grey and silver grey finishes; ideal for commercial spaces and modern domestic interiors

Tough and impact resistant

50A rated plate switches for switching appliances with higher current ratings, such as heaters, cookers and commercial refrigerating units

All products are supplied complete with 42mm deep surface mounting box in matching finish

Finish Selection

The Exclusive Metal Clad range is available in Silver Grey or Grey finishes



Socket outlets

13A 1 gang unswitched



GMC131S

Product code	Description	Pack qty
GMC131S	Grey	10
GMCS131S	Silver Grey	10

13A 2 gang unswitched

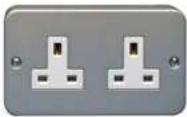

GMC132S

Product code	Description	Pack qty
GMC132S	Grey	5
GMCS132S	Silver Grey	5

13A 1 gang single-pole switched



GMC131SS

Product code	Description	Pack qty
GMC131SS	Grey	10
GMCS131SS	Silver Grey	10

13A 2 gang single-pole switched



GMC132SS

Product code	Description	Pack qty
GMC132SS	Grey	5
GMCS132SS	Silver Grey	5

13A 2 gang single-pole switched with outboard rockers



GU3631GMC

Product code	Description	Pack qty
GU3631GMC	Grey	5

5A round pin unswitched



GMC51S

Product code	Description	Pack qty
GMC51S	Grey	10
GMCS51S	Silver Grey	10

1 gang double-pole 30mA RCD protected - active control



LMCSKT1GR

Product code	Description	Pack qty
LMCSKT1GR	Grey	1

- **Standard of compliance:**
BS 1363 (13A)
BS 546 (round pin)
BS 7288 (RCD)
- **Mounting box:**
40mm deep (back box supplied)
- **Fixing screws:**
M3.5 x 30mm
- **Plate dimensions:**
79 x 79 x 42mm (1 gang)

79 x 139 x 42mm (2 gang)

92 x 145 x 49mm (RCDs)
- **Technical notes:**
LMCSKT1GR requires a 2 gang back box.

Active control consists of an electronic latch, which will require resetting in the event of a loss of supply. Particularly useful for domestic use.

Passive control - device will only trip in the event of a fault. Suitable for freezers and commercial applications.

1 gang double-pole 30mA RCD protected switched - passive control



GMCPRCDSKT1G

Product code	Description	Pack qty
GMCPRCDSKT1G	Grey	1

2 gang double-pole 30mA RCD protected - active control



LMCSKT2GR

Product code	Description	Pack qty
LMCSKT2GR	Grey	1

2 gang double-pole 30mA RCD protected unswitched - passive control



LMCSKT2GRP

Product code	Description	Pack qty
LMCSKT2GRP	Grey	1

2 gang double-pole 30mA RCD protected switched - passive control



GMCPRCDSKT2G

Product code	Description	Pack qty
GMCPRCDSKT2G	Grey	1

Plate switches

10AX 1 gang 2 way



GMC1012

Product code	Description	Pack qty
GMC1012	Grey	10
GMCS1012	Silver Grey	10

- **Standard of compliance:**
BS EN 60669-1
- **Mounting box:**
40mm deep (back box supplied)
- **Plate dimensions:**
79 x 79 x 42mm

10AX 1 gang intermediate



GMCINT

Product code	Description	Pack qty
GMCINT	Grey	10
GMCSINT	Silver Grey	10

Plate switches continued

10AX 2 gang 2 way



GMC1022

Product code	Description	Pack qty
GMC1022	Grey	10
GMCS1022	Silver Grey	10

- **Standard of compliance:** BS EN 60669-1
- **Mounting box:** 40mm deep (back box supplied)
- **Plate dimensions:** 79 x 79 x 42mm

10AX 3 gang 2 way



GMC1032

Product code	Description	Pack qty
GMC1032	Grey	10
GMCS1032	Silver Grey	10

Control switches

20AX double-pole 1 gang switched



GMC20S

Product code	Description	Pack qty
GMC20S	Grey	10
GMCS20S	Silver Grey	10

- **Standard of compliance:** BS EN 60669-1
- **Mounting box:** 40mm deep (back box supplied)
- **Plate dimensions:** 79 x 79 x 42mm

20AX double-pole 1 gang switched with neon



GMC20SN

Product code	Description	Pack qty
GMC20SN	Grey	10
GMCS20SN	Silver Grey	10

Fused connection units

13A unswitched



GMC13SP

Product code	Description	Pack qty
GMC13SP	Grey	10
GMCS13SP	Silver Grey	10

- **Standard of compliance:** BS 1363
- **Mounting box:** 40mm deep (back box supplied)
- **Plate dimensions:** 79 x 79 x 42mm

13A unswitched with neon



GMC13SPN

Product code	Description	Pack qty
GMC13SPN	Grey	10
GMCS13SPN	Silver Grey	10

13A unswitched with flex outlet



GMC13SPF

Product code	Description	Pack qty
GMC13SPF	Grey	10
GMCS13SPF	Silver Grey	10

13A DP unswitched with neon & flex outlet



GMC13SPNF

Product code	Description	Pack qty
GMC13SPNF	Grey	10
GMCS13SPNF	Silver Grey	10

13A double-pole switched



GMC13SSP

Product code	Description	Pack qty
GMC13SSP	Grey	10
GMCS13SSP	Silver Grey	10

13A double-pole switched with neon



GMC13SSPN

Product code	Description	Pack qty
GMC13SSPN	Grey	10
GMCS13SSPN	Silver Grey	10

13A double-pole switched with flex outlet



GMC13SSPF

Product code	Description	Pack qty
GMC13SSPF	Grey	10
GMCS13SSPF	Silver Grey	10

13A double-pole switched with neon & flex outlet



GMC13SSPNF

Product code	Description	Pack qty
GMC13SSPNF	Grey	10
GMCS13SSPNF	Silver Grey	10

Double-pole 30mA RCD protected - passive control



GMCPRCDFCU

Product code	Description	Pack qty
GMCPRCDFCU	Grey	1

- **Standard of compliance:** BS 1363
- **Mounting box:** 40mm deep (back box supplied)
- **Plate dimensions:** 79 x 79 x 42mm
- **Technical notes:** Active control consists of an electronic latch, which will require resetting in the event of a loss of supply. Particularly useful for domestic use.
- **Passive control - device will only trip in the event of a fault.** Suitable for freezers and commercial applications.

High current switches

50A 1 gang double-pole switch



GMC50S

Product code	Description	Pack qty
GMC50S	Grey	10
GMCS50S	Silver Grey	10

- **Standard of compliance:**
BS EN 60669-1
- **Mounting box:**
40mm deep (back box supplied)
- **Plate dimensions:**
79 x 79 x 42mm
(1 gang)

139 x 79 x 42mm
(2 gang)

50A 1 gang double-pole switch with neon



GMC50SN

Product code	Description	Pack qty
GMC50SN	Grey	10

50A 2 gang double-pole switch with neon



GMC50S2N

Product code	Description	Pack qty
GMC50S2N	Grey	5
GMCS50S2N	Silver Grey	5

Blank plates

1 gang



GMCB1

Product code	Description	Pack qty
GMCB1	Grey	10
GMCSB1	Silver Grey	10

2 gang



GMCB2

Product code	Description	Pack qty
GMCB2	Grey	5
GMCSB2	Silver Grey	5

- **Standard of compliance:**
BS EN 5733
- **Mounting box:**
40mm deep (back box supplied)
- **Plate dimensions:**
79 x 79 x 42mm
(1 gang)
79 x 139 x 42mm
(2 gang)

Grid plates

1 gang 88 x 88mm



GUG01GMC

Product code	Description	Pack qty
GUG01GMC	Grey	1
GBG01	Grey 76 x 76 x 42mm back box with knockouts	1
GUG01GSMC	Silver Grey	1
GBGS01	Silver Grey 76 x 76 x 42mm back box with knockouts	1
GBG01P	Grey 76 x 76 x 42mm back box without knockouts	1

- **Standard of compliance:** BS 5733
- **Mounting box:** 40mm deep
- **Technical notes:** All grid plates are supplied with the appropriate number of mounting frames.

Back box needs to be ordered separately.

2 gang 88 x 88mm



GUG02GMC

Product code	Description	Pack qty
GUG02GMC	Grey	1
GBG01	Grey 76 x 76 x 42mm back box with knockouts	1
GUG02GSMC	Silver Grey	1
GBGS01	Silver Grey 76 x 76 x 42mm back box with knockouts	1
GBG01P	Grey 76 x 76 x 42mm back box without knockouts	1

3 gang 88 x 148mm

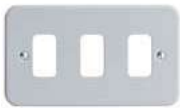

GUG03GMC

Product code	Description	Pack qty
GUG03GMC	Grey	1
GBG02	Grey 7136 x 76 x 42mm back box with knockouts	1
GUG03GSMC	Silver Grey	1
GBGS02	Silver Grey 136 x 76 x 42mm back box with knockouts	1
GBG02P	Grey 76 x 76 x 42mm back box without knockouts	1

4 gang 88 x 148mm



GUG04GMC

Product code	Description	Pack qty
GUG04GMC	Grey	1
GBG02	Grey 7136 x 76 x 42mm back box with knockouts	1
GUG01GSMC	Silver Grey	1
GBGS02	Silver Grey 136 x 76 x 42mm back box with knockouts	1
GBG02P	Grey 76 x 76 x 42mm back box without knockouts	1

6 gang 156 x 156mm



GUG06GMC

Product code	Description	Pack qty
GUG06GMC	Grey	1
GBG03	Grey 136 x 136 x 42mm back box with knockouts	1
GUG06GSMC	Silver Grey	1
GBGS03	Silver Grey 136 x 136 x 42mm back box with knockouts	1

8 gang 156 x 156mm



GUG08GMC

Product code	Description	Pack qty
GUG08GMC	Grey	1
GBG03	Grey 136 x 136 x 42mm back box with knockouts	1
GUG08GSMC	Silver Grey	1
GBGS03	Silver Grey 136 x 136 x 42mm back box with knockouts	1

Grid plates continued

9 gang 216 x 156mm



GUG09GMC

Product code	Description	Pack qty
GUG09GMC	Grey	1
GBG04S	Grey 202 x 136 x 42mm back box	1
GUG09GSMC	Silver Grey	1
GBGS04S	Silver Grey 202 x 136 x 42mm back box	1

12 gang 216 x 156mm



GUG12GMC

Product code	Description	Pack qty
GUG12GMC	Grey	1
GBG04S	Grey 202 x 136 x 42mm back box	1
GUG12GSMC	Silver Grey	1
GBGS04S	Silver Grey 202 x 136 x 42mm back box	1

18 gang 398 x 156mm



GUG18GMC

Product code	Description	Pack qty
GUG18GMC	Grey	1
GBG06S	Grey 334 x 136 x 42mm back box	1
GUG18GSMC	Silver Grey	1
GBGS06S	Silver Grey 334 x 136 x 42mm back box	1

24 gang 398 x 156mm



GUG24GMC

Product code	Description	Pack qty
GUG24GMC	Grey	1
GBG06S	Grey 334 x 136 x 42mm back box	1
GUG24GSMC	Silver Grey	1
GBGS06S	Silver Grey 334 x 136 x 42mm back box	1

- **Standard of compliance:**
BS 5733
- **Mounting box:**
40mm deep
- **Technical notes:**
All grid plates are supplied with the appropriate number of mounting frames.

Back box needs to be ordered separately.

White moulded grid modules

Switch modules



Switch modules



GUG102W

Product code	Description	Pack qty
GUG101W	10AX 1 way	1
GUG102W	10AX 2 way	1
GUG10IW	10AX intermediate	1
GUG201W	20AX 1 way	1
GUG202W	20AX 2 way	1
GUG20DPW	20AX DP	1

- **Standard of compliance:**
BS EN 60669-1
(switch modules)
BS 5733
(indicator modules)

20AX double-pole printed switch modules



GUG20DPMWW



GUG20DPHTW



GUG20DPHOW

Product code	Description	Pack qty
GUG20DPMWW	20AX double-pole printed microwave	1
GUG20DPCHW	20AX double-pole printed cooker hood	1
GUG20DPDWW	20AX double-pole printed dishwasher	1
GUG20DPFZW	20AX double-pole printed freezer	1
GUG20DPWMW	20AX double-pole printed washing machine	1
GUG20DPTDW	20AX double-pole printed tumble dryer	1
GUG20DPHTW	20AX double-pole printed heater	1
GUG20DPWDYW	20AX double-pole printed washer dryer	1
GUG20DPOVW	20AX double-pole printed oven	1
GUG20DPBOW	20AX double-pole printed boiler	1
GUG20DPWDW	20AX double-pole printed waste disposal	1
GUG20DPEFW	20AX double-pole printed extractor fan	1
GUG20DPFAW	20AX double-pole printed fan	1
GUG20DPFFZW	20AX double-pole printed fridge freezer	1
GUG20DPFRW	20AX double-pole printed fridge	1
GUG20DPHOW	20AX double-pole printed hob	1

Retractive switch modules

GUG202OCW,
GUG102RW,
GUG2020W

Product code	Description	Pack qty
GUG202OCW	6AX 2 way & centre off	1
GUG102RW	10AX 2 way	1
GUG2020W	20AX 2 way on & off	1

Blank & indicator modules



GUGBW



GUGINDWG



GUGINDWO

Product code	Description	Pack qty
GUGBW	Blank	1
GUGINDWG	Green indicator	1
GUGINDWR	Red indicator	1
GUGINDWO	Orange indicator	1

White painted metal grid modules

Key switch modules



GUG20DPKWPW & GUG202KWPW



GUG202KELWPW

Product code	Description	Pack qty
GUG20DPKWPW	20AX DP	1
GUG20DPKELWPW	20AX DP printed TEST EMG LTG	1
GUG202KWPW	20AX 2 way	1
GUG202KELWPW	20AX 2 way printed TEST EMG LTG	1

• **Standard of compliance:**
 BS EN 60669-1
 (key switches)
 BS EN 41003
 BS EN 3041

Communication modules



GUGTELMWPW & GUGTELSWPW



GUGRJ45WPW



GUGCOWPW

Product code	Description	Pack qty
GUGTELMWPW	BT master	1
GUGTELSWPW	BT secondary	1
GUGRJ11WPW	RJ11	1
GUGRJ45WPW	RJ45 CAT5e	1
GUGCOWPW	TV/FM coaxial	1
GUGSATWPW	Satellite	1

Fused connection unit & flex outlet



GUG13FCUWPW



GUG16COWPW

Product code	Description	Pack qty
GUG13FCUWPW	13A fused connection unit	1
GUG16COWPW	Flex outlet (10mm diameter)	1





T2 Ceiling

T2 Ceiling Range

The highly successful T2 range of ceiling accessories offers superb quality and easy to install technical specification that has established this design as a firm favourite.



Fully coordinated, incorporating a large footprint for easy installation

Raised mounting feet to assist installation on uneven surfaces

Ample wiring space with four knockouts

Clear terminals for easy visibility and installation

Specification Highlights



Batten holders and ceiling roses share a common base assembly with 50.8mm fixing centres



Pendant lamp holder has integral cord grip to prevent cable pull on terminals



Full complementary accessories including dry lining and conduit boxes

Batten lamp holders

Pre-wired straight



GBAT

Product code	Description	Pack qty
GBAT	Black base	10
GBATC	Clear base	10

Pre-wired angled



GABAT

Product code	Description	Pack qty
GABAT	Black base	10
GABATC	Clear base	10

3 terminal straight



GEBAT

Product code	Description	Pack qty
GEBAT	Black base	10

• **Standard of compliance:**
BS EN 61184

• **Technical notes:**
Large capacity earth terminals.

Ample wiring space with four knockouts.

Clear terminals for easy visibility and installation.

Pendant sets

Pre-wired 6 inch urea



GPEND62

Product code	Description	Pack qty
GPEND62	Black base	10
GPEND6C2	Clear base	10

Pre-wired 9 inch urea



GPEND92

Product code	Description	Pack qty
GPEND92	Black base	10
GPEND9C2	Clear base	10

• **Standard of compliance:**
BS EN 60598-2-1
BS EN 61184

• **Technical notes:**
CFL lamps not supplied with energy saving pendants.

High heat resistance to BS EN 61184:1995.

Energy saving 6 inch



GESPEND613

Product code	Description	Pack qty
GESPEND613	13W	1
GESPEND618	18W	1

Ceiling roses

Urea



GRO

Product code	Description	Pack qty
GRO	Black base	10
GROC	Clear base	10

- **Standard of compliance:** BS EN 61184
- **Technical notes:** Urea base centres are 50.8mm.

Polycarbonate



E93WE

Product code	Description	Pack qty
E93WE	Ceiling rose	1

Lamp holders

With intergral cord grip



GLHC

Product code	Description	Pack qty
GLHC	With intergral cord grip	20

- **Standard of compliance:** BS EN 61184

Ceiling switches

6AX



GSWPULL6

Product code	Description	Pack qty
GSWPULL6	1 way	10
GSWPULL62	2 way	10

- **Standard of compliance:** BS EN 60669-1
- **Technical notes:** All switches supplied with 1.5m white nylon cord.

50A 1 way



GSWPULL50

Product code	Description	Pack qty
GSWPULL50	1 way	10
GSWPULL50N	1 way with neon	10

- 50A switch suitable for use as an isolator switch.

Junction boxes

5A 4 terminal selective entry 4 x 1.5mm



GJB5ABR

Product code	Description	Pack qty
GJB5A	White	10
GJB5ABR	Brown	10

20A 4 terminal selective entry 3 x 2.5mm



GJB20A

Product code	Description	Pack qty
GJB20A	White	10
GJB20ABR	Brown	10

20A 4 terminal non-selective entry 3 x 2.5mm



GJBN20ABR

Product code	Description	Pack qty
GJBN20A	White	10
GJBN20ABR	Brown	10

20A 6 terminal selective entry x 2.5mm



GJB620A

Product code	Description	Pack qty
GJB620A	White	10
GJB620ABR	Brown	10

30A 3 terminal selective entry x 4mm



GJB30ABR

Product code	Description	Pack qty
GJB30A	White	10
GJB30ABR	Brown	10

Compact 20A 4 terminal non-selective entry 59mm ø



GJBN20AS

Product code	Description	Pack qty
GJBN20AS	White	10
GJBN20ASBR	Brown	10

- **Standard of compliance:**
BS EN 60670-22
- **Technical notes:**
Dimensions: 5A & 20A - ø74mm, 30mm - ø85mm.
- **Terminal capacity:**
5A 4 x 1.5mm²
20A 2 x 2.5mm²
30A 4 x 4mm².

Junction boxes

Circular 50.8mm fixing centre



CRB2W

Product code	Description	Pack qty
CRB2W	Circular 50.8mm fixing centre	10

Square 34mm deep



GDL1

Product code	Description	Pack qty
GDL1	1 gang	10
GDL1	2 gang	10

- **Standard of compliance:** BS 5733
- **Technical notes:** Circular boxes suitable for pendant drops & smoke alarms.
- **Circular diameter:** 67mm
- **Square:** min. & max. thickness 2-17mm.

Flush galvanised steel boxes

16mm deep



SB161

Product code	Description	Pack qty
SB161	1 gang	20

25mm deep



SB252

Product code	Description	Pack qty
SB251	1 gang	10
SB252	2 gang	10

35mm deep



SB351

Product code	Description	Pack qty
SB351	1 gang	10
SB352	2 gang	5

47mm deep



SB472

Product code	Description	Pack qty
SB471	1 gang	10
SB472	2 gang	4

- **Standard of compliance:** BS 4662
- **Technical notes:** Supplied with earth terminal and screw.
Supplied with fixed and adjustable lugs.
Fitted with selection of 20mm knockouts in sides and back.

Plugs & adaptors

Round pin plug



TOP5AR

Product code	Description	Pack qty
TOP2AR	2A	20
TOP5AR	5A	20
TOP15AR	15A	20

- **Standard of compliance:**
BS 1363 (13A plugs)
BS 546 (round pin plugs)

Fused plug top

Product code	Description	Pack qty
TOP133A	3A white	20
TOP13A	13A white	20
400102	13A white	20
400104	13A heavy duty orange	1

Adaptors



ADAPT3WF

Product code	Description	Pack qty
ADAPT2W	2 way unfused	10
ADAPT3WF	3 way fused	10

BS 1362 fuses



400114

Product code	Description	Pack qty
400112	3A	4
400113	5A	4
400114	13A	4

Plain IP56 moulded enclosures

6 entries



GE115P

Product code	Description	Pack qty
GE115P	100 x 100 x 50mm	1
GE125P	120 x 80 x 50mm	1

- **Technical notes:**
GE321P & GE381P
- Hinged lids.

GE84S & GE884S
- IP44 rating.

10 entries



GE197P

Product code	Description	Pack qty
GE157P	150 x 110 x 70mm	1
GE197P	190 x 140 x 70mm	1

12 entries



GE249P

Product code	Description	Pack qty
GE249P	240 x 190 x 90mm	1
GE321P	300 x 220 x 120mm	1
GE381P	380 x 300 x 120mm	1

Stepped IP56 moulded enclosures

4 entries



GE84S

Product code	Description	Pack qty
GE84S	80 x 40mm	1

- **Technical notes:**
GE321P & GE381P
- Hinged lids.

GE84S & GE884S
- IP44 rating.

6 entries



GE115S

Product code	Description	Pack qty
GE884S	80 x 80 x 40mm	1
GE115S	100 x 100 x 50mm	1



Weatherproof

Weatherproof solutions

Our weatherproof range offers tough, durable options for outdoor applications or more arduous environments. Socket outlets are IP66 or IP55 rated for even greater weather resistance.



IP66

The IP66 range of weatherproof accessories offers the greatest amount of weatherproof protection on the market, with built-in features to safeguard users in the harshest of environments.

- Solid Protection: Completely protected against dust, the maximum rating for protection against solids.
- Liquid Protection: Protected against jets of water of similar force to heavy seas.



IP55

For general weatherproof protection, the IP55 range of switches and sockets can be comfortably operated through a protective membrane, thus maintaining its full IP rating.

- Solid Protection: Protected against quantities of dust that could interfere with satisfactory operation.
- Liquid Protection: Protected against jets of water from all directions



KAVACHA

With its unique polycarbonate construction, Kavacha IP56 Sockets provide the ideal domestic weatherproof and waterproof solution for full-time protection in areas around the home that are susceptible to water, rain and moisture.

Offering maximum protection, the sturdy range of Kavacha IP66 switches are ideal for outdoor areas that are susceptible to heavy blows, long time exposure to the elements and risk being splashed by chemicals.

IP55 Range

For general weatherproof protection against dust and liquids, the IP55 range of switches and sockets offers an effective solution for both indoor and outdoor environments when the maximum IP66 rating is not required.

The weatherproof membrane is Phthalate free, UV stabilised and mould and algae resistant, to ensure long outdoor life without splitting or discolouring.

Switches can be operated through membrane, thereby maintaining full IP rating

IP55 switches supplied complete in 1, 2 or 3 gang configurations using 25mm modules



All modules are independently type tested, with the enclosures giving a degree of ingress protection of IP55 – protection against quantities of dust that could interfere with satisfactory operation or powerful jets of water from all directions

Enclosures are fitted with 20mm knockouts to accept all standard UK conduit fittings and include a unique drill start feature for use with 25mm conduit fittings. The installer simply uses a standard 25mm hole saw in this drill start to ensure the correct spacing between conduit and wall.

Offered in two distinctive finish and design configurations

IP66 Range

Offering the maximum levels of endurance and protection, the IP66 weatherproof range of sockets will perform in the most arduous weather conditions.

The smooth, curved design also delivers on aesthetic appeal whilst providing a high performance application.

IP66 for maximum weatherproof protection against any particles of dust and jets of water of similar force to heavy seas whilst in use.

Manufactured from tough impact resistant thermoplastic which provides strength and durability

Standard knockouts for 20mm conduit entry with additional cut-out facility to convert to 25mm conduit entry

Protective jell seal ensures maximum safety whilst in use

IP66 sockets accept standard 13A plugs including moulded on plugs



Smooth, curved aesthetic design

Specification Highlights



Passive and Active RCD protected 2-gang socket outlet ensure essential personal protection.

Passive Latching: Designed for food freezers or garden water feature pumps, ensuring that contacts will stay closed during loss of power so that RCD does not need re-setting when the circuit is restored

Active / non-latching: Designed for lawnmowers or power tools, the RCD will trip on loss of power and requires manual resetting when the circuit is to be re-energised.



Choose from a flexible selection of IP66 enclosures and modules to meet your project requirements

Socket outlets

13A 1 gang unswitched



GWP3050

Product code	Description	Pack qty
GWPIU3050	13A 1 gang unswitched - IP66	1
GWP3050	13A 1 gang unswitched - IP55	1
E551US	13A 1 gang unswitched - IP55	1

13A 2 gang unswitched



GWPIU3060

Product code	Description	Pack qty
GWPIU3060	13A 2 gang unswitched - IP66	1
GWP3060	13A 2 gang unswitched - IP55	1

13A 1 gang switched



GWP3010

Product code	Description	Pack qty
GWP3010	13A 1 gang switched - IP55	1

13A 2 gang switched



GWPIU3020

GWP3020

Product code	Description	Pack qty
GWPIU3020	13A 2 gang switched - IP66	1
GWP3020	13A 2 gang switched - IP55	1

2 gang DP 30mA RCD protected



GWPIU3020R

Product code	Description	Pack qty
GWPIU3020R	Active control - IP66	1
GWPIU3020RP	Passive control - IP66	1

- **Standard of compliance:**
BS 1363 (13A)
BS 7288 (RCDs)
- **Mounting box:**
40mm deep (back box supplied)
- **Technical notes:**
Active control consists of an electronic latch, which will require resetting in the event of a loss of supply. Particularly useful for domestic use.

Passive control - device will only trip in the event of a fault. Suitable for freezers and commercial applications.

IP rating maintained for IP66 devices whilst in use. IP55 sockets are rated at IP4X whilst in use.

Plate switches

10AX 1 gang 2 way



GWP1612

Product code	Description	Pack qty
GWP1612	10AX 1 gang 2 way - IP55	1

- **Standard of compliance:** BS EN 60669-1
- **Mounting box:** 40mm deep (back box supplied)

10AX 1 gang intermediate



GWP1614

Product code	Description	Pack qty
GWP1614	10AX 1 gang intermediate - IP55	1

10AX 1 gang retractive



E55PB

Product code	Description	Pack qty
E55PB	10AX 1 gang retractive - IP55	1

10AX 2 gang 2 way



GWP1622

Product code	Description	Pack qty
GWP1622	10AX 2 gang 2 way - IP55	1

10AX 3 gang 2 way



GWP1632

Product code	Description	Pack qty
GWP1632	10AX 3 gang 2 way - IP55	1

Control switches

20AX DP 1 gang switch



GWP2010

Product code	Description	Pack qty
GWP2010	20AX DP 1 gang switch - IP55	1

- **Standard of compliance:** BS EN 60669-1
- **Mounting box:** 40mm deep (back box supplied)

20AX DP 1 gang switch with neon



GWP2011

Product code	Description	Pack qty
GWP2011	20AX DP 1 gang switch with neon - IP55	1

Enclosure & modules

Enclosure



GWP9000

Product code	Description	Pack qty
GWP9000	Enclosure	1

- **Standard of compliance:**
BS 5733
BS EN 60670
- **Mounting box:**
40mm deep (back box supplied)

Seal kit - 2 x silicone seals & 2 x mounting brackets



GWPIUKIT

Product code	Description	Pack qty
GWPIUKIT	Seal kit - 2 x silicone seals & 2 x mounting brackets	1

White 20AX switch modules



Product code	Description	Pack qty
GRL2020PW	2 way & off switch module	1
GRL202KPW	2 way key	1
GRL20DPNPW	Double-pole with neon	1
GRLDPKPW	Double-pole key	1

White fuse carrier, indicator & flex modules



Product code	Description	Pack qty
GRL13FCUPW	13A single-pole fuse carrier	1
GRLINDRPW	240V red indicator	1
GRLCOPW	10mm ø cord outlet	1

Connection box & grommets

Connection box



E55CB

Product code	Description	Pack qty
E55CB	Connection box	1

- **Standard of compliance:**
BS EN 60669-1
- **Mounting box:**
40mm deep (back box supplied)

Grommets



E55GP

Product code	Description	Pack qty
E55GP	Grommets	1





Kavacha

Full time protection around the home

This sturdy range of switches and sockets are for outdoor areas that are susceptible to heavy blows, long time exposure to sunlight and where there is a risk of being splashed by chemicals.

Balconies, swimming pools, exterior walls and gardens will all be much safer from exposed electricity with Kavacha. Kavacha protects you and your family outdoors in five important ways. It guards against water sprayed from a hose. It guards against rain or water, is dust proof, impact resistant, UV resistant and also chemical resistant.

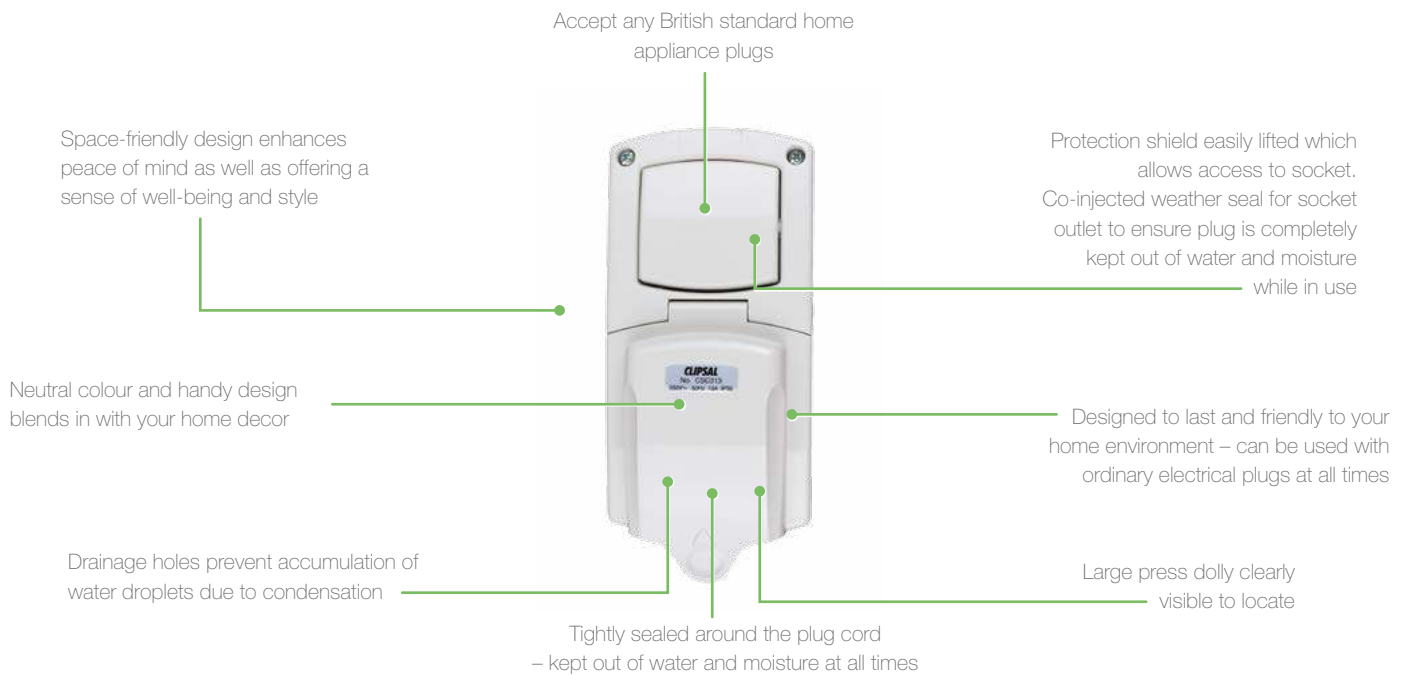

Socket outlets

IP56 13A 1 gang unswitched



CSO313

Product code	Description	Pack qty
CSO313	IP56 13A 1 gang unswitched	1

IP56 13A 2 gang unswitched



CSO3132

Product code	Description	Pack qty
CSO3132	IP56 13A 2 gang unswitched	1

IP56 13A 1 gang switched



CSC313

Product code	Description	Pack qty
CSC313	IP56 13A 1 gang switched	1

- **Standard of compliance:**

BS 1363
BS 1363-2
IEC 60529
IEC 60669-1

- **Technical notes:**

Active control consists of an electronic latch, which will require resetting in the event of a loss of supply. Particularly useful for domestic use.

Passive control - device will only trip in the event of a fault. Suitable for freezers and commercial applications.

IP rating maintained for IP66 devices whilst in use. IP55 sockets are rated at IP4X whilst in use.

Plate switches

IP66 16A 250V 1 gang 2 way



CSW120

Product code	Description	Pack qty
CSW120	IP66 16A 250V 1 gang 2 way	1

- **Standard of compliance:**

BS EN 60669-1

- **Technical notes:**

Single-pole switches include a looping terminal.

IP66 20A 250V 2 gang 2 way



CSW1202

Product code	Description	Pack qty
CSW1202	IP66 20A 250V 2 gang 2 way	1

IP66 20A 500V 1 gang double-pole isolator



CSW220

Product code	Description	Pack qty
CSW220	IP66 20A 500V 1 gang double-pole	1

Triple pole control switches

20A 440V



WHB320RG

Product code	Description	Pack qty
WHB320RG	20A 440V	1

- **Technical notes:**
32mm conduit entry each end.

40A 440V



WHB340RG

Product code	Description	Pack qty
WHB340RG	40A 440V	1

55A 440V



WHB355RG

Product code	Description	Pack qty
WHB355RG	55A 440V	1

63A 440V



WHC363RG

Product code	Description	Pack qty
WHC363RG	63A 440V	1



56 Series

56 Series industrial switchgear

Designed to satisfy customer needs, precisely engineered and carefully manufactured, the 56 Series is as versatile as your customers' requirements. Industrial switchgear, being one of the most important components of industry, has to be tough, safe, and able to take hard knocks and give reliable performance under adverse conditions.

The 56 Series satisfies these challenges with the use of durable engineering plastics. The 56 Series has been tested for protection against ingress of water and dust to international protection ratings IP56, and in many instances exceeds this level of protection.

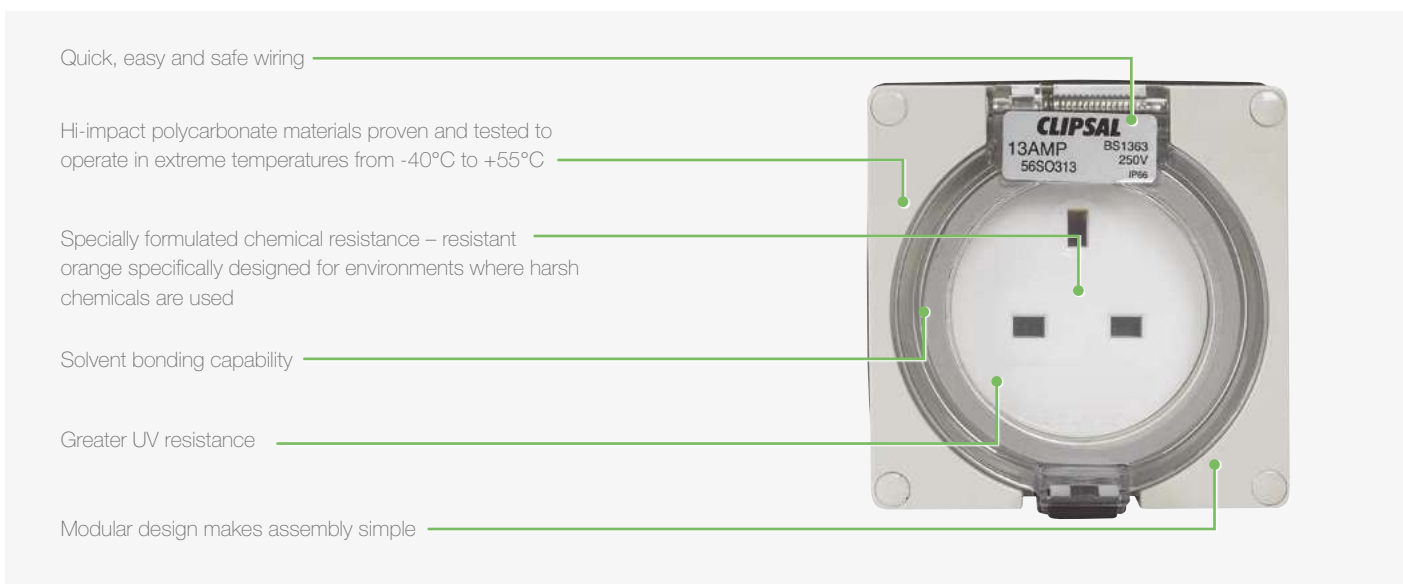

Designed to mix and match

What suits one industry might not be the perfect match for another. That's why the 56 Series was specifically designed to mix and match. There is an extensive choice of modules available, including switches, sockets and residual current devices.

56 Series mounting enclosures range from 1 to 9 gang. This allows assemblies to be customised - from a simple switch station to a large electrical control panel.

Accessories can be ordered without the back box by choosing the product code with LE (less enclosure) towards the end.





IP66 - Socket outlets

13A 250V 3 pin



56SO313LEGY

Product code	Description	Pack qty
56SO313GY	Grey (with enclosure)	1
56SO313LEGY	Grey (without enclosure)	1
56SO313RO	Resistant orange (with enclosure)	1

• **Standard of compliance:**
IEC 60529
BS 1363

16A 4h 110V

Product code	Description	Pack qty
56SO316110LEGY	Grey (without enclosure)	1

16A 6h 220/250V 3 pin

Product code	Description	Pack qty
56SO3166LEGY	Grey (without enclosure)	1

16A 6h 380/415V 5 pin



56SO5166LEGY

Product code	Description	Pack qty
56SO5166LEGY	Grey (without enclosure)	1

20A 220/250V 5 pin



56SO520LEGY

Product code	Description	Pack qty
56SO520LEGY	Grey (without enclosure)	1

32A 240V



56SO332GY

Product code	Description	Pack qty
56SO332GY	Grey (with enclosure)	1

32A 6h 220/250V 3 pin

Product code	Description	Pack qty
56SO3326LEGY	Grey (without enclosure)	1

32A 6h 380/415V 4 pin

Product code	Description	Pack qty
56SO4326LEGY	Grey (without enclosure)	1

32A 6h 380/415V 5 pin

Product code	Description	Pack qty
56SO5326LEGY	Grey (without enclosure)	1

IP66 - Fuse units

15A 250V switched



56FCULEGY

Product code	Description	Pack qty
56FCUGY	Grey (with enclosure)	1
56FCULEGY	Grey (without enclosure)	1

- **Standard of compliance:**
IEC 60529

IP66 - Rotary switches

10AX 240/250V 1 way



56SW110GY

Product code	Description	Pack qty
56SW110GY	Grey (with enclosure)	1
56SW110LEGY	Grey (without enclosure)	1
56SW110LERO	Resistant orange (without enclosure)	1

- **Standard of compliance:**
IEC 60669-1
IEC 60529

20A 250V

Product code	Description	Pack qty
56SW120LEGY	Grey (without enclosure)	1
56SW120LERO	Resistant orange (without enclosure)	1

32A 250V



56SW132LEGY

Product code	Description	Pack qty
56SW132LEGY	Grey (without enclosure)	1

IP66 - Double-pole switch disconnectors

20A 500V



56SW220LERO

Product code	Description	Pack qty
56SW220LEGY	Grey (without enclosure)	1
56SW220LERO	Resistant orange (without enclosure)	1

• **Standard of compliance:**
BS EN 60947-3

32A 500V



56SW232LERO

Product code	Description	Pack qty
56SW232LEGY	Grey (without enclosure)	1
56SW232LERO	Resistant orange (without enclosure)	1

IP66 - Triple-pole switch disconnectors

10A 500V



56SW310LEGY

Product code	Description	Pack qty
56SW310LEGY	Grey (without enclosure)	1

• **Standard of compliance:**
BS EN 60947-3

20A 500V



56SW320LEGY

Product code	Description	Pack qty
56SW320LEGY	Grey (without enclosure)	1
56SW320LERO	Resistant orange (without enclosure)	1

32A 500V



56SW332LERO

Product code	Description	Pack qty
56SW332LEGY	Grey (without enclosure)	1
56SW332LERO	Resistant orange (without enclosure)	1

50A 500V



56SW350LEGY

Product code	Description	Pack qty
56SW350LEGY	Grey (without enclosure)	1

63A 500V



56SW363LEGY

Product code	Description	Pack qty
56SW363LEGY	Grey (without enclosure)	1
56SW363LERO	Resistant orange (without enclosure)	1

IP66 - Control switches

10AX 250V single sliding dolly



56SSW10LEGY

Product code	Description	Pack qty
56SSW10LEGY	Grey (without enclosure)	1

• **Standard of compliance:**
BS EN 60947-3

10A 250V two way

Product code	Description	Pack qty
56SSW210LEGY	Grey (without enclosure)	1

15AX 250V single sliding dolly



56SSW15LEGY

Product code	Description	Pack qty
56SSW15LEGY	Grey (without enclosure)	1
56SSW15LERO	Resistant orange (without enclosure)	1

15A 250V two way

Product code	Description	Pack qty
56SSW215LEGY	Grey (without enclosure)	1

20A 500V DP changeover & reversing



56SW220COLEGY

Product code	Description	Pack qty
56SW220COLEGY	Grey (without enclosure)	1

20A 440V 4 pole

Product code	Description	Pack qty
56SW420LERO	Resistant orange (without enclosure)	1

Emergency stop push



56PBS1LEGY

Product code	Description	Pack qty
56PBS1LEGY	Grey (without enclosure)	1

IP66 - Plugs

10A 250V 3 pin



56P310GY

Product code	Description	Pack qty
56P310GY	Grey	1

• **Standard of compliance:**
IEC 60529
BS 1363
BS 546

13A 250V 3 pin



56P313GY

Product code	Description	Pack qty
56P313GY	Grey	1
56P313RO	Resistant orange	1
56P313EO	Electric orange	1

15A 250V 3 pin



56P315GY

Product code	Description	Pack qty
56P315GY	Grey	1

Moulded covers

1 gang lid for 2 x E-Series mechanisms

Product code	Description	Pack qty
5632LEGY	Grey	1
5632LERO	Resistant Orange	1

• **Standard of compliance:**
IEC 60529
BS 5733

2 gang lid for 4 module device



56CB4GY

Product code	Description	Pack qty
56CB4GY	Grey	1

2 gang lid for 4 module device with neons

Product code	Description	Pack qty
56CB4NGY	Grey	1
56CB4NRO	Resistant orange	1

1 gang blank lid



56L1GY

Product code	Description	Pack qty
56L1GY	Grey	1

2 gang blank lid



56L2GY

Product code	Description	Pack qty
56L2GY	Grey	1

Surface mounted enclosure

1 gang 101 x 101 x 63mm



56E1RO

Product code	Description	Pack qty
56E1GY	Grey	1
56E1RO	Resistant orange	1

- **Standard of compliance:**
BS EN 60947-3

1 gang shallow 101 x 101 x 38mm



56ES1GY

Product code	Description	Pack qty
56ES1GY	Grey	1

2 gang 198 x 101 x 63mm



56E2RO

Product code	Description	Pack qty
56E2GY	Grey	1
56E2RO	Resistant orange	1

2 gang shallow 198 x 101 x 38mm



56ES2GY

Product code	Description	Pack qty
56ES2RO	Grey	1
56ES2GY	Resistant orange	1

2 gang deep 198 x 101 x 100mm



56ED2GY

Product code	Description	Pack qty
56ED2GY	Grey	1

3 gang 294 x 101 x 63mm

Product code	Description	Pack qty
56E3GY	Grey	1
56E3RO	Resistant orange	1

Surface mounted enclosure continued

4 gang 198 x 198 x 63mm



56E4GY

Product code	Description	Pack qty
56E4GY	Grey	1
56E4RO	Resistant orange	1

• **Standard of compliance:**
BS EN 60947-3

4 gang vertical 391 x 101 x 63mm



56E4VHGY

Product code	Description	Pack qty
56E4VHGY	Grey	1

6 gang 294 x 198 x 63mm

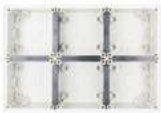

Product code	Description	Pack qty
56E6GY	Grey	1
56E6RO	Resistant orange	1

8 gang 391 x 198 x 63mm

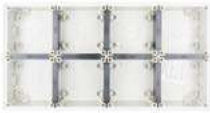

56E8GY

Product code	Description	Pack qty
56E8GY	Grey	1
56E8RO	Resistant orange	1

9 gang 294 x 294 x 63mm



56E9GY

Product code	Description	Pack qty
56E9GY	Grey	1

Flush mounted surrounds

1 gang



56FA1GY

Product code	Description	Pack qty
56FA1GY	Grey	1

2 gang



56FA2GY

Product code	Description	Pack qty
56FA2GY	Grey	1

3 gang



56FA3GY

Product code	Description	Pack qty
56FA3GY	Grey	1

4 gang



56FA4GY

Product code	Description	Pack qty
56FA4GY	Grey	1

Combination devices

13A 250V 2 pin socket & switch



56C313GY

Product code	Description	Pack qty
56C313GY	Grey (with enclosure)	1

- **Standard of compliance:**
IEC 60529
BS 1363

13A 250V 1 gang socket with RCD



56C3134ELGY

Product code	Description	Pack qty
56C3134ELGY	Grey (with enclosure)	1

13A 250V 2 gang socket with RCD

Product code	Description	Pack qty
56C31324ELGY	Grey (with enclosure)	1

Junction box

1 gang



56JB1GY

Product code	Description	Pack qty
56JB1GY	Grey (with enclosure)	1

- **Standard of compliance:**
IEC 60529
BS 5733



Desk units



Desk units

IDU - In-Desk Units

In Desk Units bring flexibility to the desktop, such as conference and training rooms. The range facilitates unrestricted individual access to power, media and data right on the table or desktop. Minimal depth also means no restriction on leg movement under the desk or table, even where the units are fitted near the edge.



FDU - Flush Desk Units

FDU is perfect for commercial installations such as meeting rooms, offices or desk sharing environments.

The ideal solution where flexibility is needed, these can be fixed with mounting brackets or can be free standing.



PTU - Pop Up Tower Units

Pop Up Towers fit perfectly in any working environment. The range is ideal for integrating power and data connections in tiny spaces.

Simply press down with your thumb to raise and lower the Pop Up Tower. Installation is incredibly simple. PTU is placed in a cut-out 79 mm in diameter and secured to the desk or table top from below using a lock ring.



ODU - On-Desk Units

On Desk Units can be mounted on the edge of a desk or table quickly and easily using a mounting bracket.

A size 4 Allen key is required in order to tighten the inside screw on the bracket. Mounting does not damage the table/desk top.



UDU - Under Desk Units

The Under Desk Units are available with a plastic profile. It is possible to connect multiple power strips together to form a modular system.

The range is designed primarily as a simple electricity supply unit for office workstations and permanently installed devices such as PCs, monitors, printers, etc. can be connected to the UDU.



Select Custom Modules

Mita SELECT custom modules are the central components of video, audio and network connections.

Their construction offers you simple and flexible installation in facility systems, rack systems and electrical installations. The versatility of SELECT custom modules make Mita facility systems even more flexible.



IDU - In-Desk Units

Frames



Product Code	Description	Finish	Dimension
INS91001	Frame For 3 Way In Desk Unit	Silver-Grey	248 x 151 x 58mm
INS91002	Frame For 6 Way In Desk Unit	Silver-Grey	386.5 x 151 x 58mm

- Integrated into the top of a desk or table
- Provides access to power, media and data
- Minimal depth
- Brush inserts to prevent the cables becoming lodged
- High quality and sturdy frame design
- Configuration can be freely selected thanks to the modular solution.

Power Strips



Product Code	Description	Finish	Dimension
INS91210	2 Power & 1 Select Module	Black/Silver	217 x 52 44mm
INS91201	2 Power & 1 Twin USB Charger	Black/Silver	TBC
INS91330	3 Power & 3 Select Modules	Black/Silver	355 x 52 x 44mm
INS91231	2 Power, 1 Twin USB & 3 Select Modules	Black/Silver	355 x 52 x 44mm

FDU - Flush Desk Units

Frames



Product Code	Description	Finish	Dimension
INS92001	Frame For 3 Way Flush Desk Unit	Silver-Grey	241 x 73 x 36mm
INS92002	Frame Cover For 3 Way Flush Desk Unit	Aluminium	255 x 87 x 43mm

- Practical and quick installation
- Custom modules
- Power and data sockets at the rear of the power strip
- Configuration can be freely selected thanks to the modular solution.

Power Strips



Product Code	Description	Finish	Dimension
INS92210	2 Power & 1 Select Module	Black	220 x 52 x 44mm
INS92300	3 Power	Black	220 x 52 x 44mm

SELECT Custom modules available on [p183](#).

PTU - Pop Up Tower Units

Pop Up Tower Units



Product Code	Description	Finish	Dimension
INS93102	1 Power & 1 Twin Usb Charger	Black/Silver	115 dia (locking ring) x 135mm Cutting diameter 80mm
INS93120	1 Power & 2 RJ45	Black/Silver	115 dia (locking ring) x 135mm Cutting diameter 80mm
INS93111	1 Power, 1 USB charger & 1 RJ45	Black/Silver	115 dia (locking ring) x 135mm Cutting diameter 80mm

- Press down to raise the pop up tower
- Fast and easy to install
- Available in 3 configurations
- Suitable for desk or table tops

ODU - On-Desk Units

Power Strips



Product Code	Description	Finish	Dimension
INS94220	2 Power & 2 Select Module	Black/Silver	346.3 x 73 x 88mm
INS94211	2 Power 45°, 1 Twin USB & 1 Select Module	Black/Silver	300.7 x 73 x 88mm
INS94312	3 Power, 1 Twin USB & 2 RJ45	Black/Silver	386.3 x 73 x 88mm
INS94302	3 Power & 2 RJ45	Black/Silver	344.2 x 73 x 88mm

- Flexible for any location
- Suitable for meeting rooms, home offices or desk sharing environments
- Can be mounted to a desk or table quickly and easily with the mounting brackets
- Configuration can be freely selected thanks to the modular solution.

Accessories



Product Code	Description	Finish	Dimension
INS94001	Spax Fixing Screws For End Caps	Incl. Brass threaded sleeve	4mm Dia x 90mm (46mm thread length)
INS94002	Mounting Brackets	Anodised Aluminium	70 x 50 x 8.2mm

SELECT Custom modules available on [p183](#).

UDU - Under Desk Units

Power Strips



Product Code	Description	Finish	Dimension
INS95102	2 Power 45° & 2 Switches	Black/Silver	245 x 52 x 43mm
INS95104	4 Power 45° & 1 Switch	Black/Silver	365 x 52 x 43mm

- Flexible and versatile power supply to workstations
- Easy installation and can be removed at any time
- Multiple fixing options, can be fitted under tables or desks, in cable ducts or in partitions

Safety Module



Product Code	Description	Finish	Dimension
INS95000	Overvoltage Protection Unit	With mains & Frequency filters	220 x 52 x 43mm

Accessory



Product Code	Description	Finish	Dimension
INS95001	Stainless Steel Flat Mounting Plates		55 x 51 x 1mm

Select Custom Modules

Select Custom Modules









Product Code	Description	Finish
INS90001	1 VGA & Miniature Jack	Black
INS90002	1 HDMI Keystone	Black
INS90003	2 Keystone Modules	Black
INS90004	1 Keystone Module	Black

- Flexibly interchangeable modules
- For data, video and audio connections
- Easy to connect via socket/socket or screw terminal connections
- Ability to upgrade your equipment with the latest custom modules.

Select Custom Modules - Continued

Select Custom Modules

	Product Code	Description	Finish
	INS90005	Cat6 Coupling Socket/Socket	Front: RJ45. Rear: Tj45 - Unshielded
	INS90006	CAT6 Coupling Socket	Front: RJ45. Rear: Tj45 - Shielded
	INS90007	Keystone Socket Cover	Black
	INS90008	1 Data Cabling Bushing	Black
	INS90009	1 VGA Cabling Bushing	Black
	INS90010	Blank Cover	Black
	INS90011	1 USB 3.0A / A Keystone	Black

GST Power Leads

GST power leads



Product Code	Description	Finish
INS90502	1.5mm ² , UK 13A Plug, GST18i3 Socket	2M Length
INS90504	1.5mm ² , UK 13A Plug, GST18i3 Socket	4M Length

- Supply and extension cables are pre-assembled with integrated earth connection
- Available in different lengths enabling the extension of the power strips without the need for tools

GST connector leads



Product Code	Description	Finish
INS90510	1.5mm ² , GST18i3 Plug, GST18i3 Socket	0.3M Length
INS90511	1.5mm ² , GST18i3 Plug, GST18i3 Socket	1M Length
INS90513	1.5mm ² , GST18i3 Plug, GST18i3 Socket	3M Length

Connectors



Product Code	Description	Finish
INS90520	GST/GST Coupler Connector	40 x 28 x 11mm
INS90521	1xInput, 2xOutput Multiplier GST18	44 x 28 x 43mm
INS90522	1xInput, 2xOutput Multiplier GST18	65 x 48 x 15mm
INS90523	Appliance Plug With Screw Terminal	70 x 28 x 13mm

A photograph of a woman and a man walking in a modern, brightly lit interior space. The woman is in the foreground, wearing a grey patterned sweater and carrying a red drawstring backpack. The man is walking slightly behind her to the right, wearing a red striped shirt and khaki pants. The background shows architectural elements like white walls and a dark ceiling. A green semi-transparent banner is overlaid on the left side of the image, containing the text.

Occupancy & Presence Detection

Occupancy & Presence detection



ARGUS Presence Detector System:

Enjoy the fully networked presence detector solution offered by the Argus range, as well as stand-alone options for individual requirements



Stand-alone Occupancy Sensors

The Schneider Electric occupancy sensor range combines a selection of outdoor passive infra-red devices, and indoor ceiling or wall mountable devices to meet your energy saving needs.



Argus

Argus presence detector system

The Argus presence detector range offers efficient stand-alone and system solutions for the different requirements of your customers: daylight harvesting for consistent brightness by the use of 1-10V and DALI as well as the control of heating or ventilation.

Networking presence detectors increases the detection areas, thus providing a close detection of larger rooms and areas as required.



Master/Slave

Up to 10 masters and 10 slaves can be interconnected via a single core 230V cable. This means long corridors and large stairwells are easy to monitor.

Control via a retractive switch

The overshoot time that has been set can be activated via a retractive switch.

Staircase timer

Depending on requirements, the staircase timer can be infinitely adjusted between 10 seconds and 30 minutes.

Two channels for integrating heating or ventilation

The first channel automatically controls the lighting depending on brightness and presence; the second channel controls connected loads such as heating or ventilation depending on presence only.

Argus presence detectors

Master with IR, relay



MTN55101119

Product code	Description	Pack qty
MTN55101119	1 gang	1
MTN55101219	2 gang	1

Functions:

- Switching of one output.
- External triggering via one PL-input (Slaves).
- Switching.
- Brightness-dependent staircase lighting function.
- **MTN55101219** - with channel 1, staircase lighting function independent of brightness with channel 2.

• **Technical notes:**
For ohmic, inductive and capacitive loads such as incandescent lamps, energy-saving lamps, LV halogen lighting with conventional transformer, electronic transformers, fluorescent lamps.

Master with IR, 1-10V



MTN55101419

Product code	Description	Pack qty
MTN55101419	Master with IR, 1-10V	1

Functions:

- Switching & dimming of one output.
- External triggering via one PL-input (Slaves).
- Memory function.
- Brightness-dependent staircase lighting function.

• **Technical notes:**
For fluorescent lamps with electronic ballast or electronic transformer with 1-10V interface. The switchable light control ensures that the room illumination remains almost constant. The sensor module continuously measures the brightness in the room and adjusts the illumination to an adjustable setpoint.

Master with IR, DALI



MTN55101519

Product code	Description	Pack qty
MTN55101519	Master with IR, DALI	1

Functions:

- Switching & dimming of DALI EBs.
- External triggering via one PL-input (Slaves).
- Overload and short-circuit proof.
- Memory function.
- Up to 6 DALI control inserts can be connected to one DALI line. However, the maximum number of 64 DALI Ebs and a cable length of 300m must not be exceeded.
- Brightness-dependent staircase lighting function.

• **Technical notes:**
For triggering up to 15 DALI Ebs. The switchable light control ensures that the room illumination remains almost constant. The sensor module continuously measures the brightness in the room and adjusts the illumination to an adjustable setpoint.

Slave



MTN55701019

Product code	Description	Pack qty
MTN55701019	Slave	1

Functions:

- Global control via four PL-outputs.
- Staircase lighting function independent of brightness.

• **Technical notes:**
For triggering all Argus presence masters; the device has four PL-outputs. The control function via PL requires a separate core in the installation to the receiving master devices for each PL line.

Surface mounted back box



MTN550619

Product code	Description	Pack qty
MTN550619	Surface mounted back box	1

Flush mounted back box



ALB71322

Product code	Description	Pack qty
ALB71322	Flush mounted back box	1

IR remote control, distance 2010



MTN570222

Product code	Description	Pack qty
MTN570222	IR remote control, distance 2010	1

Battery:
2 microcells (IEC LR 03, AAA).

Range:
Up to 20m.

Contents:
Without battery.

- **Technical notes:**
10 channel IR remote control.

PlusLink expander



CCTDT5130

Product code	Description	Pack qty
CCTDT5130	PlusLink expander	1

Nominal voltage:
AC 220/230V.

Neutral connector:
Required (3 conductor system).

Wire range:
Max. 4mm².

Device width:
1HP=18mm.

- **Technical notes:**
The PlusLink extension needs to be integrated into one or more PL-lines if there are protected by at least two circuit breakers. If a circuit breaker is triggered in the event of maintenance work or a fault, then the PlusLink expansion will disconnect the PlusLink line automatically as well. This is necessary because the PlusLink line would otherwise continue to be live via the other circuit breakers. With screw terminals. Suitable for installation on DIN rails TH35 according to EN 60715.

A man with dark, curly hair is standing in profile, looking towards the right. He is wearing a light pink, long-sleeved button-down shirt tucked into dark grey or black trousers, secured with a black belt. He is standing in a modern office environment with large glass windows in the background. The windows reflect the interior of the building and show some greenery outside. A green horizontal bar is overlaid on the image, containing the text 'Stand-alone Detectors'.

Stand-alone Detectors

Stand-alone Detectors

By leveraging state of the art infra-red, and combined ultrasonic and infra-red (dual technologies), our ultra sensitive occupancy sensors offer you the ultimate in reliable, efficient and cost effective lighting control.

This provides a quick and environmentally friendly way of reducing energy consumption with easy setup. Compared to a traditional manual switch, there are significant potential energy savings that can be achieved by utilising occupancy sensors.

The Schneider Electric occupancy sensor range combines a selection of outdoor passive infra-red devices, and indoor ceiling or wall mountable devices.



Indoor sensors

360° ceiling mounted



SAEUEMSCSAWE

Product code	Description	Pack qty
SAEUEMSIR10T	Remote control for SAEUEMSCUWE	1
SAEUEMSCSAWE	Single-load PIR	1
SAEUEMSCDBWE	Dual-load PIR	1

• **Technical notes:**
 Flush or surface mounted;
 SAEUEMSCDBWE flush mount only. 7m at 2.5m height range; SAEUEMSCUWE 12m x 18m at 2.5m height range.

Infra-scan 120° wall mounted



E751 & E751R

Product code	Description	Pack qty
E751	2A PIR	1
E751R	10A PIR	1

• **Technical notes:**
 Surface mount.
 Detection area 6m x 6m at 2.4m height range.

PIR plate switch wall mounted



GUPA1411BSS

Product code	Description	Pack qty
GUPA1411BSS	PIR plate switch wall mounted with override	1
GUP1411BSS	PIR plate switch wall mounted	1

• **Technical notes:**
 Field of view: 90°.
 Range: 5m at 1.2m height. Time setting: 15sec - 30min.
 Stainless steel with black interior finish only.

Outdoor sensors

Single-load PIR



CCT56P004



CCT56P008

Product code	Description	Pack qty
CCT56P004	120°	1
CCT56P008	360°	1

- Technical notes:**
 Detection field up to 18m. Includes separate mounting base. Base includes conduit entries. Suitable for wall or ceiling mounting.

Infrascan single-load PIR



E750WPRGY

Product code	Description	Pack qty
E750WPRGY	110°	1

- Technical notes:**
 Detection field up to 18m. Includes separate mounting base. Base includes conduit entries. Suitable for wall or ceiling mounting.

Clipsal C-Bus























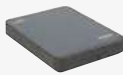



Innovative control systems for commercial or residential...

Take advantage of the benefits a fully programmable and customisable control system can provide. Introducing Clipsal, a system that can deliver a complete lighting and room control solution to help you achieve your goals, whether in residential or commercial applications.

In homes, C-Bus offers a total control solution ensuring that your property is secure, entertaining, exciting, relaxing, beautiful and you.

For commercial projects you will find a various options for intelligent building control which offer not only improved comfort, but also provide significant energy savings.

<p>C-Bus Input Units</p>	<p>Wall Switches</p> 	<p>Touch Screen Controllers</p> 	<p>Occupancy Sensors</p> 	<p>Environment Sensors</p> 	<p>General Input Units</p> 	<p>Handheld IR Remotes</p> 
<p>C-Bus Output Units</p>	<p>DIN Rail Dimmers</p> 	<p>DIN Rail Relays</p> 	<p>Blind control relay</p> 	<p>1 & 2 channel relay range</p> 	<p>Extra Low Voltage Relay</p> 	<p>Infrared Transmitters</p> 
<p>C-Bus System Units and Accessories</p>	<p>Controllers</p> 		<p>Network Support Devices</p> 	<p>Gateways</p> 	<p>Network analyser</p> 	
<p>C-Bus Software</p>	<p>Toolkit software</p> 	<p>PICED software</p> 	<p>OPC Server software</p> 	<p>Schedule Plus</p> 	<p>HomeGate software</p> 	
<p>C-Bus Multi-Room Audio</p>	<p>Matrix Switcher</p> 		<p>Amplifier power supply</p> 	<p>Distribution unit</p> 	<p>Amplifiers accessories</p> 	

The best just got better...

Introducing our new Saturn eDLT range

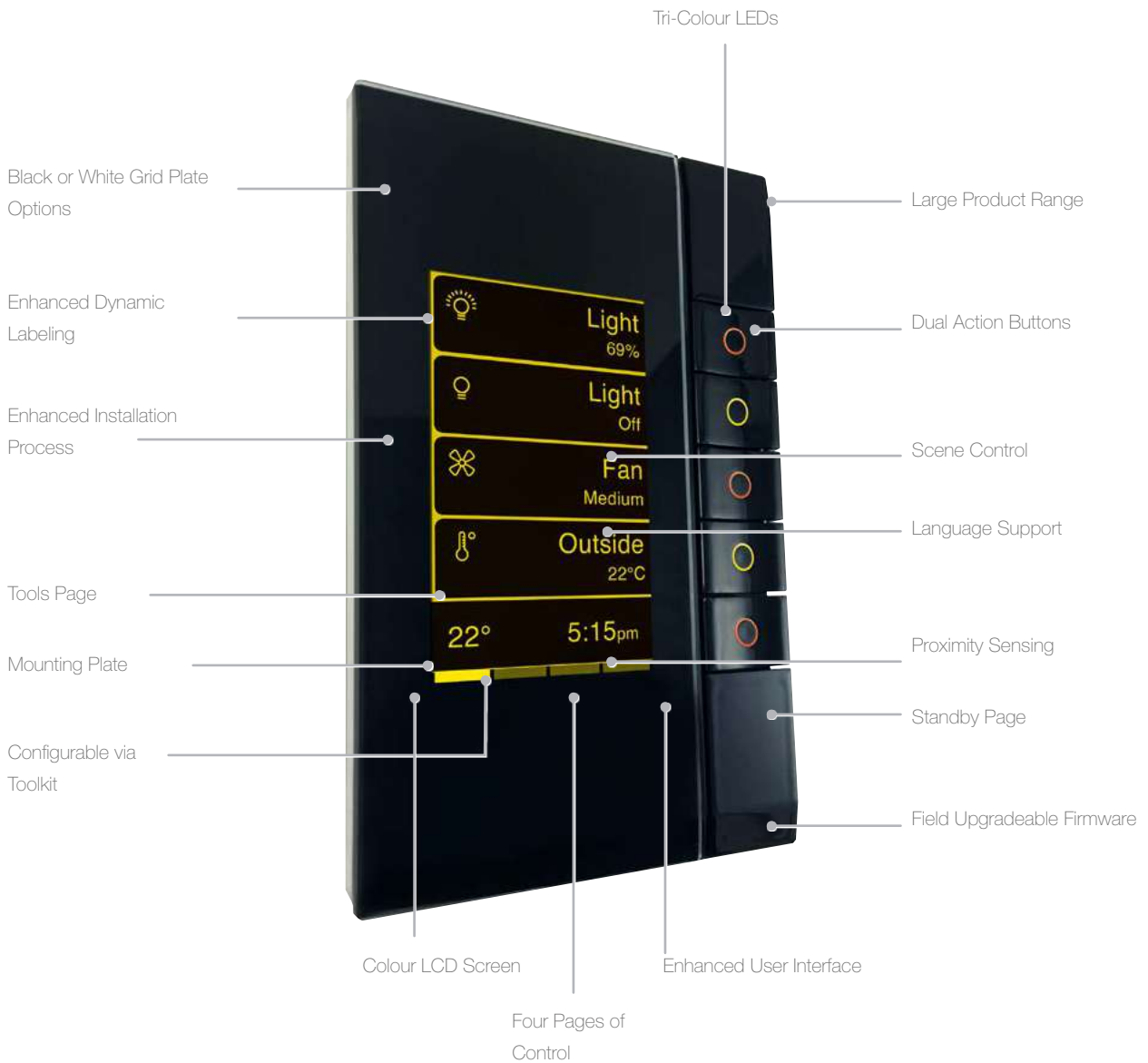

Saturn eDLT...

With the ability to customise the colour of the display and button, advanced device control, and intuitive functionality, the eDLT offers fantastic features and benefits that will enhance and complement your lifestyle.



Customisable Colour Options

Select from eight colour options to customise the screen and buttons to suit your style. The eDLT can also indicate system information for you, such as high energy use (red) or security disarmed (green).



Scene Control

The eDLT simplifies living by integrating multiple technologies around your home to work in unison at the touch of a button.

For example; a “Movie” scene for your home theatre could dim the lights, turn on the projector and lower the screen; or a “Goodnight” could scene could conveniently turn off all the lights in your home from the comfort of your bedroom.



Enhanced Control Capability

The eDLT replaces the need for multiple wall switches, and provides you with up to 16 control functions in one stylish unit.



Technical information



ARGUS presence detector system

ARGUS presence detector system

Product Code	MTN55101119	MTN55101219	
Description	Presence Master with IR, relay 1-gang	Presence Master with IR, relay 2-gang	
Nominal voltage	AC 220/230V, 50/60Hz	AC 220/230V, 50/60Hz	
Nominal current	max. 10AX, $\cos\varphi = 0.6$	Max. 10AX, $\cos\varphi = 0.6$. The total load on both channels is not allowed to exceed 14A	
Control current	-	-	
Type	-	-	
Load type	-	-	
Outputs	1 x make contacts	2 x make contacts	
Max. switching capacity per channel:			
Incandescent lamps	2200W	2200W	
HV halogen lamps	2000W	2000W	
LV halogen lamps with wound transformer	500VA	500VA	
Electronic transformers	1050W	1050W	
Capacitive load	10A, 140 μ F	10A, 140 μ F	
Energy-saving lamps	100VA	100VA	
Motor load	1000VA	1000VA	
Neutral conductor	Required (3 conductor system)	Required (3 conductor system)	
Cable capacity	max. 2x2.5mm ²	max. 2x2.5mm ²	
Angle of detection	360°	360°	
Number of levels	6	6	
Number of zones	136	136	
Number of movement sensors	4	4	
Recommended installation height	2.5m	2.5m	
Range	A radius of max. 7m (at an installation height of 2.5m)	A radius of max. 7m (at an installation height of 2.5m)	
Sensitivity	Continuously adjustable	Continuously adjustable	
Brightness threshold	Continuously adjustable between approx. 10 and 1000 lux	Continuously adjustable between approx. 10 and 1000 lux	
Overshoot time	Channel 1: continuously adjustable between approx. 10s and approx. 30min	Channel 1: continuously adjustable between approx. 10s and approx. 30min	
		Channel 2: continuously adjustable between approx. 5min and approx. 2h	
Slave	ARGUS Presence Slave MTN55701019	ARGUS Presence Slave MTN55701019	

ARGUS presence detector system

MTN55101419	MTN55101519	MTN55701019
Presence Master with IR, 1-10V	Ultimate screwless	Presence Slave
AC 220/230V, 50/60Hz	230V 50Hz	AC 220/230V, 50/60Hz
max. 10AX, $\cos\varphi = 0.6$	90°	-
max. 50mA	5m at 1.2m height	-
-	Wall (flush)	-
max. 25 controllable EBs (1-10V)	Single	-
1 x make contact, 1 x (1-10V)	X	4 x PL
2200W	-	-
2000W	-	-
500VA	-	-
1050W	-	-
10A, 140 μ F	-	-
-	-	-
-	-	-
Required (3 conductor system)	Required (3 conductor system)	Required (3 conductor system)
max. 2x2.5mm ²	max. 2x2.5mm ²	max. 2x2.5mm ²
360°	360°	360°
6	6	6
136	136	136
4	4	4
2.5m	2.5m	2.5m
A radius of max. 7m (at an installation height of 2.5m)	A radius of max. 7m (at an installation height of 2.5m)	A radius of max. 7m (at an installation height of 2.5m)
Continuously adjustable	Continuously adjustable	Continuously adjustable
Continuously adjustable between approx. 10 and 1000 lux	Continuously adjustable between approx. 10 and 1000 lux	-
Channel 1: continuously adjustable between approx. 10s and approx. 30min	Channel 1: continuously adjustable between approx. 10s and approx. 30min	Channel 1: continuously adjustable between approx. 10s and approx. 30min
ARGUS Presence Slave MTN55701019	ARGUS Presence Slave MTN55701019	-

Occupancy sensors technical overview

	Ceiling Mounted				
Product Code	SAEUEMSCUWE	SAEUEMSCSAWE	SAEUEMSCDBWE	E751	
Product Description	Single-Load 360° PIR and Ultrasonic Sensor	Single-Load 360° PIR Sensor	Dual-Load 360° PIR Sensor	Infrascan single-load 120° PIR sensor	
Operating voltage	230V 50/60Hz	230V 50/60Hz	230V 50/60Hz	200-265V 50Hz	
Field of view	360°	360°	360°	120°	
Range	12m×18m at 2.5m height	7m at 2.5m height	7m at 2.5m height	6m x 6m, 8.5m from sensor head. Head rotatable through 120°	
Mounting	Ceiling (surface / flush)	Ceiling (surface / flush)	Ceiling (flush)	Ceiling (surface)	
Single or Dual Load:	Single	Single	Dual	Single	
IR Remote Control*	SAEUEMSIR10T	X	X	X	
Incandescent	2000W	2000W	2000W	2A	
Halogen lamps 230V	1000W	1000W	1000W	2A	
Halogen w. Electronic transformer	1000VA	1000VA	1000VA	2A (iron core transformer only)	
Fluorescent tubes	900VA/100µF	900VA/100µF	900VA/100µF	X	
Energy Saving lamps	900VA	900VA	900VA	X	
IP class	IP20	IPX0	sensor IP40 , power box IP20	IP44	
Time setting	Time 1 (for lighting): Adjustable from 5 sec to 20 min Time 2 (for HVAC): Adjustable from 10 sec to 60 min	5 sec to 20 min	Time 1 (for lighting): Adjustable from 5 sec to 20 min Time 2 (for HVAC): Adjustable from 10 sec to 60 min	5 sec to 20 min (user adjustable)	
Test Mode	Yes	Yes	Yes	Yes	
Lux setting	10 - 2000 Lux	10 - 2000 Lux	10 - 2000 Lux	Continuous from 1 Lux to full sunlight	
Operating temp range	0°C to +50°C	0°C to +45°C	0°C to +45°C	0°C to +40°C	
Connection	3-wires	3-wires	3-wires	2 wires	
Parallel connection of detectors	Yes	Yes	Yes	No	
Switching modes	Auto/Off	Manual on	X	Auto mode, manual override	
Product Dimensions	Ø111.5 x 72mm Ø111.5 x 43.5mm (flush) 68mmØ Cut-out	Ø111.5 x 59mm Ø111.5 x 30mm (flush) 65mmØ Cut-out	Ø80 x 16.5mm(H) 65mmØ Cut-out	Ø 100 x 57mm(H)	

Occupancy sensors technical overview

		Wall Mounted		Outdoor		
	E751R	GUPA1411BSS	GUP1411BSS	E750WPRGY	CCT56P004	CCT56P008
	Infrascan Single-load 120° PIR sensor	Ultimate screwless 90° PIR plate switch - with override	Ultimate screwless 90° PIR plate switch	Infrascan single-load 110° PIR sensor	Single-load 120° PIR sensor	Single-load 360° PIR sensor
	200-265V 50Hz	230V 50Hz	230V 50Hz	200-265V 50Hz	220-240V 50Hz	220-240V 50Hz
	120°	90°	90°	110°	120°	360°
	6m x 6m, 8.5m from sensor head. Head rotatable through 120°	5m at 1.2m height	5m at 1.2m height	18m at 2.4m height	12m (forward)	12m
	Ceiling (surface)	Wall (flush)	Wall (flush)	Wall or ceiling (surface)	Wall or ceiling (surface)	Wall or ceiling (surface)
	Single	Single	Single	Single	Single	Single
	X	X	X	X	X	X
	10A	150W	150W	10A	1000W	1000W
	10A	150W	150W	10A	900W	800W
	10A	150VA	150VA	10A	250VA	315VA
	10A	X	X	10A	200VA	250VA
	500W	X	X	500W	4 x 23W	4 x 23W
	IP44	X	X	IP66	IP55	IP55
	5 sec to 20 min (user adjustable)	15 sec – 30 min (through 7 time increments)	15 sec – 30 min (through 7 time increments)	5 sec to 20 min (user adjustable)	Approx 3 sec – 3 min, lower tolerance 2 – 6s	Approx 5 sec – 20 min, lower tolerance 2 – 8s
	Yes	No	No	Yes	Yes	Yes
	Continuous from 1 Lux to full sunlight	10 - 2000 Lux	10 - 2000 Lux	Continuous from 1 Lux to full sunlight	5 – 2000 Lux	5 – 2000 Lux
	0°C to +40°C	+5°C to +25°C	+5°C to +25°C	0°C to +50°C	-15°C to +40°C	-15°C to +40°C
	3-wires	2 wires	2 wires	3-wires	3-wires	3-wires
	Yes	Yes	Yes	Yes	Yes	Yes
	Auto mode, manual override	Auto mode, manual override	X	Auto mode, manual override	Auto mode, manual override	Auto mode, manual override
	Ø 100 x 57mm(H)	88 x 88mm	88 x 88mm	Mounting centres 84mm	With corner bracket 164mm (L) x 80mm (W) x 75mm (H) without corner brackets 140mm (L) x 80mm (W) x 75mm (H)	With corner bracket 170mm (L) x 88mm (W) x 76mm (H) without corner bracket 142.5mm (L) x 88mm (W) x 76mm (H)

Wiring accessories

Recommended quantity of socket outlets for domestic installation

Inadequate installations can occur when not enough socket outlets have been installed or where the existing sockets are located in the wrong areas. This could lead to potentially dangerous improvisations.

The table below summarises the recommendations of the Electrical Installation Industry Liaison Committee (EILC) regarding the minimum number of twin switched socket outlets per room, suitable for domestic installations. This takes into account likely uses and likely trends.

Room	Number of sockets	Room	Number of sockets
Kitchen	4	Landing/stairs	1
Lounge	6	Hall	1
Dining room	3	Garage	2
Double bedroom	3	Store/workroom	1
Single bed-sitting room	3	Central heating boiler point	1

Wiring circuits for 6AX and 10AX switches

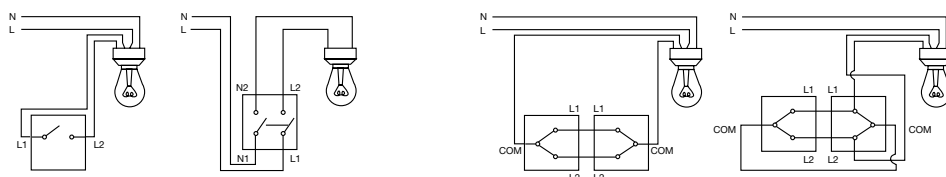

Diagram A – One way circuits

Diagram B – Two way circuits

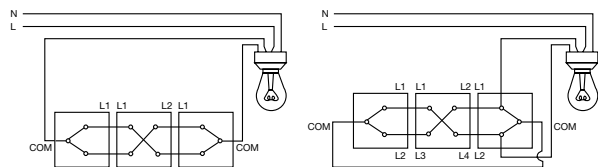

Diagram C – Intermediate circuits

Note: 1 way or 2 way switches can be replaced by dimmer switches. Rotary dimmers are 1 way only whilst Push dimmers are 2 way. LV dimmers are suitable for use on the LV input side only.

Accessories mounting box					
Product	Description	Ultimate white moulded	Exclusive white moulded	Ultimate metal plate	Exclusive metal plate
6AX/10AX plate switches	1-2 gang	16mm	16mm	16mm	25mm
	3 gang	25mm	25mm	25mm	25mm
	4-6 gang	25mm	25mm	25mm	25mm
	TP isolator	25mm	25mm	25mm	25mm
Dimmer switches	1 & 2 gang	**16mm/25mm	**16mm/25mm	25mm	25mm
	3 & 4 gang	25mm	25mm	25mm	25mm
Socket outlets	1 gang	25mm*/35mm	25mm	25mm*/35mm	25mm
	2 gang	25mm*/35mm	25mm	25mm*/35mm	25mm
	3 gang		25mm		
Round pin sockets		25mm	25mm	25mm	25mm
RCD socket outlets	1 & 2 gang		25mm		25mm
Fused connection units		25mm	25mm	35mm	25mm
Flex outlet plates		25mm	25mm		
20AX key switches		25mm	25mm	25mm	25mm
20AX DP switches		25mm	25mm	25mm	25mm
32A DP plate switches	1 gang	47mm	47mm		47mm
	2 gang	47mm	47mm	47mm	
45A DP switches	1 gang	47mm	47mm		47mm
	2 gang	47mm	47mm	47mm	
45A DP ceiling switch			47mm		
Cooker connection units		47mm	47mm	47mm	47mm
Cooker terminal box		47mm	47mm		
Shaver sockets		47mm	47mm		47mm
Telephone socket outlets	Master & secondary	25mm	25mm	25mm	25mm
Co-axial socket outlets	Single & twin	25mm	25mm	25mm	25mm
Diplex and triplex		25mm	25mm	35mm	25mm
Satellite socket		25mm	25mm	25mm	25mm
RJ45 & RJ11		35mm	35mm	35mm	35mm

Note: Metal clad accessories are supplied complete with a 42mm surface mounted box in the same matching finish. Metal plate accessories are not suitable for mounting on surface moulded pattresses.

*Dependent upon wiring configuration

**For 16mm flush fitted steel boxes use adaptor plate supplied when mounting 2 Way Ultimate slim line moulded dimmer switches

Wiring accessories

Dimmer switches

General Information:

When specifying dimmers it is advisable to obtain as much information as possible to ensure suitability and compatibility of products.

Consider the following:

- Type of lamps/lighting
- Type of control gear used in the light fittings, (if applicable) e.g. type, make and model number of transformer or ballast, etc
- Number of light fittings/load of each dimmer
- Number of circuits/dimmers
- Number of dimmers on each plate
- Number of switching positions for each circuit
- Any requirement for dimming lights from more than one position

1 gang plate size

Dimmer modules	Max.each dimmer	Min.each dimmer	Total per plate
1	250W	60W	250W
1	400W	60W	400W
1 (Electronic)	300VA	60VA	350VA
2	250W	60W	500W
2 (Electronic)	200VA	60VA	400VA

Maximum load of 400W for the plate should not be exceeded.

Dimmer modules	Max.each dimmer	Min.each dimmer	Total per plate
1	1000W	100W	1000W
3	250W	60W	750W
4	250W	60W	1000W

Maximum load of 1000W for the plate should not be exceeded.

Schneider Electric mains are NOT designed for dimming with any form of Low Voltage transformer. For this application a suitably rated Low Voltage Dimmer Switch should be used.

Maximum permitted loads in Watts for multiple dimmers in a single enclosure

Front plate gang size	2	3	4	6	8	9	12	18	24
Per row (max rating W)	400	480	480	480	480	480	480	480	480
Total plate (max rating W)	400	480	480	740	740	940	940	1440	1800

Dimmer guidelines

Moulded plate mounted dimmers can generally be used with the supplied pattress to replace standard wall switches (where a 16mm box depth is typically used). For flat plate mounted dimmers, 25mm boxes are required, except for the 1000W Electronic dimmer that requires a 47mm box. All rotary dimmer terminations and wiring are the same as for standard switches, i.e. COM, L2 (and also L1 for two-way dimmers). Rotary one-way dimmers can only be used for switching and dimming from one position. Rotary two-way (push) dimmers can be used to replace any one, (but not both), of the two-way switch circuit, (note that only one dimmer can be used per switch circuit or lamp(s); thus the lights can be switched from more than one position but can only be dimmed from one. With any rotary dimmer, if replacing an existing switch or dimmer, make a careful note of which wires are installed in which terminals on the old unit, and then connect them into the terminals with corresponding markings on the new dimmer. To ensure that plate temperatures are within maximum limits, maximum total connected load for a single size plate is 630W, and for a double size plate is 1000W. For Low Voltage lighting, remember to allow for transformer losses when calculating the total circuit load, typically 15% - 20%.

To use electronic dimmers in 1, 2 or more way circuits the circuit diagrams below and the Important Notes MUST be followed exactly.

Simulated 'Off - Click'

Recent developments within the industry have resulted in rotary dimmer modules not having the positive 'Off Click' as the dimmer is switched off. This has led to consumers returning product identifying they are not functioning. To counter this Schneider Electric have a 'simulated Off'. The range has been designed to withstand a higher inrush current than others in the market. This inrush is typical when lamps turn on for the lamps 'blow'. Typically this inrush or energy surge can be up to 100 times the normal current being supplied to a lamp. For example the inrush for a 150W lamp could be up to 40NS over 10 milliseconds. A number of dimmer products in the market when tested have a maximum capacity of approximately 20NS. The Schneider Electric product has an equivalent capacity of 50NS. This, therefore means that the Schneider Electric product will last longer within installations, depending on the switching duty. A thermal fuse protects the Schneider Electric module. This will not protect the unit against an inrush but against overloads and short-circuits etc. This fuse is not self restoring or replaceable. It's function is to protect against electrical and fire damage. This requirement was not mandatory in the previous standard and therefore some modules in circulation potentially do not have the safety feature, unlike ours.

Tungsten/Mains Voltage Tungsten Halogen Lighting

Most Tungsten lamps can be dimmed; these include standard GLS lamps, candle lamps, reflector and mains voltage Tungsten Halogen lamps etc. Tungsten lamps of mains voltage halogen type (GZ10, GU10 or G9) can be dimmed using standard Tungsten dimmers. However, to protect the dimmer, it is important to de-rate the dimmers maximum rating by 50%, (e.g. for dimmer rated as SOW- 400W, it's Tungsten Halogen lamp rating becomes SOW- 200W). This de-rating requirement only applies to Plate and Grid dimmers rated up to 1500W, for other dimmers, observe individual product guidelines. While observing maximum dimmer ratings, also ensure that the connected load is not less than the minimum rating of each dimmer, otherwise the lamps may flicker and the dimmer may fail.

Wiring accessories

1 way installation wiring diagram

IMPORTANT NOTES - for 1 Way Installation

1. Read General Installation Safety Instructions before starting work
2. Do not connect any conductor to dimmer terminal marked RS. This is for use with 2 way switching

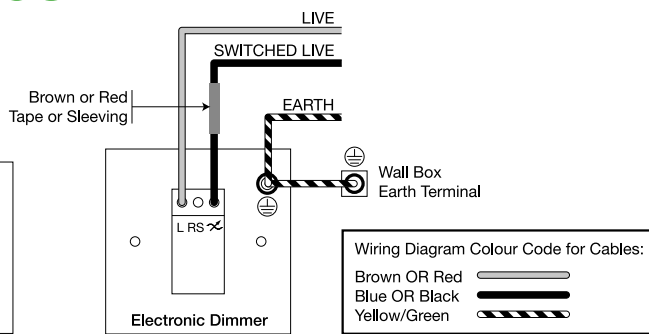

2 way and multi-way installation wiring diagram

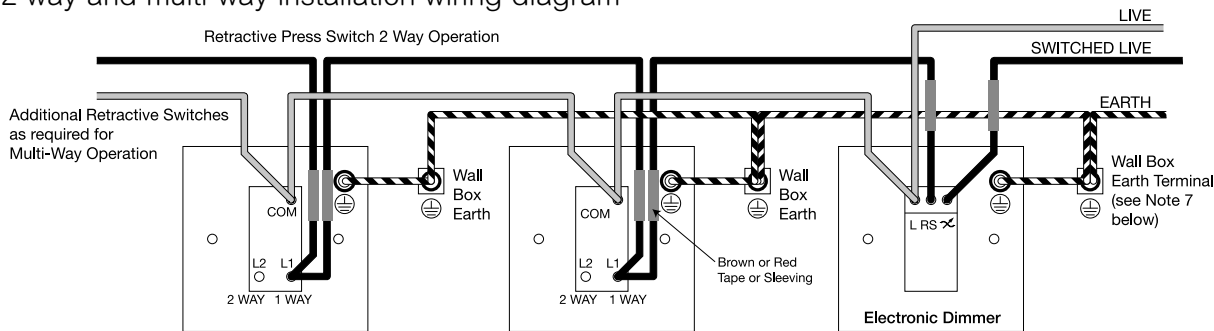

Important notes - for two way and multi - way installation

1. Read General Installation Safety Instructions before starting work.
2. Any existing 2 Way or Intermediate switches **MUST** be replaced with Retractive Press Switches.
3. Any number of Retractive Press Switches may be installed provided total cable length does not exceed 50m.
4. Either 1 Way normally open or 2 Way Retractive Push Switches may be used.
5. If 2 Way retractive switches are used, connect to Common (COM) and normally open L1 (1 WAY) terminals as shown. Do NOT use the L2 (2 WAY) terminal.
6. If replacing an existing 2 Way switch, cut back and insulate the unused 2 way wire previously connected to the L2 (2 way) terminal.
7. All Metal Wall Boxes and Metal Plate Switches must be earthed.
8. Do NOT connect more than 1 Dimmer in the same circuit,
9. Remove label covering centre terminal on rear of dimmer. This terminal is to be connected to Retractive Switch as shown in wiring diagram. Do NOT connect any other conductor to this terminal.

Circuit, lamp and other equipment compatibility

To ensure optimum performance and reliability is obtained from dimmer switches the following recommendations and precautions should be followed as appropriate to the type of dimmer:

General recommendations

Circuits

It is recommended that all lighting circuits incorporating dimmers be protected by a 6A or up to a 10A maximum Type B miniature circuit breaker.

Tungsten halogen lamps

When using mains voltage Tungsten Halogen lamps, it is essential that these types of lamp incorporate internal fuses or are constructed such that arcing at the end of life cannot occur and are from quality lamp manufacturers. The use of inferior low quality lamps is not recommended and will invalidate any guarantee or warranty supplied with the dimmer switch.

Dimmable low voltage transformers

- Always check transformer compatibility **BEFORE** installation and if in doubt always check with the dimmer Helpline or the transformer manufacturer. It is recommended that electronic dimmable transformers be loaded to at least 70% of their rated maximum wattage.
- When running multiple lamps on dimmable electronic transformers ensure that all lamps are working correctly. Replace failed lamps as soon as possible as a single failed lamp may cause flickering of all other lamps connected to the same dimmer.
- Do NOT mix electronic and magnetic transformers on the same dimmer switch.
- It is recommended that a maximum number of 5 Low Voltage transformers only should be connected to an individual dimmer switch.

Electronic dimmers

Circuits

- For two-way or more switching **ONLY** use retractive switches. Do NOT use two-way switches.
- The live supply for retractive switches must come from the live (L) connection of the dimmer.

Lamps

- Do NOT use with Compact Fluorescent Lamps (CFL) even if marked “dimmable”, Fluorescent lamps and Light Emitting Diode (LED) lamps of any description or motor loads.

Dimmable low voltage transformers

- These Electronic dimmer switches, except the 1kW, use leading edge (phase delay) dimming technology and must therefore be used with compatible good quality dimmable electronic or wire-wound (magnetic) transformers. Trailing edge (phase cut) dimmable transformers must not be used.
- The 1kW dimmer switch uses trailing edge (phase cut) dimming technology and must therefore be used with compatible good quality dimmable electronic transformers. Do not use the 1kW dimmer with magnetic transformers.

Wiring accessories

Rotary and 2 way (push) dimmers

Circuits

■ Only use two-way (push) dimmers in two-way switching circuits. Only use one two-way dimmer in a two-way switching circuit.

Lamps

■ These dimmer switches are suitable for dimming incandescent lamps and dimmable CFL lamps only and are NOT to be used with Fluorescent lamps, Light Emitting Diode (LED) lamps of any description or motor loads. Use of non-dimmable CFL lamps may permanently damage the dimmer or the lamp and will invalidate any guarantee or warranty supplied with the dimmer switch.

■ It is recommended that a maximum number of 5 dimming CFL lamps only should be connected to an individual dimmer switch.

Dimmable low voltage transformers

■ Only use Low Voltage dimmers with transformers. Do not use mains voltage dimmers.

■ The Low Voltage dimmer switches use leading edge (phase delay) dimming technology and must therefore be used with compatible good quality dimmable electronic or wire-wound transformers. Trailing edge (phase cut) dimmable transformers must not be used.

LED dimmers wiring diagrams

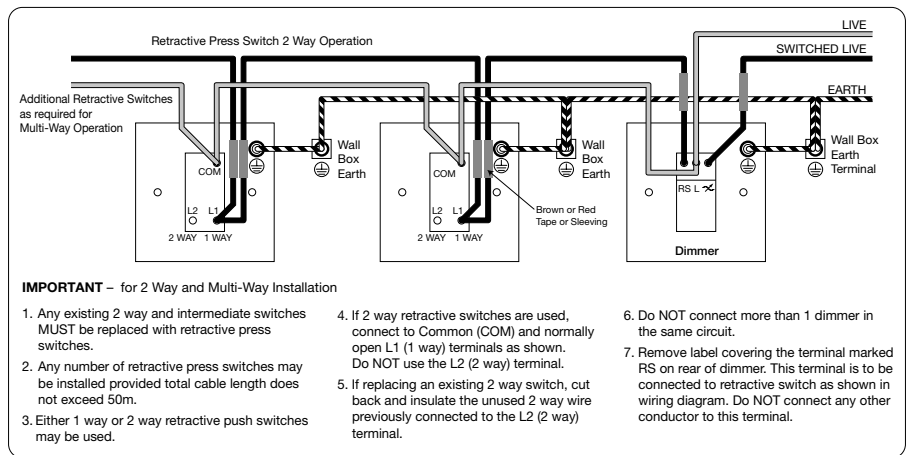
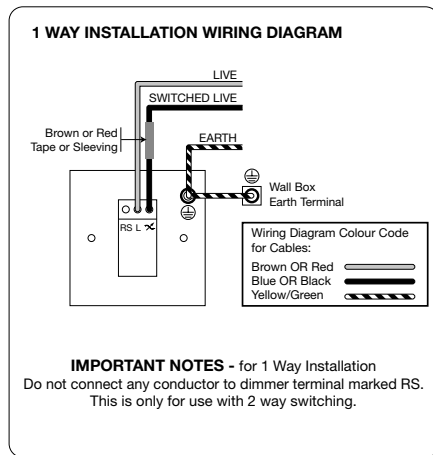

Technical specification

Rated Voltage: 220 V-230 Vac 50 Hz
(not compatible with 100-125 Vac or 60 Hz supplies)
Product standards: EN 60669-2-1

Type of ballast	Minimum Load	Maximum load
Mains voltage tungsten halogen lamp	25 W	100 W
Low voltage halogen lamp	25 W	100 W
LED lamp*	5 W	100 W

* For LED lamp compatibility please visit www.dimmer-test.com
If the LED lamp flickers at minimum dim Level, use the below procedure to set the LED lamp to a adjust and set a higher minimum dimmer position. Please note by using this procedure the minimum dim level of the LED lamp would be increased.

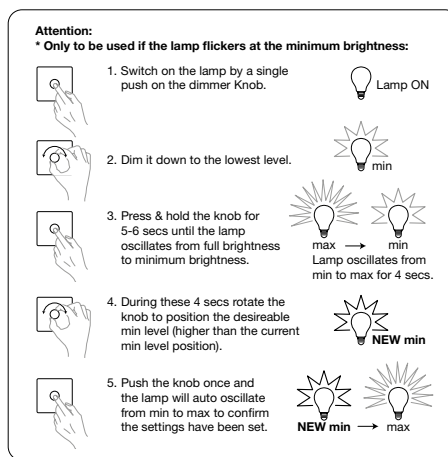

Wiring accessories

Co-Axial and Satellite sockets

Non isolated

Non-isolated products are intended for direct connection to a single or two separate TV/FM aerial downloads. These units are not designed for use in multi outlet systems.

Single TV/FM outlet for connection to a single TV or FM coaxial aerial lead.

Twin outlet for connection to each of two separate TV/FM, coaxial aerial leads.

Diplex and Triplex

Performance

Diplex

TV/FM diplex units for connection to a single coaxial aerial lead with combined TV and FM signals.

The connector standard IEC 169-2 plug for TV and IEC 169-2 socket for Radio.

Triplex

TV/FM/SAT triplex unit for connection to a single coaxial aerial lead with combined TV, FM and satellite signals.

TV: 470-860MHZ

Radio: (FM) 87.5 – 108 MHz and (DAB) 217.5 – 230 MHz.

Satellite: DC – 200kHz and 950-2300MHz.

The connector standard is 'f' for satellite, IEC 169-2 plug for TV and IEC 169-2 socket for Radio.

Telephone socket outlets

It is legal for a contractor to install a secondary telephone socket with associated wiring into house-holds with single exchange lines. The contractor may install a secondary socket and wire up to the master socket and wiring to the exchange. This does not include wiring the actual master socket or to the exchange itself. this final connection must be made by an approved installer.

For commercial and industrial installations a PBX (or PABX) internal exchange or 'intelligent' telephones are often fitted. In this case, the contractor may install all of the equipment except for the PBX unit installation. Again this must be carried out by a BSI approved installer and the interface between the PBX/PABX internal system and the incoming external lines must be connected by British Telecom.

Schneider Electric telephone sockets are suitable for use in accordance with BS 7671, formerly the 16th Edition of the IEE Wiring regulations and should be wired in accordance with the diagrams shown.

Example of typical connection

1 Connection to 2 & 5

2 Earth recall (when used) connect to terminal 4

3 Connection to terminal 3 is not usually required

NB (a) Standard 4 wire cable is shown below as incoming cable. If terminals 1 and 6 (normally unused) are required, 6 wire cable may be used.

(b) All socket outlet connections are parallel – any number of socket outlets can be connected, but it is recommended that only a maximum of 5 telephones be used at any one time on one line.

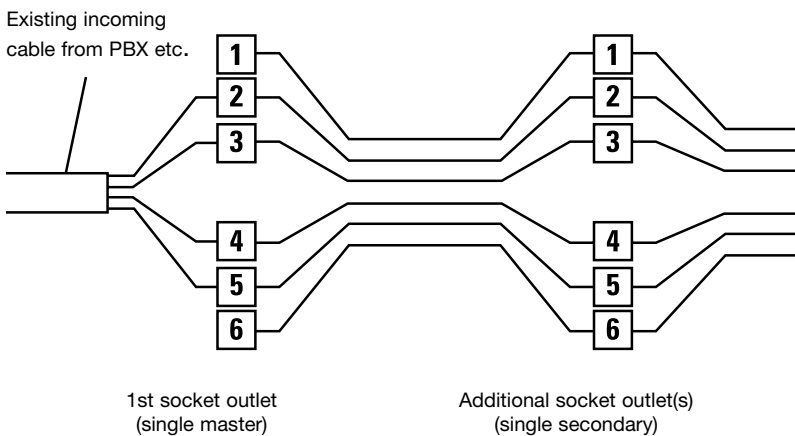

56 Series plastic chemical resistant comparison chart

Product Type (Colour)	All mounting enclosures (ie back box)	Grey transparent covers and plugs	Resistant orange (RO) covers and plug s
Acids			
Weak Solutions			
Hydrochloric	A	A	A
Nitric 10% Concentrate	A	A	A
Sulphuric Acid 100%	A	D	D
Alkalis			
Weak Solutions			
Sodium Hydroxide 10% (Caustic Soda) Concentrate	A	D	B
Potassuim Hydroxide 100%	A-B	D	D
Automotive			
Petroleum Lubricating Oils Hydraulic Oil	A	D	A
Solvents			
Aliphatic hydrocarbons (alkanes)			
Methane Propane	B A	A A	A A
Alcohols			
Ethelene Glycol Glycerol (Glycerin) Methyl Alcohol (Methanol) Ethyl Alcohol (Ethanol)	A A A A	A C D A	A B B A
Amines			
Aniline	D	D	D
Aromatic Hydrocarbons			
Methyl Benzene Xylene	D D	D D	B B
Ethers			
Dimethyl Ethyl	A	A	A
Ketones			
Acetone Acetophenone Ethyl Methyl Ketone	A D D	D D D	C C C
Miscellaneous			
Detergent Inorganic Salts Magnesium Sulphate	A A	A A	A A
Oxidising agents			
Weak Solution			
Sodium Hydrochlorite 5%	A	A	A
Strong Solution			
Hydrogen Peroxide 30%	A	A	A
Water			
Ambient Hot >60°C Steam	A C D	A A D	A B D

This table should be used as a guide only. Any end user should test to evaluate the suitability of any chemical with any plastic.

A - Excellent
Recommended no
adverse effects after
extended exposure.







B - Good
Acceptable minimal loss
of mechanical properties
after long periods of
exposure.

C - Fair
Marginal acceptability.

D - Poor
Not recommended for
use.

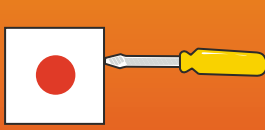





Ingress Protection ratings

PROTECTION AGAINST SOLIDS

	TEST	PROTECTION
x	No test applied	No specific protection
0	No test applied	Inherent degree of protection
1		Protected against solid objects equal to or greater than 50mm diameter. (eg. accidental contact with hand)
2		Protected against solid objects equal to or greater than 12.5mm diameter. (eg. contact with finger)
3		Protected against solid objects equal to or greater than 2.5mm diameter. (eg. tools and wires)
4		Protected against solid objects equal to or greater than 1mm diameter. (eg. fine tools and wires)
5		Protected against quantities of dust that could interfere with satisfactory operation.
6		Completely protected against dust.

Defined by IEC 60529
DIN 40050 CEI 70-1

PROTECTION AGAINST LIQUIDS

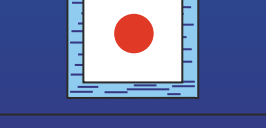
	TEST	PROTECTION
x	No test applied	No specific protection
0	No test applied	Inherent degree of protection
1		Protected against drops of water falling vertically.
2		Protected against drops of water falling at up to 15 degrees from the vertical.
3		Protected against spraying water at up to 60 degrees from the vertical.
4		Protected against splashing water from all directions.
5		Protected against jets of water from all directions.
6		Protected against jets of water of similar force to heavy seas.
7		Protected against the effects of temporary immersion.
8		Protected against the effects of continuous immersion.

Defined by IEC 60529

Index

Index

Reference	PG	Reference	PG	Reference	PG	Reference	PG	Reference	PG
400102	174	56SO332GY	192	GABAT	170	GBGS06S	164	GGBL08G	136
400104	174	56SO4326LEGY	192	GABATC	170	GBLANK1G	151	GGBL08G***	117
400112	174	56SO5166LEGY	192	GBG01	30	GBLANK2G	151	GGBL09G***	118
400113	174	56SO520LEGY	192	GBG01	30	GCKR50A	150	GGBL1011	129
400114	174	56SO5326LEGY	193	GBG01	80	GCKR50A2G	150	GGBL1011S	129
3746130	30	56SSW10LEGY	195	GBG01	80	GCKRN50A	150	GGBL1012	129
3746130	97	56SSW15LEGY	195	GBG01	98	GCKRN50A2G	150	GGBL1012***	111
3746130	136	56SSW15LERO	195	GBG01	117	GD1G1W	148	GGBL1012***S	111
3746130	151	56SSW210LEGY	195	GBG01	136	GD1G2W4C	148	GGBL1012116AS	130
5632LEGY	196	56SSW215LEGY	195	GBG01	163	GD1G2WC	148	GGBL1012A	130
5632LERO	196	56SW110GY	193	GBG01	163	GD2G2WC	148	GGBL1012ARP	130
56C31324ELGY	199	56SW110LEGY	193	GBG01P	163	GDL1	173	GGBL1012AS	130
56C3134ELGY	199	56SW110LERO	193	GBG01P	163	GDL1	173	GGBL1012R	129
56C313GY	199	56SW120LEGY	193	GBG02	80	GE115P	174	GGBL1012R***S	111
56CB4GY	196	56SW120LERO	193	GBG02	80	GE115S	175	GGBL1012RB	129
56CB4NGY	196	56SW132LEGY	193	GBG02	98	GE125P	174	GGBL1012RBS	129
56CB4NRO	196	56SW220COLEGY	195	GBG02	117	GE157P	174	GGBL1012RP	129
56E1GY	197	56SW220LEGY	194	GBG02	136	GE197P	174	GGBL1012RPS	129
56E1RO	197	56SW220LERO	194	GBG02	163	GE249P	174	GGBL1012RS	129
56E2GY	197	56SW232LEGY	194	GBG02	163	GE321P	174	GGBL1012S	129
56E2RO	197	56SW232LERO	194	GBG02	31	GE381P	174	GGBL1012W	130
56E3GY	197	56SW310LEGY	194	GBG02	31	GE84S	175	GGBL1012WB**	112
56E3RO	197	56SW320LEGY	194	GBG02P	163	GE884S	175	GGBL1012WS	130
56E4GY	198	56SW320LERO	194	GBG02P	163	GEBAT	170	GGBL1012WW**	112
56E4RO	198	56SW332LEGY	194	GBG03	80	GESPENDE613	170	GGBL1013	130
56E4VHGY	198	56SW332LERO	194	GBG03	80	GESPENDE618	170	GGBL1013***	112
56E6GY	198	56SW350LEGY	194	GBG03	98	GEURO1	152	GGBL1013***S	112
56E6RO	198	56SW363LEGY	194	GBG03	117	GEURO2	152	GGBL10131L	130
56E8GY	198	56SW363LERO	194	GBG03	136	GEURO4	152	GGBL10131R	130
56E8RO	198	ADAPT2W	174	GBG03	163	GFOPLATE	148	GGBL1013S	130
56E9GY	198	ADAPT3WF	174	GBG03	163	GGBGU30202USBRP	91	GGBL1014	129
56ED2GY	197	CRB2W	173	GBG03	31	GGBGU30202USBRP	91	GGBL1014***	111
56ES1GY	197	CSC313	186	GBG03	31	GGBGU34202USBBN14		GGBL1014***S	111
56ES2GY	197	CSO313	186	GBG04F	62	GGBGU34202USBBPB14		GGBL1014S	129
56ES2RO	197	CSO3132	186	GBG04F	98	GGBGU34202USBBPC14		GGBL1014W	130
56FA1GY	198	CSW120	186	GBG04F	118	GGBGU34202USBBSS14		GGBL1014WB**	112
56FA2GY	198	CSW1202	186	GBG04F	32	GGBGU34202USBWPC14		GGBL1014WS	130
56FA3GY	199	CSW220	186	GBG04F	32	GGBGU34202USBWPN14		GGBL1014WW**	112
56FA4GY	199	E551US	180	GBG04S	164	GGBGU34202USBWPW14		GGBL1022	129
56FCUGY	193	E55CB	182	GBG04S	164	GGBGU34202USBWSS14		GGBL1022***	112
56FCULEGY	193	E55GP	182	GBG06F	62	GGBGUE7079*	29	GGBL1022***S	112
56JB1GY	199	E55PB	181	GBG06F	62	GGBGUE7079*	59	GGBL1022A	130
56L1GY	196	E93WE	171	GBG06F	99	GGBGUE7079*	79	GGBL1022S	129
56L2GY	197	Finishes	110	GBG06F	32	GGBGUE7079*	101	GGBL1022W	130
56P310GY	196	Finishes	111	GBG06F	32	GGBGUE7079*	139	GGBL1022WB**	112
56P313EO	196	Finishes	112	GBG06S	164	GGBGUE7079*	152	GGBL1022WS	130
56P313GY	196	Finishes	114	GBG06S	164	GGBL01G	136	GGBL1022WW**	112
56P313RO	196	Finishes	115	GBGS01	163	GGBL01G***	117	GGBL102M	118
56P315GY	196	Finishes	116	GBGS01	163	GGBL02G	136	GGBL102R**	119
56PBS1LEGY	195	Finishes	117	GBGS02	163	GGBL02G***	117	GGBL102RW	137
56SO313GY	192	Finishes	118	GBGS02	163	GGBL03G	136	GGBL102W	136
56SO313LEGY	192	Finishes	119	GBGS03	163	GGBL03G***	117	GGBL1032	129
56SO313RO	192	Finishes	120	GBGS03	163	GGBL04G	136	GGBL1032***	112
56SO316110LEGY	192	G45ACCU	150	GBGS03	163	GGBL04G***	117	GGBL1032***S	112
56SO3166LEGY	192	G45ACCUN	150	GBGS04S	164	GGBL06G	136	GGBL1032S	129
56SO3326LEGY	192	G45CX	150	GBGS04S	164	GGBL06G***	117	GGBL1032W	130

Index

Reference	PG	Reference	PG	Reference	PG	Reference	PG	Reference	PG
GGBL1032WB**	112	GGBL20DPWMVHR	137	GGBL4011OVW	133	GGBL7020	134	GGBL8080**	120
GGBL1032WS	130	GGBL20DPWMW	137	GGBL4011S	133	GGBL7020***S	116	GGBL9116	139
GGBL1032WW**	112	GGBL20DPWWCL	137	GGBL4021	133	GGBL7020S	134	GGBL9116A	139
GGBL1042	130	GGBL3010	128	GGBL4021***	114	GGBL7030	134	GGBL9116S	139
GGBL1042***	112	GGBL3010***	110	GGBL4021***S	114	GGBL7030***S	116	GGBL9125	139
GGBL1042***S	112	GGBL3010***S	110	GGBL4021S	133	GGBL7030S	134	GGBL9125S	139
GGBL1042S	130	GGBL30102USBA***S111		GGBL4021SHW	133	GGBL7051	134	GGBL9147	139
GGBL10IM	118	GGBL3010D	128	GGBL4031	132	GGBL7051***S	115	GGBL9147S	139
GGBL10IW	136	GGBL3010D***	110	GGBL4050	133	GGBL7051S	134	GGBL9216A	139
GGBL12G***	118	GGBL3010D***S	110	GGBL4050S	133	GGBL7061	134	GGBL9225	139
GGBL13FCU***	119	GGBL3010DS	128	GGBL5000	132	GGBL7061***	115	GGBL9225S	139
GGBL13FCUWPPW	137	GGBL3010S	128	GGBL5000***	114	GGBL7061***S	115	GGBL9247	139
GGBL2010	131	GGBL3011D***	110	GGBL5000***S	114	GGBL7061S	134	GGBL9247S	139
GGBL2010***S	113	GGBL3016A1	129	GGBL5000AL	132	GGBL7062	134	GGBL9D25	139
GGBL2010LS	131	GGBL3016A1***	111	GGBL5000S	132	GGBL7062***	115	GGBL9D25S	139
GGBL2011	131	GGBL3020	128	GGBL5003***	114	GGBL7062***S	115	GGBLB**	119
GGBL2011***	113	GGBL3020***	110	GGBL5003***S	114	GGBL7062S	134	GGBLBW	137
GGBL2011***S	113	GGBL3020***S	110	GGBL5010	132	GGBL7071C5	134	GGBLC1GBS	117
GGBL2011S	131	GGBL30202USBA***S111		GGBL5010***	114	GGBL7071C5***S	115	GGBLC1GS	117
GGBL2014WH	131	GGBL30202USBS**	129	GGBL5010***S	114	GGBL7071C5S	134	GGBLC1GS	135
GGBL2014WH***	113	GGBL3020D	128	GGBL5010BO	133	GGBL7072C5	134	GGBLE7004	137
GGBL201M	118	GGBL3020D***	110	GGBL5010BOR	133	GGBL7072C5***S	115	GGBLE7004B	119
GGBL201W	136	GGBL3020D***S	110	GGBL5010CER	133	GGBL7072C5S	134	GGBLE7014	119
GGBL2020M	118	GGBL3020D4MP	135	GGBL5010CHR	133	GGBL7074	135	GGBLG2011	136
GGBL2020W	137	GGBL3020D4MP***	116	GGBL5010FAR	133	GGBL7074***S	116	GGBLG2011**	118
GGBL2022IMR	132	GGBL3020DS	128	GGBL5010FFR	133	GGBL707445510	135	GGBLGRDIML**	119
GGBL2022IMR**	119	GGBL3020S	128	GGBL5010FRR	133	GGBL707445510***S	116	GGBLGUE7078*	29
GGBL202K**	119	GGBL30212DS	128	GGBL5010TDR	133	GGBL707445510S	135	GGBLGUE7078*	59
GGBL202KEPWPW	137	GGBL3021D***	110	GGBL5010WMMR	133	GGBL707445511	135	GGBLGUE7078*	79
GGBL202KEPWPWEL	137	GGBL3030	128	GGBL5011	132	GGBL707445511***S	116	GGBLGUE7078*	101
GGBL202M	118	GGBL3030S	128	GGBL5011***	114	GGBL707445511S	135	GGBLGUE7078*	139
GGBL202OC**	119	GGBL3050	128	GGBL5013***	114	GGBL70746110	135	GGBLGUE7078*	152
GGBL202OCW	137	GGBL3050NS	128	GGBL5013S	132	GGBL70746110***S	116	GGBLH1GS	117
GGBL202W	136	GGBL3050NS***S	110	GGBL6011C**S	113	GGBL70746110S	135	GGBLH1GS	135
GGBL2033	132	GGBL3050S	128	GGBL6011CS	131	GGBL7074S	135	GGBLH1GSBS	117
GGBL2033S	132	GGBL3060	128	GGBL6012C**S	113	GGBL7081	135	GGBLINDWG	119
GGBL20DPCHW	137	GGBL3060***S	110	GGBL6012CS	131	GGBL7081***S	116	GGBLINDWG	138
GGBL20DPDWW	137	GGBL3060L	128	GGBL6012L**S	113	GGBL7081456	135	GGBLINDWO	119
GGBL20DPEFW	137	GGBL3060L***	110	GGBL6012LS	131	GGBL7081456***S	116	GGBLINDWO	138
GGBL20DPFAW	137	GGBL3060S	128	GGBL6012V4S	131	GGBL7081456S	135	GGBLINDWR	119
GGBL20DPFFZW	137	GGBL3070	129	GGBL6022C**S	113	GGBL7081S	135	GGBLINDWR	138
GGBL20DPFRW	137	GGBL3070***	110	GGBL6022CS	131	GGBL7090***S	114	GGBLR**	118
GGBL20DPFZW	137	GGBL3080	129	GGBL6022L**S	113	GGBL7090S	133	GGBLRBO**	118
GGBL20DPHOW	137	GGBL3080***	110	GGBL6022LS	131	GGBL8010	136	GGBLRBOT**	118
GGBL20DPHTW	137	GGBL3081	129	GGBL6022V4S	131	GGBL8010**	117	GGBLRCH**	118
GGBL20DPK**	119	GGBL3081***	110	GGBL6032C**S	113	GGBL8010**S	117	GGBLRDW**	118
GGBL20DPKEL**	119	GGBL3090	129	GGBL6032CS	131	GGBL8010S	136	GGBLREF**	118
GGBL20DPKWPW	137	GGBL3090***S	110	GGBL6032V4S	131	GGBL8020	136	GGBLRFA**	118
GGBL20DPKWPWEL	137	GGBL3090S	129	GGBL6042V4S	131	GGBL8020**	117	GGBLRFFZ**	118
GGBL20DPM	118	GGBL4001	133	GGBL70042	134	GGBL8020**S	117	GGBLRFR**	118
GGBL20DPMWW	137	GGBL4001***	114	GGBL70042***S	115	GGBL8020S	136	GGBLRFZ**	118
GGBL20DPOVW	137	GGBL4001***S	114	GGBL70042S	134	GGBL8050	138	GGBLRHO**	118
GGBL20DPTDW	137	GGBL4001S	133	GGBL7010	134	GGBL8050**	120	GGBLRHT**	118
GGBL20DPW	136	GGBL4011	133	GGBL7010***	116	GGBL8060	138	GGBLRMVHR**	118
GGBL20DPWBO	137	GGBL4011***	114	GGBL7010***S	116	GGBL8060**	120	GGBLRMW**	118
GGBL20DPWBOT	137	GGBL4011MWW	133	GGBL7010S	134	GGBL8080	138	GGBLROV**	118

Index

Reference	PG	Reference	PG	Reference	PG	Reference	PG	Reference	PG
GGBLRD**	118	GMC13SSP	161	GPULLRD	92	GU1011	91	GU1222TPN	48
GGBLRWCL**	118	GMC13SSPF	161	GRL13FCUPW	182	GU1012	91	GU1222TPW	48
GGBLRWM**	118	GMC13SSPN	161	GRL2020PW	182	GU1012A	92	GU1222TSS	48
GGBLSHF1GBS	111	GMC13SSPNF	161	GRL202KPW	182	GU1012GY	91	GU1222WPN	47
GGBLSHF1GBS	117	GMC20S	160	GRL20DPNPW	182	GU1012R	91	GU1232*PC	47
GGBLSHF1GS	111	GMC20SN	160	GRLCOPW	182	GU1012RB	91	GU1232*PW	47
GGBLSHF1GS	117	GMC50S	162	GRLDPKPW	182	GU1012RGY	91	GU1232*SS	47
GGBLSHF2GBS	111	GMC50S2N	162	GRLINDRPW	182	GU1012RP	91	GU1232BBN	47
GGBLSHF2GBS	117	GMC50SN	162	GRO	171	GU1013	92	GU1232BPB	47
GGBLSHF2GS	111	GMC51S	158	GROC	171	GU1014	91	GU1232TBN	49
GGBLSHF2GS	117	GMCB1	162	GRWH1012	92	GU1014GY	91	GU1232TPB	49
GGBLSHF2GS	129	GMCB2	162	GRWH1012GY	92	GU1022	91	GU1232TPC	49
GGBLSHF2GS	135	GMCPRCDFCU	161	GRWH1014	92	GU1022A	92	GU1232TPN	49
GGBLSIND	117	GMCPRCDSKT1G	159	GRWH1014GY	92	GU1022GY	91	GU1232TPW	49
GGBLSIND	136	GMCPRCDSKT2G	159	GRWH1022	92	GU1032	91	GU1232TSS	49
GGBLSPC1	135	GMCS1022	160	GRWH1022GY	92	GU1032GY	91	GU1232WPN	47
GGBLSPC1BS	117	GMCS1032	160	GRWH1032A	92	GU1042	91	GU1242*PC	48
GGBLSPC1FO	135	GMCS131S	158	GRWH1032GY	92	GU1062	91	GU1242*PW	48
GGBLSPC1S	117	GMCS131SS	158	GSFOPLATE	148	GU1212*PC	47	GU1242*SS	48
GGBLSPC1S	135	GMCS132S	158	GSHVSKT	150	GU1212*PW	47	GU1242BBN	48
GGBLSPC2	135	GMCS132SS	158	GSKT1G	146	GU1212*SS	47	GU1242BPB	48
GGBLSPC2BS	117	GMCS13SP	160	GSKT2A1G	146	GU1212BBN	47	GU1242TBN	49
GGBLSPC2S	117	GMCS13SPF	161	GSKT2G	146	GU1212BPB	47	GU1242TPB	49
GGBLSPC2S	135	GMCS13SPN	160	GSKT5A1G	146	GU1212R*PC	47	GU1242TPC	49
GGBLSR7004B	119	GMCS13SPNF	161	GSKTCOAX	151	GU1212R*PW	47	GU1242TPN	49
GGBLSR7004W	119	GMCS13SSP	161	GSKTCOAX2G	151	GU1212R*SS	47	GU1242TPW	49
GGBLSRU7004B	119	GMCS13SSPF	161	GSKTSW1G	146	GU1212RBBN	47	GU1242TSS	49
GGBLSRU7004W	119	GMCS13SSPN	161	GSKTSW2G2	146	GU1212RBPB	47	GU1242WPN	48
GGBLTOP13ANS	128	GMCS13SSPNF	161	GSKTSW3G	146	GU1212RWPN	47	GU1262*PC	48
GGBSB4722M	15	GMCS20S	160	GSKTSWDP1G	146	GU1212TBN	48	GU1262*PW	48
GGBSB4722M	46	GMCS20SN	160	GSKTSWDP1G2G	146	GU1212TPB	48	GU1262*SS	48
GGBSB4724M	15	GMCS50S	162	GSKTSWDP2G	146	GU1212TPC	48	GU1262BBN	48
GGBSB4724M	46	GMCS50S2N	162	GSKTSWDP2G2G	146	GU1212TPN	48	GU1262BPB	48
GJB20A	172	GMCS51S	158	GSPUR	149	GU1212TPW	48	GU1262WPN	48
GJB20ABR	172	GMCSB1	162	GSPUR3A	149	GU1212TSS	48	GU1400F	16
GJB30A	172	GMCSB2	162	GSW1G1W	147	GU1212WPN	47	GU1401F	16
GJB30ABR	172	GNSPUR	149	GSW1G2W	147	GU1213*PC	48	GU1401FW	16
GJB5A	172	GPAT1G16	153	GSW1G2WR	147	GU1213*PW	48	GU1412*PC	16
GJB5ABR	172	GPAT1G16A	102	GSW1G2WRP	147	GU1213*SS	48	GU1412*SS	16
GJB620A	172	GPAT1G16A	153	GSW2G2W	147	GU1213BBN	48	GU1412BBK	16
GJB620ABR	172	GPAT1G25	153	GSW3G2W	147	GU1213BPB	48	GU1412BBN	16
GJBN20A	172	GPAT1G47	153	GSW4G2W	147	GU1213WPN	48	GU1412BPB	16
GJBN20ABR	172	GPAT2G16A	102	GSWA1G2W	147	GU1214*PC	47	GU1412CLR	16
GJBN20AS	172	GPAT2G25	153	GSWDP20AFO	148	GU1214*PW	47	GU1412K*PC	20
GJBN20ASBR	172	GPAT2G47	153	GSWDPN20AFO	148	GU1214*SS	47	GU1412K*SS	20
GLHC	171	GPAT2GC25	153	GSWINT	147	GU1214BBN	47	GU1412KBBN	20
GMC1022	160	GPAT3G25	153	GSWISO2	147	GU1214BPB	47	GU1412KBPB	20
GMC1032	160	GPATDG25	153	GSWNSPUR	149	GU1214WPN	47	GU1412KWPN	20
GMC131S	158	GPEND62	170	GSWPULL6	171	GU1222*PC	47	GU1412KWPN	20
GMC131SS	158	GPEND6C2	170	GSWPULL62	171	GU1222*PW	47	GU1412R*PC	16
GMC132S	158	GPEND92	170	GSWSPUR	149	GU1222*SS	47	GU1412R*SS	16
GMC132SS	158	GPEND9C2	170	GSWTPS	147	GU1222BBN	47	GU1412RBBN	16
GMC13SP	160	GPRCDFCU	149	GTELMAS	151	GU1222BPB	47	GU1412RBPB	16
GMC13SPF	161	GPRCDSKT1G	146	GTELRJ11	151	GU1222TBN	48	GU1412RWPN	16
GMC13SPN	160	GPRCDSKT2G	146	GTELRJ45	151	GU1222TPB	48	GU1412RWPW	16
GMC13SPNF	161	GPULLGY	92	GTELSEC	151	GU1222TPC	48	GU1412TBN	19

Index

Reference	PG	Reference	PG	Reference	PG	Reference	PG	Reference	PG
GU1412TCLR	19	GU1442*PC	17	GU2211WPN	52	GU3010	90	GU3220WPN	44
GU1412TPB	19	GU1442*SS	17	GU2211WPW	52	GU3010D	90	GU3220WPW	44
GU1412TPC	19	GU1442BBN	17	GU2213*PC	52	GU3010DGY	90	GU3231*PC	45
GU1412TPN	19	GU1442BPB	17	GU2213*SS	52	GU3010DRD	90	GU3231*SS	45
GU1412TPW	19	GU1442TBN	19	GU2213BBN	52	GU3011	90	GU3231BBN	45
GU1412TSS	19	GU1442TPB	19	GU2213BPB	52	GU3020	90	GU3231WPW	45
GU1412WPN	16	GU1442TPC	19	GU2213WPN	52	GU3020D	90	GU3234*SS	45
GU1412WPW	16	GU1442TPN	19	GU2213WPW	52	GU3021	90	GU3234WPC	45
GU1412WWH	16	GU1442TPW	19	GU2214 BPB	52	GU3030	90	GU3250*PC	44
GU1413*PC	18	GU1442TSS	19	GU2214*PC	52	GU3030GY	90	GU3250*SS	44
GU1413*SS	18	GU1442WPN	17	GU2214*SS	52	GU3030RD	90	GU3250BBN	44
GU1413BBK	18	GU1442WPW	17	GU2214BBN	52	GU3031	90	GU3250BPB	44
GU1413BBN	18	GU1462*PC	17	GU2214WH*PC	52	GU3032	90	GU3250WPN	44
GU1413BPB	18	GU1462*SS	17	GU2214WH*SS	52	GU3033	90	GU3250WPW	44
GU1413WPN	18	GU1462BBN	17	GU2214WHBBN	52	GU3034	90	GU3251*PC	45
GU1413WPW	18	GU1462BPB	17	GU2214WHBPB	52	GU3050	90	GU3251*SS	45
GU1414*PC	16	GU1462WPN	17	GU2214WHWPN	52	GU3060	90	GU3251BBN	45
GU1414*SS	16	GU1462WPW	17	GU2214WHWPW	52	GU3060RD	90	GU3251BPB	45
GU1414BBN	16	GU1512*BC	74	GU2214WPN	52	GU3070	91	GU3251WPN	45
GU1414BPB	16	GU1512*PC	74	GU2214WPW	52	GU3080	91	GU3251WPW	45
GU1414TBN	19	GU1513*BC	75	GU2410*PC	23	GU3090	91	GU3252*PC	45
GU1414TPB	19	GU1513*PC	75	GU2410*SS	23	GU3091	91	GU3252*SS	45
GU1414TPC	19	GU1514*BC	74	GU2410BBN	23	GU3210*PC	44	GU3252BBN	45
GU1414TPW	19	GU1514*PC	74	GU2410BPB	23	GU3210*SS	44	GU3252BPB	45
GU1414TSS	19	GU1522*BC	74	GU2410CLR	23	GU3210BBN	44	GU3252WPN	45
GU1414WPN	16	GU1522*PC	74	GU2410WPN	23	GU3210BPB	44	GU3252WPW	45
GU1414WPW	16	GU1532*BC	75	GU2410WPW	23	GU3210D*PC	44	GU3260*PC	44
GU1422*PC	17	GU1532*PC	75	GU2411*PC	23	GU3210D*SS	44	GU3260*SS	44
GU1422*SS	17	GU1542*BC	75	GU2411*SS	23	GU3210DBBN	44	GU3260BBN	44
GU1422BBK	17	GU1542*PC	75	GU2411BBK	23	GU3210DBPB	44	GU3260BPB	44
GU1422BBN	17	GU2003	94	GU2411BBN	23	GU3210DWPN	44	GU3260WPN	44
GU1422BPB	17	GU2010	93	GU2411BPB	23	GU3210DWPW	44	GU3260WPW	44
GU1422CLR	17	GU2010GY	93	GU2411WPN	23	GU3210WPN	44	GU3270*PC	46
GU1422TBN	19	GU2010HT	93	GU2411WPW	23	GU3210WPW	44	GU3270*PW	46
GU1422TCLR	19	GU2010OV	93	GU2411WWH	23	GU3220 BPB	44	GU3270*SS	46
GU1422TPB	19	GU2011	93	GU2413*PC	23	GU3220*PC	44	GU3270BBN	46
GU1422TPC	19	GU2011HT	93	GU2413*SS	23	GU3220*SS	44	GU3270BPB	46
GU1422TPN	19	GU2011OV	93	GU2413BBN	23	GU32202DMP*PC	46	GU3270WPN	46
GU1422TPW	19	GU2011TR	93	GU2413BPB	23	GU32202DMP*SS	46	GU3280*PC	46
GU1422TSS	19	GU2013	93	GU2413WPN	23	GU32202DMPBBN	46	GU3280*PW	46
GU1422WPN	17	GU2013HT	93	GU2413WPW	23	GU32202DMPBPB	46	GU3280*SS	46
GU1422WPW	17	GU2013TR	93	GU2414*PC	23	GU32202DMPWPN	46	GU3280BBN	46
GU1432*PC	17	GU2014	93	GU2414*SS	23	GU32202DMPWPW	46	GU3280BPB	46
GU1432*SS	17	GU2014HT	93	GU2414BBN	23	GU32204DMP*PC	46	GU3280WPN	46
GU1432BBN	17	GU2014WH	93	GU2414BPB	23	GU32204DMP*SS	46	GU3290*PC	46
GU1432BPB	17	GU2033	94	GU2414WH*PC	24	GU32204DMPBBN	46	GU3290*PW	46
GU1432CLR	17	GU2210*PC	52	GU2414WH*SS	24	GU32204DMPBPB	46	GU3290*SS	46
GU1432TBN	19	GU2210*SS	52	GU2414WHBBN	24	GU32204DMPWPN	46	GU3290BBN	46
GU1432TPB	19	GU2210BBN	52	GU2414WHBPB	24	GU32204DMPWPW	46	GU3290BPB	46
GU1432TPC	19	GU2210BPB	52	GU2414WHWPW	24	GU3220BBN	44	GU3290WPN	46
GU1432TPN	19	GU2210WPN	52	GU2414WPN	23	GU3220D*PC	45	GU3410*PC	12
GU1432TPW	19	GU2210WPW	52	GU2414WPW	23	GU3220D*SS	45	GU3410*SS	12
GU1432TSS	19	GU2211*PC	52	GU2511*BC	76	GU3220DBBN	45	GU3410BBN	12
GU1432WPN	17	GU2211*SS	52	GU2511*PC	76	GU3220DBPB	45	GU3410BPB	12
GU1432WPW	17	GU2211BBN	52	GU2513*BC	76	GU3220DWPN	45	GU3410BPB	12
		GU2211BPB	52	GU2513*PC	76	GU3220DWPW	45	GU3410CLR	12

Index

Reference	PG	Reference	PG	Reference	PG	Reference	PG	Reference	PG
GU3410D*PC	12	GU3460*PC	12	GU4231*PC	53	GU5010RD	95	GU5214WPW	54
GU3410D*SS	12	GU3460*SS	12	GU4231*SS	53	GU5010TD	95	GU5400*PC	24
GU3410DBBK	12	GU3460BBN	12	GU4231BBN	53	GU5010WD	95	GU5400*SS	24
GU3410DBBN	12	GU3460BPB	12	GU4231BPB	53	GU5011	95	GU5400BBN	24
GU3410DWPN	12	GU3460WPN	12	GU4231WPN	53	GU5011BO	95	GU5400BPB	24
GU3410DWPW	12	GU3460WPW	12	GU4231WPW	53	GU5011CH	95	GU5400WPN	24
GU3410DWWH	12	GU3470*PC	14	GU4401*PC	26	GU5011DW	95	GU5400WPW	24
GU3410WPN	12	GU3470*SS	14	GU4401*SS	26	GU5011EF	95	GU5403*PC	24
GU3410WPW	12	GU3470BBN	14	GU4401BBK	26	GU5011FA	95	GU5403*SS	24
GU3411D*PC	13	GU3470BPB	14	GU4401BBN	26	GU5011FFZ	95	GU5403BBN	24
GU3411D*SS	13	GU3470WPN	14	GU4401BPB	26	GU5011FR	95	GU5403BPB	24
GU3411DBBN	13	GU3470WPW	14	GU4401WPN	26	GU5011FZ	95	GU5403WPN	24
GU3411DWPN	13	GU3480*PC	14	GU4401WPW	26	GU5011GY	95	GU5403WPW	24
GU3411DWPW	13	GU3480*SS	14	GU4401WWH	26	GU5011HO	95	GU5410*PC	25
GU3420*PC	13	GU3480BBN	14	GU4421*PB	26	GU5011HT	95	GU5410*SS	25
GU3420*SS	13	GU3480BPB	14	GU4421*PC	26	GU5011MW	95	GU5410BBN	25
GU34202DMP*PB	15	GU3480WPN	14	GU4421*SS	26	GU5011TD	95	GU5410BPB	25
GU34202DMP*PC	15	GU3480WPW	14	GU4421BBN	26	GU5011WD	95	GU5410CLR	25
GU34202DMP*SS	15	GU3480WWH	14	GU4421WPN	26	GU5011WM	95	GU5410WPN	25
GU34202DMPBBN	15	GU3490*PC	15	GU4421WPW	26	GU5013	95	GU5410WPW	25
GU34202DMPWPN	15	GU3490*SS	15	GU4431*PC	24	GU5014	95	GU5411*PC	25
GU34202DMPWPW	15	GU3490BBN	15	GU4431*SS	24	GU5200*PC	53	GU5411*SS	25
GU34204DMP*PC	15	GU3490BPB	15	GU4431BBN	24	GU5200*SS	53	GU5411BBK	25
GU34204DMP*SS	15	GU3490WPN	15	GU4431BPB	24	GU5200BBN	53	GU5411BBN	25
GU34204DMPBBN	15	GU3490WPW	15	GU4431WPN	24	GU5200BPB	53	GU5411BPB	25
GU34204DMPBPB	15	GU3510*BC	74	GU4431WPW	24	GU5200WPN	53	GU5411WPN	25
GU34204DMPWPN	15	GU3510*PC	74	GU4501*BC	77	GU5200WPW	53	GU5411WPW	25
GU34204DMPWPW	15	GU3520*BC	74	GU4501*PC	77	GU5203*PC	53	GU5411WWH	25
GU3420BBN	13	GU3520*PC	74	GU4521*BC	77	GU5203*SS	53	GU5413*PC	25
GU3420BPB	13	GU3530*BC	74	GU4521*PC	77	GU5203BBN	53	GU5413*SS	25
GU3420CLR	13	GU3530*PC	74	GU5000	94	GU5203BPB	53	GU5413BBN	25
GU3420D*PC	13	GU3580*BC	74	GU50003	94	GU5203WPN	53	GU5413BPB	25
GU3420D*SS	13	GU3580*PC	74	GU5000HT	94	GU5203WPW	53	GU5413WPN	25
GU3420DBBN	13	GU3631GMC	158	GU5000MW	94	GU5210*PC	53	GU5413WPW	25
GU3420DBPB	13	GU4000	96	GU5000RD	94	GU5210*SS	53	GU5414*PC	25
GU3420DWPN	13	GU4000GY	96	GU5000SS	94	GU5210BBN	53	GU5414*SS	25
GU3420DWPW	13	GU4001	96	GU5000TD	94	GU5210BPB	53	GU5414BBN	25
GU3420DWWH	13	GU4010	96	GU5000TR	94	GU5210WPN	53	GU5414BPB	25
GU3420WPN	13	GU4011	96	GU5000WD	94	GU5210WPW	53	GU5414WPN	25
GU3420WPW	13	GU4020	96	GU5001	94	GU5211*PC	54	GU5414WPW	25
GU3421D*SS	13	GU4020GY	96	GU5003	94	GU5211*SS	54	GU5500*BC	76
GU3421DBBN	13	GU4021	96	GU50033	94	GU5211BBN	54	GU5500*PC	76
GU3421DBPB	13	GU4031	94	GU5003TR	94	GU5211BPB	54	GU5510*BC	76
GU3421DWPN	13	GU4050	96	GU5010	95	GU5211WPN	54	GU5510*PC	76
GU3421DWPW	13	GU4201*PC	55	GU5010BO	95	GU5211WPW	54	GU5511*BC	76
GU3431*PC	13	GU4201*SS	55	GU5010CH	95	GU5213 BPB	54	GU5511*PC	76
GU3431*SS	13	GU4201BBN	55	GU5010DW	95	GU5213*PC	54	GU5514*BC	76
GU3431WPW	13	GU4201BPB	55	GU5010EF	95	GU5213*SS	54	GU5514*PC	76
GU3431WWH	13	GU4201WPN	55	GU5010FA	95	GU5213BBN	54	GU6000RC1R	22
GU3434*SS	14	GU4201WPW	55	GU5010FFZ	95	GU5213WPN	54	GU6000RC1R	38
GU3434WPC	14	GU4221*PC	55	GU5010FR	95	GU5213WPW	54	GU6000RC1R	69
GU3450*PC	12	GU4221*SS	55	GU5010FZ	95	GU5214*PC	54	GU6000RC1R	85
GU3450*SS	12	GU4221BBN	55	GU5010GY	95	GU5214*SS	54	GU6012C	93
GU3450BBN	12	GU4221BPB	55	GU5010HO	95	GU5214BBN	54	GU6012L	93
GU3450WPN	12	GU4221WPN	55	GU5010HT	95	GU5214BPB	54	GU6022C	93
GU3450WPW	12	GU4221WPW	55	GU5010MW	95	GU5214WPN	54	GU6022L	93

Index

Reference	PG	Reference	PG	Reference	PG	Reference	PG	Reference	PG
GU6032C	93	GU6242CBN	50	GU6432CPC	21	GU7230BPB	57	GU7461*PC	27
GU6032L	93	GU6242CPB	50	GU6432CPN	21	GU7230WPN	57	GU7461*SS	27
GU6042C	93	GU6242CPC	50	GU6432CPW	21	GU7230WPW	57	GU7461BBN	27
GU6042L	93	GU6242CPN	50	GU6432CSS	21	GU7251*SS	56	GU7461WPN	27
GU6212CBN	49	GU6242CPW	50	GU6432LBN	21	GU7251BBN	56	GU7461WPW	27
GU6212CPB	49	GU6242CSS	50	GU6432LPB	21	GU7251BPB	56	GU7461WWH	27
GU6212CPC	49	GU6242LBN	51	GU6432LPC	21	GU7251WPC	56	GU7462*PC	27
GU6212CPN	49	GU6242LPB	51	GU6432LPN	21	GU7251WPN	56	GU7462*SS	27
GU6212CPW	49	GU6242LPC	51	GU6432LPW	21	GU7251WPW	56	GU7462BBN	27
GU6212CSS	49	GU6242LPN	51	GU6432LSS	21	GU7261*PC	56	GU7462BPB	27
GU6212E*PC	51	GU6242LPW	51	GU6442CBN	21	GU7261*SS	56	GU7462BPB	27
GU6212E*SS	51	GU6242LSS	51	GU6442CPB	21	GU7261BBN	56	GU7462WPN	27
GU6212EBBN	51	GU6412CBN	20	GU6442CPC	21	GU7261BPB	56	GU7462WPW	27
GU6212EBPB	51	GU6412CPB	20	GU6442CPN	21	GU7261WPN	56	GU7462WWH	27
GU6212EWPN	51	GU6412CPC	20	GU6442CPW	21	GU7261WPW	56	GU7471*PC	27
GU6212LBN	50	GU6412CPN	20	GU6442CSS	21	GU7262*PC	56	GU7471*SS	27
GU6212LPB	50	GU6412CPW	20	GU6442LBN	22	GU7262*SS	56	GU7471BBK	27
GU6212LPC	50	GU6412CSS	20	GU6442LPB	22	GU7262BBN	56	GU7471BBN	27
GU6212LPN	50	GU6412E*PC	22	GU6442LPC	22	GU7262BPB	56	GU7471BPB	27
GU6212LPW	50	GU6412E*SS	22	GU6442LPN	22	GU7262WPN	56	GU7471WPN	27
GU6212LSS	50	GU6412EBBN	22	GU6442LPW	22	GU7262WPW	56	GU7471WPW	27
GU6212R*SS	51	GU6412EBPB	22	GU6442LSS	22	GU7271*PC	56	GU7471WWH	27
GU6212RBBN	51	GU6412EWPN	22	GU6512CBC	75	GU7271*SS	56	GU7490*PC	26
GU6212RBPC	51	GU6412EWPW	22	GU6512CPC	75	GU7271BBN	56	GU7490*SS	26
GU6212RWPN	51	GU6412LBN	21	GU6522CBC	75	GU7271BPB	56	GU7490BBK	26
GU6212RWPN	51	GU6412LPB	21	GU6522CPC	75	GU7271WPN	56	GU7490BBN	26
GU6222CBN	49	GU6412LPC	21	GU6532CBC	75	GU7271WPW	56	GU7490BPB	26
GU6222CPB	49	GU6412LPN	21	GU6532CPC	75	GU7290*PC	55	GU7490WPN	26
GU6222CPC	49	GU6412LPW	21	GU7010	97	GU7290*SS	55	GU7490WPW	26
GU6222CPN	49	GU6412LSS	21	GU7020	97	GU7290BBN	55	GU7490WWH	26
GU6222CPW	49	GU6412R*PC	22	GU7021	97	GU7290BPB	55	GU7510*BC	78
GU6222CSS	49	GU6412R*SS	22	GU7030	97	GU7290WPN	55	GU7510*PC	78
GU6222E BPB	51	GU6412RBBN	22	GU7040	97	GU7290WPW	55	GU7561*BC	77
GU6222E*PC	51	GU6412RBPB	22	GU7051	96	GU7410*PC	28	GU7561*PC	77
GU6222E*SS	51	GU6412RWPN	22	GU7061	96	GU7410*SS	28	GU7562*BC	77
GU6222EBBN	51	GU6412RWPN	22	GU7062	96	GU7410BBN	28	GU7562*PC	77
GU6222EWPN	51	GU6422CBN	20	GU7071	97	GU7410BPB	28	GU7590*BC	77
GU6222EWPW	51	GU6422CPB	20	GU7072	97	GU7410WP	28	GU7590*PC	77
GU6222LBN	50	GU6422CPC	20	GU7081	97	GU7410WPW	28	GU8010	97
GU6222LPB	50	GU6422CPN	20	GU7090	96	GU7420*PC	28	GU8020	97
GU6222LPC	50	GU6422CPW	20	GU7090GY	96	GU7420*SS	28	GU8050	101
GU6222LPN	50	GU6422CSS	20	GU7210*PC	57	GU7420BBN	28	GU8050GY	101
GU6222LPW	50	GU6422E*SS	22	GU7210*SS	57	GU7420WPN	28	GU8060	101
GU6222LSS	50	GU6422EBBN	22	GU7210BBN	57	GU7420WPW	28	GU8060GY	101
GU6232CBN	50	GU6422EBPB	22	GU7210BPB	57	GU7430*PC	28	GU8080	101
GU6232CPB	50	GU6422EBPC	22	GU7210WPN	57	GU7430*SS	28	GU8080GY	101
GU6232CPC	50	GU6422EWPN	22	GU7210WPW	57	GU7430BBN	28	GU8250BN	58
GU6232CPN	50	GU6422EWPW	22	GU7220*PC	57	GU7430BPB	28	GU8250PB	58
GU6232CPW	50	GU6422LBN	21	GU7220*SS	57	GU7430WPN	28	GU8250PC	58
GU6232CSS	50	GU6422LPB	21	GU7220BBN	57	GU7430WPW	28	GU8250PN	58
GU6232LBN	50	GU6422LPC	21	GU7220BPB	57	GU7451*PC	27	GU8250PW	58
GU6232LPB	50	GU6422LPN	21	GU7220WPN	57	GU7451*SS	27	GU8250SS	58
GU6232LPC	50	GU6422LPW	21	GU7220WPW	57	GU7451BBN	27	GU8260BN	58
GU6232LPN	50	GU6422LSS	21	GU7230*PC	57	GU7451BPB	27	GU8260PB	58
GU6232LPW	50	GU6432CBN	21	GU7230*SS	57	GU7451WPN	27	GU8260PC	58
GU6232LSS	50	GU6432CPB	21	GU7230BBN	57	GU7451WPW	27	GU8260PN	58

Index

Reference	PG	Reference	PG	Reference	PG	Reference	PG	Reference	PG
GU8260PW	58	GUE7001*	79	GUE7061*	120	GUE7077*	152	GUG101M*	33
GU8260SS	58	GUE7001*	120	GUE7061*	29	GUE7081*	29	GUG101M*	63
GU8280BN	58	GUE7001*	59	GUE7061*	79	GUE7081*	79	GUG101M*	81
GU8280PB	58	GUE7001W	101	GUE7061W	101	GUE7081*	120	GUG101W	99
GU8280PC	58	GUE7001W	138	GUE7061W	138	GUE7081*	59	GUG101W	165
GU8280PN	58	GUE7001W	152	GUE7061W	152	GUE7081W	101	GUG102M*	33
GU8280PW	58	GUE7010*	120	GUE7062*K	29	GUE7081W	139	GUG102M*	63
GU8280SS	58	GUE7010*	29	GUE7062*K	59	GUE7081W	152	GUG102M*	81
GU8410BN	30	GUE7010*	79	GUE7062*K	79	GUE7082*	29	GUG102R*MS	35
GU8410PB	30	GUE7010*	59	GUE7062*K	120	GUE7082*	79	GUG102R*MS	65
GU8410PC	30	GUE7010W	101	GUE7062WK	101	GUE7082*	120	GUG102R*MS	82
GU8410PN	30	GUE7010W	139	GUE7062WK	138	GUE7082*	59	GUG102R*PB	35
GU8410PW	30	GUE7010W	152	GUE7062WK	152	GUE7082W	101	GUG102R*PB	65
GU8410SS	30	GUE7011*	29	GUE7071*	120	GUE7082W	139	GUG102R*SS	35
GU8420BN	30	GUE7011*	59	GUE7071*	29	GUE7082W	152	GUG102R*SS	65
GU8420PB	30	GUE7011*	79	GUE7071*	59	GUE7091*	120	GUG102RBBN	35
GU8420PC	30	GUE7011*	120	GUE7071*	79	GUE7091*	29	GUG102RBBN	65
GU8420PN	30	GUE7011W	101	GUE7071W	101	GUE7091*	59	GUG102RBLK	82
GU8420PW	30	GUE7011W	138	GUE7071W	138	GUE7091*	79	GUG102RW	100
GU8420SS	30	GUE7011W	152	GUE7071W	152	GUE7091W	101	GUG102RW	165
GU8450BN	28	GUE7012*	29	GUE7072*	120	GUE7091W	138	GUG102RWPN	35
GU8450PB	28	GUE7012*	59	GUE7072*	29	GUE7091W	152	GUG102RWPN	65
GU8450PC	28	GUE7012*	79	GUE7072*	59	GUE8010*	29	GUG102RWPW	35
GU8450PN	28	GUE7012*	120	GUE7072*	79	GUE8010*	59	GUG102RWPW	65
GU8450PW	28	GUE7012W	101	GUE7072W	101	GUE8010*	79	GUG102RWPW	82
GU8450SS	28	GUE7012W	138	GUE7072W	138	GUE8010*	120	GUG102T*MS	35
GU8480BN	29	GUE7012W	152	GUE7072W	152	GUE8010W	101	GUG102T*MS	65
GU8480PB	29	GUE7020*	120	GUE7073*	29	GUE8010W	138	GUG102T*MS	83
GU8480PC	29	GUE7020*	29	GUE7073*	59	GUE8010W	152	GUG102T*PB	35
GU8480PN	29	GUE7020*	79	GUE7073*	79	GUG01G	98	GUG102T*PB	65
GU8480PW	29	GUE7020*	59	GUE7073W	101	GUG01GGY	98	GUG102T*SS	35
GU8480SS	29	GUE7020W	101	GUE7073W	152	GUG01GMC	163	GUG102T*SS	65
GU8510BC	79	GUE7020W	139	GUE7074*	29	GUG01GSMC	163	GUG102TBBN	35
GU8510PC	79	GUE7020W	152	GUE7074*	59	GUG01GSMC	163	GUG102TBBN	65
GU8550BC	78	GUE7030*	29	GUE7074*	79	GUG02G	98	GUG102TWPN	35
GU8550PC	78	GUE7030*	79	GUE7074W	101	GUG02GGY	98	GUG102TWPN	65
GU8560BC	78	GUE7030*	120	GUE7074W	139	GUG02GMC	163	GUG102TWPW	35
GU8560PC	78	GUE7030*	59	GUE7074W	152	GUG02GSMC	163	GUG102TWPW	65
GU8580BC	78	GUE7030W	101	GUE7075*	29	GUG03G	98	GUG102TWPW	83
GU8580PC	78	GUE7030W	138	GUE7075*	79	GUG03GGY	98	GUG102W	99
GU9116	102	GUE7030W	152	GUE7075*	120	GUG03GMC	163	GUG102W	165
GU9125	102	GUE7040*	29	GUE7075*	59	GUG03GSMC	163	GUG101M*	33
GU9135	102	GUE7040*	79	GUE7075W	101	GUG04G	98	GUG101M*	63
GU9147	102	GUE7040*	120	GUE7075W	138	GUG04GGY	98	GUG101M*	81
GU9225	102	GUE7040*	59	GUE7075W	152	GUG04GMC	163	GUG101T*MS	35
GU9235	102	GUE7040W	101	GUE7076*	29	GUG06G	98	GUG101T*MS	65
GU9247	102	GUE7040W	139	GUE7076*	59	GUG06GGY	98	GUG101T*MS	83
GU9D25	102	GUE7040W	152	GUE7076*	79	GUG06GMC	163	GUG101T*PB	35
GUE7000*	120	GUE7051*	29	GUE7076*	101	GUG06GSMC	163	GUG101T*PB	65
GUE7000*	29	GUE7051*	59	GUE7076*	139	GUG08G	98	GUG101T*SS	35
GUE7000*	79	GUE7051*	79	GUE7076*	152	GUG08GGY	98	GUG101T*SS	65
GUE7000*	59	GUE7051*	120	GUE7077*	29	GUG08GMC	163	GUG101TBBN	35
GUE7000W	101	GUE7051W	101	GUE7077*	59	GUG08GSMC	163	GUG101TBBN	65
GUE7000W	138	GUE7051W	138	GUE7077*	79	GUG09G	98	GUG101TWPN	35
GUE7000W	152	GUE7051W	152	GUE7077*	101	GUG09GMC	164	GUG101TWPN	65
GUE7001*	29	GUE7061*	59	GUE7077*	139	GUG09GSMC	164	GUG101TWPN	35

Index

Reference	PG	Reference	PG	Reference	PG	Reference	PG	Reference	PG
GUGINDWR	70	GUGRCHPN	64	GUGRFAPN	64	GUGRFZPW	64	GUGRJ11WPN	67
GUGINDWR	86	GUGRCHPW	34	GUGRFAPW	34	GUGRFZPW	82	GUGRJ11WPW	37
GUGINDWR	100	GUGRCHPW	64	GUGRFAPW	64	GUGRFZSS	34	GUGRJ11WPW	67
GUGINDWR	165	GUGRCHPW	82	GUGRFAPW	82	GUGRFZSS	64	GUGRJ11WPW	84
GUGL01BC	80	GUGRCHSS	34	GUGRFASS	34	GUGRFZSS	82	GUGRJ11WPW	100
GUGL01PC	80	GUGRCHSS	64	GUGRFASS	64	GUGRHEBLK	34	GUGRJ11WPW	166
GUGL02BC	80	GUGRCHSS	82	GUGRFASS	82	GUGRHEBLK	64	GUGRJ45*MS	68
GUGL02PC	80	GUGRDWBLK	34	GUGRFRBLK	34	GUGRHEBLK	82	GUGRJ45*MS	84
GUGL03BC	80	GUGRDWBLK	64	GUGRFRBLK	64	GUGRHEBN	34	GUGRJ45*PB	68
GUGL03PC	80	GUGRDWBLK	82	GUGRFRBLK	82	GUGRHEBN	64	GUGRJ45*SS	68
GUGL04BC	80	GUGRDWBN	34	GUGRFRBN	34	GUGRHEMS	34	GUGRJ45BBN	68
GUGL04PC	80	GUGRDWBN	64	GUGRFRBN	64	GUGRHEMS	64	GUGRJ45BLK	84
GUGL06BC	80	GUGRDWMS	34	GUGRFRFZBLK	34	GUGRHEMS	82	GUGRJ45WPN	68
GUGL06PC	80	GUGRDWMS	64	GUGRFRFZBLK	64	GUGRHEPB	34	GUGRJ45WPW	68
GUGL08BC	80	GUGRDWMS	82	GUGRFRFZBLK	82	GUGRHEPB	64	GUGRJ45WPW	84
GUGL08PC	80	GUGRDWPB	34	GUGRFRFZBN	34	GUGRHEPN	34	GUGRJ45WPW	100
GUGRBLK	34	GUGRDWPB	64	GUGRFRFZBN	64	GUGRHEPN	64	GUGRJ45WPW	166
GUGRBLK	64	GUGRDWPN	34	GUGRFRFZMS	34	GUGRHEPW	34	GUGRMS	34
GUGRBLK	82	GUGRDWPN	64	GUGRFRFZMS	64	GUGRHEPW	64	GUGRMS	64
GUGRBN	34	GUGRDWPW	34	GUGRFRFZMS	82	GUGRHEPW	82	GUGRMS	82
GUGRBN	64	GUGRDWPW	64	GUGRFRFZPB	34	GUGRHESS	34	GUGRMWBLK	34
GUGRBOBLK	34	GUGRDWPW	82	GUGRFRFZPB	64	GUGRHESS	64	GUGRMWBLK	64
GUGRBOBLK	34	GUGRDWSS	34	GUGRFRFZPN	34	GUGRHESS	82	GUGRMWBLK	82
GUGRBOBLK	64	GUGRDWSS	64	GUGRFRFZPN	64	GUGRHOBK	34	GUGRMWBN	34
GUGRBOBLK	64	GUGRDWSS	82	GUGRFRFZPW	34	GUGRHOBK	64	GUGRMWBN	64
GUGRBOBLK	82	GUGREFBLK	34	GUGRFRFZPW	64	GUGRHOBK	82	GUGRMWMS	34
GUGRBOBLK	82	GUGREFBLK	64	GUGRFRFZPW	82	GUGRHOBN	34	GUGRMWMS	64
GUGRBOBN	34	GUGREFBLK	82	GUGRFRFZSS	34	GUGRHOBN	64	GUGRMWMS	82
GUGRBOBN	64	GUGREFBN	34	GUGRFRFZSS	64	GUGRHOMS	34	GUGRMWPB	34
GUGRBOMS	34	GUGREFBN	64	GUGRFRFZSS	82	GUGRHOMS	64	GUGRMWPB	64
GUGRBOMS	34	GUGREFMS	34	GUGRFRMS	34	GUGRHOMS	82	GUGRMWPN	34
GUGRBOMS	64	GUGREFMS	64	GUGRFRMS	64	GUGRHOPB	34	GUGRMWPN	64
GUGRBOMS	64	GUGREFMS	82	GUGRFRMS	82	GUGRHOPB	34	GUGRMWPW	34
GUGRBOMS	82	GUGREFPB	34	GUGRFRPB	34	GUGRHOPB	64	GUGRMWPW	64
GUGRBOMS	82	GUGREFPB	64	GUGRFRPB	64	GUGRHOPB	64	GUGRMWPW	82
GUGRBOPB	34	GUGREFPN	34	GUGRFRPN	34	GUGRHOPN	34	GUGRMWSS	34
GUGRBOPB	64	GUGREFPN	64	GUGRFRPN	64	GUGRHOPN	64	GUGRMWSS	64
GUGRBOPN	34	GUGREFPN	34	GUGRFRPW	34	GUGRHOPW	34	GUGRMWSS	82
GUGRBOPN	64	GUGREFPN	64	GUGRFRPW	64	GUGRHOPW	34	GUGROVBLK	34
GUGRBOPW	34	GUGREFPW	34	GUGRFRPW	82	GUGRHOPW	64	GUGROVBLK	64
GUGRBOPW	64	GUGREFPW	64	GUGRFRSS	34	GUGRHOPW	64	GUGROVBLK	82
GUGRBOPW	82	GUGREFPW	82	GUGRFRSS	64	GUGRHOPW	82	GUGROVBN	34
GUGRBOSS	34	GUGREFSS	34	GUGRFRSS	82	GUGRHOPW	82	GUGROVBN	64
GUGRBOSS	64	GUGREFSS	64	GUGRFZBLK	34	GUGRHOSS	34	GUGROVMS	34
GUGRBOSS	82	GUGREFSS	82	GUGRFZBLK	64	GUGRHOSS	64	GUGROVMS	64
GUGRCHBLK	34	GUGRFABLK	34	GUGRFZBLK	82	GUGRHOSS	82	GUGROVMS	82
GUGRCHBLK	64	GUGRFABLK	64	GUGRFZBN	34	GUGRJ11*MS	37	GUGROVPB	34
GUGRCHBLK	82	GUGRFABLK	82	GUGRFZBN	64	GUGRJ11*MS	67	GUGROVPB	64
GUGRCHBN	34	GUGRFABN	34	GUGRFZMS	34	GUGRJ11*MS	84	GUGROVPN	34
GUGRCHBN	64	GUGRFABN	64	GUGRFZMS	64	GUGRJ11*PB	37	GUGROVPN	64
GUGRCHMS	34	GUGRFAMS	34	GUGRFZMS	82	GUGRJ11*PB	67	GUGROVPW	34
GUGRCHMS	64	GUGRFAMS	64	GUGRFZPB	34	GUGRJ11*SS	37	GUGROVPW	64
GUGRCHMS	82	GUGRFAMS	82	GUGRFZPB	64	GUGRJ11*SS	67	GUGROVPW	82
GUGRCHPB	34	GUGRFAPB	34	GUGRFZPN	34	GUGRJ11BBN	37	GUGROVSS	34
GUGRCHPB	64	GUGRFAPB	64	GUGRFZPN	64	GUGRJ11BBN	67	GUGROVSS	64
GUGRCHPN	34	GUGRFAPN	34	GUGRFZPW	34	GUGRJ11BLK	84	GUGROVSS	82

Index

Reference	PG	Reference	PG	Reference	PG	Reference	PG	Reference	PG
GUGRPB	34	GUGRWDYMS	34	GUGS06GMS	31	GUGTELM*PB	37	INS90005	208
GUGRPB	64	GUGRWDYMS	64	GUGS06GPB	31	GUGTELM*PB	67	INS90006	208
GUGRPN	34	GUGRWDYMS	82	GUGS06GPN	31	GUGTELM*SS	37	INS90007	208
GUGRPN	64	GUGRWDYPB	34	GUGS06GPW	31	GUGTELM*SS	67	INS90008	208
GUGRPW	34	GUGRWDYPB	64	GUGS06GSS	31	GUGTELMBBN	37	INS90009	208
GUGRPW	64	GUGRWDYPN	34	GUGS08GBN	31	GUGTELMBBN	67	INS90010	208
GUGRPW	82	GUGRWDYPN	64	GUGS08GMS	31	GUGTELMBLK	84	INS90011	208
GUGRSS	34	GUGRWDYPW	34	GUGS08GPB	31	GUGTELMWPN	37	INS90502	209
GUGRSS	64	GUGRWDYPW	64	GUGS08GPN	31	GUGTELMWPN	67	INS90504	209
GUGRSS	82	GUGRWDYPW	82	GUGS08GPW	31	GUGTELMWPW	37	INS90510	209
GUGRSS	34	GUGRWDYSS	34	GUGS08GSS	31	GUGTELMWPW	67	INS90511	209
GUGRSS	64	GUGRWDYSS	64	GUGS09GBN	32	GUGTELMWPW	84	INS90513	209
GUGRSS	82	GUGRWDYSS	82	GUGS09GMS	32	GUGTELMWPW	100	INS90520	209
GUGRTDBLK	34	GUGRWMBLK	34	GUGS09GPB	32	GUGTELMWPW	166	INS90521	209
GUGRTDBLK	64	GUGRWMBLK	64	GUGS09GPN	32	GUGTELS*MS	37	INS90522	209
GUGRTDBLK	82	GUGRWMBLK	82	GUGS09GPW	32	GUGTELS*MS	67	INS90523	209
GUGRTDBN	34	GUGRWMBN	34	GUGS09GSS	32	GUGTELS*MS	84	INS91001	202
GUGRTDBN	34	GUGRWMBN	64	GUGS12GBN	32	GUGTELS*PB	37	INS91002	202
GUGRTDBN	64	GUGRWMMS	34	GUGS12GMS	32	GUGTELS*PB	67	INS91201	202
GUGRTDBN	64	GUGRWMMS	64	GUGS12GPB	32	GUGTELS*SS	37	INS91210	202
GUGRTDMS	34	GUGRWMMS	82	GUGS12GPN	32	GUGTELS*SS	67	INS91231	202
GUGRTDMS	64	GUGRWMMPB	34	GUGS12GPW	32	GUGTELSBBN	37	INS91330	202
GUGRTDMS	82	GUGRWMMPB	64	GUGS12GSS	32	GUGTELSBBN	67	INS92001	203
GUGRTDPB	34	GUGRWMMPN	34	GUGS18GBN	32	GUGTELSBLK	84	INS92002	203
GUGRTDPB	64	GUGRWMMPN	64	GUGS18GMS	32	GUGTELSWPN	37	INS92210	203
GUGRTDPN	34	GUGRWMPPW	34	GUGS18GPB	32	GUGTELSWPN	67	INS92300	203
GUGRTDPN	64	GUGRWMPPW	64	GUGS18GPN	32	GUGTELSWPW	37	INS93102	204
GUGRTDPW	34	GUGRWMPPW	82	GUGS18GPW	32	GUGTELSWPW	67	INS93111	204
GUGRTDPW	64	GUGRWMSS	34	GUGS18GSS	32	GUGTELSWPW	84	INS93120	204
GUGRTDPW	82	GUGRWMSS	64	GUGS24GBN	32	GUGTELSWPW	100	INS94001	205
GUGRTDSS	34	GUGRWMSS	82	GUGS24GMS	32	GUGTELSWPW	166	INS94002	205
GUGRTDSS	64	GUGS01GBN	30	GUGS24GPB	32	GUMSCO	97	INS94211	205
GUGRTDSS	82	GUGS01GMS	30	GUGS24GPN	32	GUMSCO	136	INS94220	205
GUGRWDBLK	34	GUGS01GPB	30	GUGS24GPW	32	GUP1411BSS	18	INS94302	205
GUGRWDBLK	64	GUGS01GPN	30	GUGS24GSS	32	GUPA1411BSS	18	INS94312	205
GUGRWDBLK	82	GUGS01GPW	30	GUGSAT*MS	38	GWP1612	181	INS95000	206
GUGRWDBN	34	GUGS01GSS	30	GUGSAT*MS	68	GWP1614	181	INS95001	206
GUGRWDBN	64	GUGS02GBN	30	GUGSAT*MS	84	GWP1622	181	INS95102	206
GUGRWDBN	64	GUGS02GMS	30	GUGSAT*MS	85	GWP1632	181	INS95104	206
GUGRWDBN	64	GUGS02GMS	30	GUGSAT*MS	85	GWP2010	181	Light Copper (LC)	109
GUGRWDBN	64	GUGS02GPB	30	GUGSAT*PB	38	GWP2011	181	Light Copper (LC)*	110
GUGRWDBN	64	GUGS02GPN	30	GUGSAT*PB	68	GWP3010	180	Light Copper (LC)*	111
GUGRWDBN	64	GUGS02GPW	30	GUGSAT*SS	38	GWP3020	180	Light Copper (LC)*	112
GUGRWDBN	64	GUGS02GSS	30	GUGSAT*SS	68	GWP3050	180	Light Copper (LC)*	114
GUGRWDPN	34	GUGS03GBN	31	GUGSATBBN	38	GWP3060	180	Light Copper (LC)*	115
GUGRWDPN	64	GUGS03GMS	31	GUGSATBBN	68	GWP9000	182	Light Copper (LC)*	116
GUGRWDPN	64	GUGS03GPB	31	GUGSATWPN	38	GWPIU3020	180	Light Copper (LC)*	117
GUGRWDPN	64	GUGS03GPN	31	GUGSATWPN	68	GWPIU3020R	180	Light Copper (LC)*	118
GUGRWDPN	82	GUGS03GPW	31	GUGSATWPN	68	GWPIU3020RP	180	Light Copper (LC)*	119
GUGRWDPN	82	GUGS03GSS	31	GUGSATWPN	68	GWPIU3050	180	Light Copper (LC)*	120
GUGRWDPN	82	GUGS04GBN	31	GUGSATWPN	84	GWPIU3060	180	LMCSKT1GR	158
GUGRWDPN	82	GUGS04GMS	31	GUGSATWPN	85	GWPIUKIT	182	LMCSKT2GR	159
GUGRWDPN	82	GUGS04GMS	31	GUGSATWPN	100	INS90001	207	LMCSKT2GRP	159
GUGRWDPN	82	GUGS04GPB	31	GUGSATWPN	166	INS90002	207	LSKT1GR	146
GUGRWDPN	82	GUGS04GPN	31	GUGTELM*MS	37	INS90003	207	LSKT2GR	146
GUGRWDPN	82	GUGS04GPW	31	GUGTELM*MS	67	INS90004	207	LSKT2GRP	146
GUGRWDPN	82	GUGS04GSS	31	GUGTELM*MS	84				
GUGRWDPN	82	GUGS06GBN	31						

Index

Reference	PG	Reference	PG	Reference	PG
Mocha Bronze (MB)	109	Satin Brass (SB)	120	SB472	173
Mocha Bronze (MB)	110	SB161	103	Stainless Steel (SS)	109
Mocha Bronze (MB)	111	SB161	121	Stainless Steel (SS)	110
Mocha Bronze (MB)	112	SB161	140	Stainless Steel (SS)	111
Mocha Bronze (MB)	114	SB161	154	Stainless Steel (SS)	112
Mocha Bronze (MB)	115	SB161	173	Stainless Steel (SS)	114
Mocha Bronze (MB)	116	SB161	41	Stainless Steel (SS)	115
Mocha Bronze (MB)	117	SB161	71	Stainless Steel (SS)	116
Mocha Bronze (MB)	118	SB161	87	Stainless Steel (SS)	117
Mocha Bronze (MB)	119	SB251	41	Stainless Steel (SS)	118
Mocha Bronze (MB)	120	SB251	71	Stainless Steel (SS)	119
MTO = made to order		SB251	87	Stainless Steel (SS)	120
MTS = made to stock	109	SB251	103	TOP133A	174
Painted White (PW)	109	SB251	121	TOP13A	174
Painted White (PW)*	110	SB251	140	TOP15AR	174
Painted White (PW)*	111	SB251	154	TOP2AR	174
Painted White (PW)*	112	SB251	173	TOP5AR	174
Painted White (PW)*	114	SB252	41	USCREW50SS	30
Painted White (PW)*	115	SB252	71	USCREW50SS	97
Painted White (PW)*	116	SB252	87	USCREW50SS	117
Painted White (PW)*	117	SB252	103	USCREW50SS	136
Painted White (PW)*	118	SB252	121	USCREW50SS	151
Painted White (PW)*	119	SB252	140	WHB320RG	187
Painted White (PW)*	120	SB252	154	WHB340RG	187
Polished Brass (PB)	109	SB252	173	WHB355RG	187
Polished Brass (PB)*	110	SB351	41	WHC363RG	187
Polished Brass (PB)*	111	SB351	71		
Polished Brass (PB)*	112	SB351	87		
Polished Brass (PB)*	114	SB351	103		
Polished Brass (PB)*	115	SB351	121		
Polished Brass (PB)*	116	SB351	140		
Polished Brass (PB)*	117	SB351	154		
Polished Brass (PB)*	118	SB351	173		
Polished Brass (PB)*	119	SB352	41		
Polished Brass (PB)*	120	SB352	71		
Polished Chrome (PC)	109	SB352	87		
Polished Chrome (PC)	110	SB352	103		
Polished Chrome (PC)	111	SB352	121		
Polished Chrome (PC)	112	SB352	140		
Polished Chrome (PC)	114	SB352	154		
Polished Chrome (PC)	115	SB352	173		
Polished Chrome (PC)	116	SB471	41		
Polished Chrome (PC)	117	SB471	71		
Polished Chrome (PC)	118	SB471	87		
Polished Chrome (PC)	119	SB471	103		
Polished Chrome (PC)	120	SB471	121		
Satin Brass (SB)	109	SB471	140		
Satin Brass (SB)	110	SB471	154		
Satin Brass (SB)	111	SB471	173		
Satin Brass (SB)	112	SB472	41		
Satin Brass (SB)	114	SB472	71		
Satin Brass (SB)	115	SB472	87		
Satin Brass (SB)	116	SB472	103		
Satin Brass (SB)	117	SB472	121		
Satin Brass (SB)	118	SB472	140		
Satin Brass (SB)	119	SB472	154		

Notes

Notes



Get the support you need...
When you need it!

Our Customer Care app provides 24/7, immediate access to technical and support information;

- > Browse FAQs for instant answers
- > Search product references and download datasheets
- > Register your product for additional benefits
- > Browse MySE for delivery and price updates *

Connect to Schneider Electric

If you cannot find what you need, you can also access phone or email support directly via the Customer Care App.



**Download the app today,
Search 'Schneider Care' on your app store**



Life Is On

Schneider
Electric

*Registered MySE account holders only

About Schneider Electric

Schneider Electric is the global specialist in energy management and automation. With revenues of ~€25 billion in FY2016, our 144,000 employees serve customers in over 100 countries, helping them to manage their energy and process in ways that are safe, reliable, efficient and sustainable. From the simplest of switches to complex operational systems, our technology, software and services improve the way our customers manage and automate their operations. Our connected technologies reshape industries, transform cities and enrich lives.

At Schneider Electric, we call this **Life Is On.**

Schneider Electric

United Kingdom
Stafford Park 5,
Telford
Shropshire
TF3 3BL
Tel: 0870 608 8 608
Fax: 0870 608 8 606

Ireland
Head office, Block A
Maynooth Business Campus
Maynooth, Co. Kildare
W23 Y7X0
Tel: 1 800 805 800
Fax: (01) 601 2201

www.schneider-electric.co.uk

www.schneider-electric.ie

